

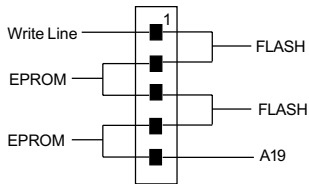

Active Cable Module - Dual 8 bit Target Interface

EPROM/FLASH Select - JP21 for JP20 (D0-7)



EPROM/FLASH Select - JP24 for JP23 (D8-15)

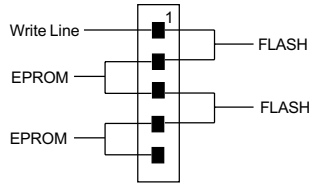

Reset Signals - JP18

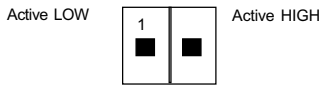

Additional Address Lines - JP22

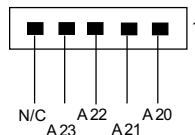

Feature Connector - JP17

Control Line 4	1	2	Status Line 4
Control Line 3	3	4	Status Line 3
Control Line 2	5	6	Status Line 2
Control Line 1	7	8	Status Line 1
Trigger Out	9	10	-
Ready Out	11	12	-
Request Out	13	14	Grant
Target Ground	15	16	-

Cable Select - JP19

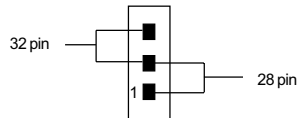

Target Cable Connector - JP20 / JP23

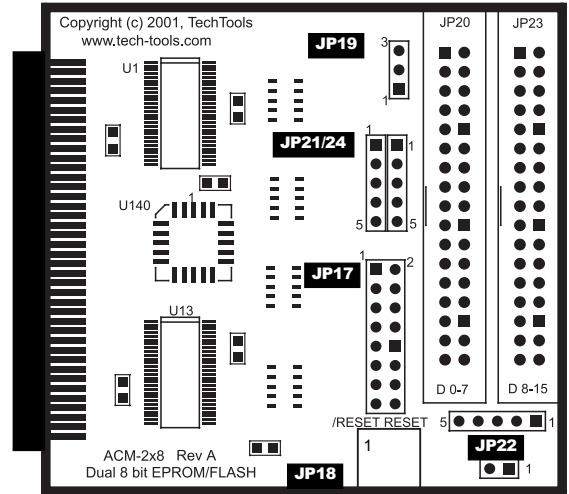

FlexROM III Connector - J4

WARNING:

Never remove or insert the ACM module when power is present. Always remove power from the emulator before changing the ACM module or Target Cable.

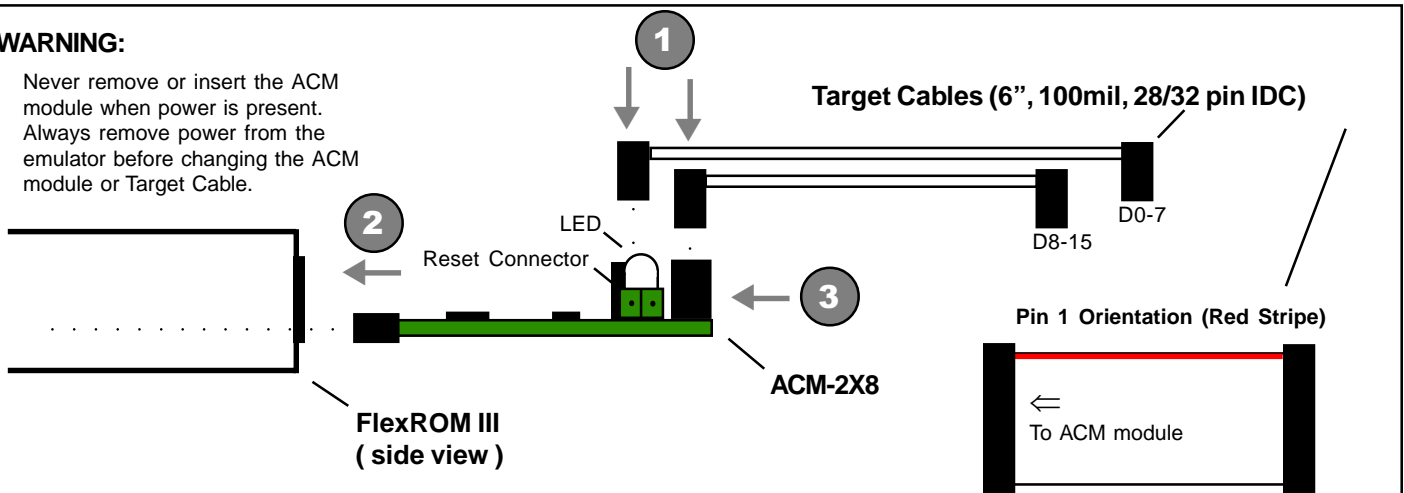

Insertion Instructions:

1. Connect the Target Cables to the ACM module.
2. Insert the ACM module into the open slot provided at the rear of the FlexROM III emulator.
3. Gently slide module into the unit until it stops. Then apply firm pressure until the ACM module seats completely.

(972) 272-9392, FAX: (972) 494-5814, sales@tech-tools.com, http://www.tech-tools.com



Active Cable Module - Dual 8 bit Target Interface

ACM-2X8 Application Note

The ACM-2X8 module allows the FlexROM III to emulate 2 memory devices simultaneously (with some limits.) In some cases, this allows you to avoid buying a second emulator.

Capabilities:

- supports byte accesses (read or write to a each device individually)
- supports word accesses (read or write to BOTH devices simultaneously)
- supports single device emulation (up to ½ the emulator's memory capacity)
- supports individual control lines (CS,OE and WT) from each device.
- Suitable for ODD/EVEN 8bit devices on a 16bit bus
- Can be used for STACKED devices (eg: 2 – 32K devices in a 64K address space) on an 8 bit bus
- Allows emulation of CODE and DATA spaces in an 8051 without needing to over-lay them.
- Each interface can be configured for EPROM or FLASH pin-outs as well as for 28 or 32 pin cables.

Limitations:

- Does NOT support reading from one device while writing to the other (writes to BOTH)
- Requires common address lines, therefore:
 - Can NOT support 2 devices in 2 separate targets
 - Can NOT support 2 devices on separate buses (full Harvard architecture)
- Must use LOWER interface when emulating a SINGLE device
- If emulating devices of differing sizes, the LARGER device must be attached to the LOWER interface.

Summary:

The ACM-2X8 can support 2 devices as long as they share the same address lines and you do not enable one device for READING while WRITING to the other. This covers most 16bit targets and many applications involving 2 devices in an 8 bit target.

If you need separate address lines or need to read from one device while writing to the other device, then you need 2 completely independent emulators. Two FlexROM III's can be daisy-chained together allowing you to connect both of them to a single printer port. Further, you can control, status and download to each emulator individually or collectively with a single command line program or our GUI software (QuickLoader.)

If you have any questions, we can be reached at:

support@tech-tools.com

FAX: 972-494-5814

Voice: 972-272-9392

(972) 272-9392, FAX: (972) 494-5814, sales@tech-tools.com, http://www.tech-tools.com