

Infrared Emitter (850 nm)

Version 1.3

SFH 4855

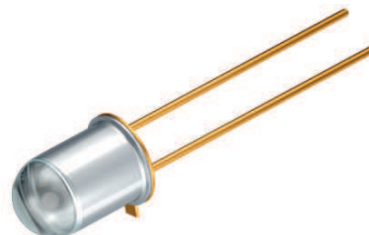

Features:

- Wavelength 850nm
- Hermetically sealed package
- Short switching times
- Spectral match with silicon photodetectors

Applications

- Photointerrupters
- Sensor technology
- Light curtains

Notes

Depending on the mode of operation, these devices emit highly concentrated non visible infrared light which can be hazardous to the human eye. Products which incorporate these devices have to follow the safety precautions given in IEC 60825-1 and IEC 62471.

Ordering Information

Type:	Radiant Intensity I_e [mW/sr] $I_F= 100 \text{ mA}, t_p= 20 \text{ ms}$	Ordering Code
SFH 4855	110 (≥ 40)	Q65111A6128
SFH 4855-VAW	63 ... 200	Q65111A9675

Note: Measured at a solid angle of $\Omega = 0.01 \text{ sr}$

Maximum Ratings ($T_A = 25\text{ °C}$)

Parameter	Symbol	Values	Unit
Operation and storage temperature range	$T_{op}; T_{stg}$	-40 ... 125	°C
Reverse voltage	V_R	5	V
Forward current	I_F	100	mA
Surge current ($t_p \leq 200\ \mu\text{s}$, $D = 0$)	I_{FSM}	1	A
Power consumption	P_{tot}	200	mW
Thermal resistance junction - ambient	R_{thJA}	500	K / W
Thermal resistance junction - case	R_{thJC}	350	K / W
ESD withstand voltage (acc. to ANSI/ ESDA/ JEDEC JS-001 - HBM)	V_{ESD}	2	kV

Characteristics ($T_A = 25\text{ °C}$)

Parameter	Symbol	Values	Unit
Peak wavelength ($I_F = 100\text{ mA}$, $t_p = 20\text{ ms}$)	λ_{peak}	860	nm
Centroid wavelength ($I_F = 100\text{ mA}$, $t_p = 20\text{ ms}$)	$\lambda_{centroid}$	850	nm
Spectral bandwidth at 50% of I_{max} ($I_F = 100\text{ mA}$, $t_p = 20\text{ ms}$)	$\Delta\lambda$	30	nm
Half angle	φ	± 8	°
Dimensions of active chip area	L x W	0.3 x 0.3	mm x mm
Distance chip surface to lens top	H	4 ... 4.8	mm
Rise and fall time of I_e (10% and 90% of $I_{e\ max}$) ($I_F = 100\text{ mA}$, $R_L = 50\ \Omega$)	t_r, t_f	12	ns
Forward voltage ($I_F = 100\text{ mA}$, $t_p = 20\text{ ms}$)	V_F	1.7 (≤ 2)	V
Forward voltage ($I_F = 1\text{ A}$, $t_p = 100\ \mu\text{s}$)	V_F	3.6 (≤ 4.6)	V
Reverse current ($V_R = 5\text{ V}$)	I_R	not designed for reverse operation	μA
Total radiant flux ($I_F = 100\text{ mA}$, $t_p = 20\text{ ms}$)	Φ_e	35	mW

Parameter		Symbol	Values	Unit
Temperature coefficient of I_e or Φ_e ($I_F = 100 \text{ mA}$, $t_p = 20 \text{ ms}$)	(typ)	TC_I	-0.3	% / K
Temperature coefficient of V_F ($I_F = 100 \text{ mA}$, $t_p = 20 \text{ ms}$)	(typ)	TC_V	-0.6	mV / K
Temperature coefficient of wavelength ($I_F = 100 \text{ mA}$, $t_p = 20 \text{ ms}$)	(typ)	TC_λ	0.3	nm / K

Grouping ($T_A = 25 \text{ }^\circ\text{C}$)

Group	Min Radiant Intensity	Max Radiant Intensity	Typ Radiant Intensity
	$I_F = 100 \text{ mA}$, $t_p = 20 \text{ ms}$ $I_{e, \text{min}}$ [mW / sr]	$I_F = 100 \text{ mA}$, $t_p = 20 \text{ ms}$ $I_{e, \text{max}}$ [mW / sr]	$I_F = 1 \text{ A}$, $t_p = 100 \text{ } \mu\text{s}$ $I_{e, \text{typ}}$ [mW / sr]
SFH 4855-U	40	80	250
SFH 4855-V	63	125	400
SFH 4855-AW	100	200	630
SFH 4855-BW	160	320	980

Note: measured at a solid angle of $\Omega = 0.01 \text{ sr}$

Only one group in one packing unit (variation lower 2:1).

Relative Spectral Emission ^{1) page 9}

$I_{rel} = f(\lambda), T_A = 25^\circ\text{C}$

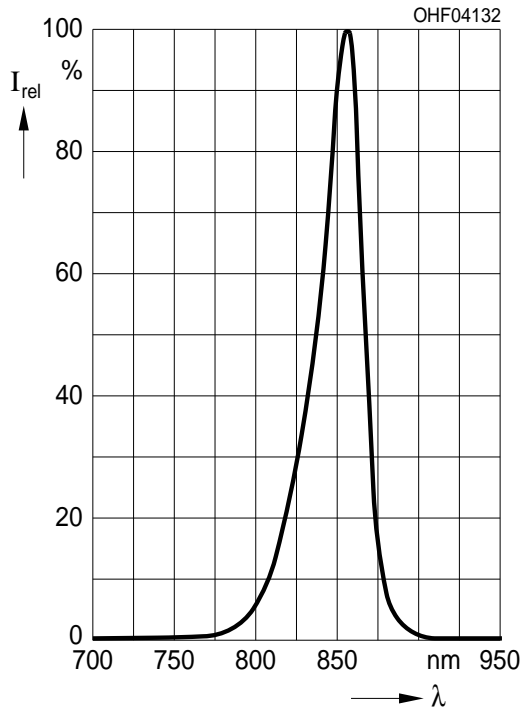

Radiant Intensity ^{1) page 9}

$I_e / I_e(100 \text{ mA}) = f(I_F), \text{ single pulse, } t_p = 100 \mu\text{s}, T_A = 25^\circ\text{C}$

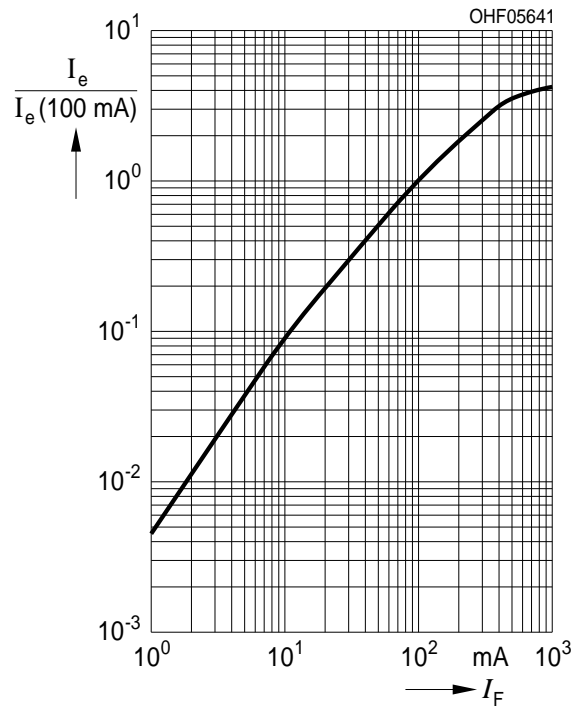

Max. Permissible Forward Current

$I_{F, max} = f(T_A), R_{thJA} = 500 \text{ K/W}$

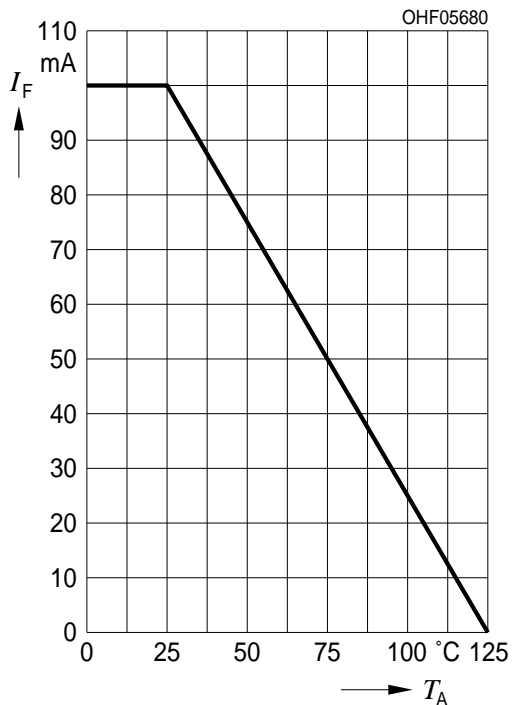

Forward Current ^{1) page 9}

$I_F = f(V_F), \text{ single pulse, } t_p = 100 \mu\text{s}, T_A = 25^\circ\text{C}$

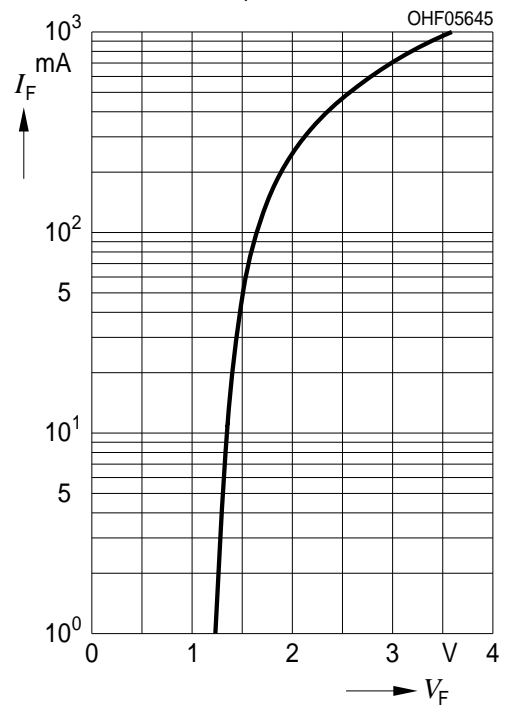

Permissible Pulse Handling Capability

$I_F = f(t_p)$, $T_A = 25\text{ °C}$, duty cycle $D =$ parameter

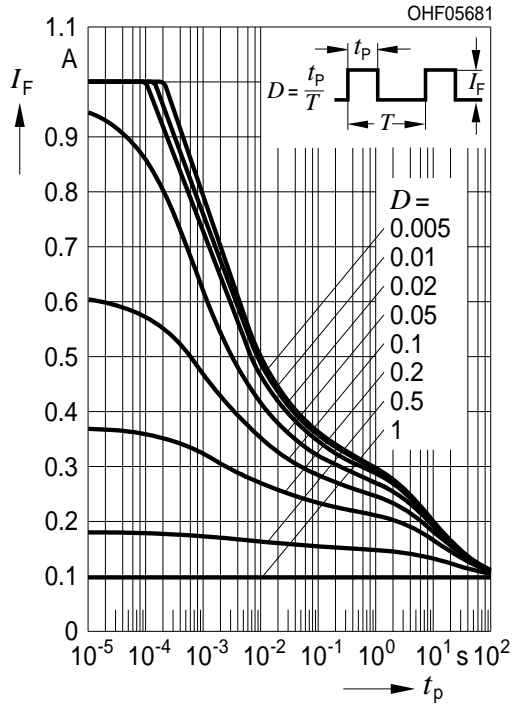

Permissible Pulse Handling Capability

$I_F = f(t_p)$, $T_A = 85\text{ °C}$, duty cycle $D =$ parameter

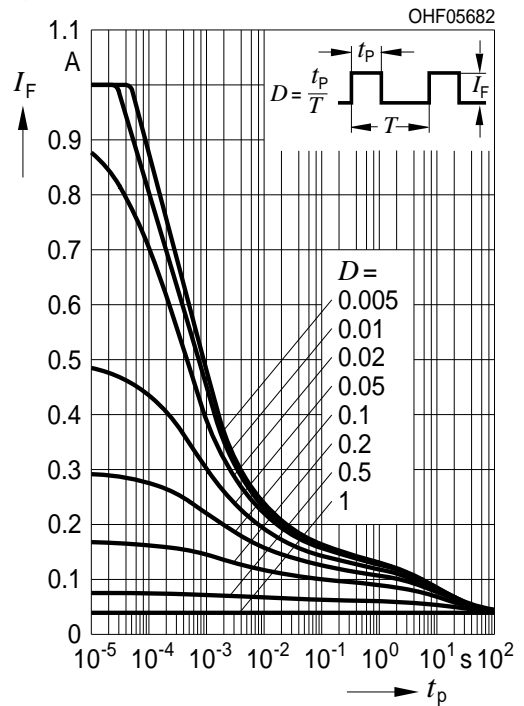

Radiation Characteristics ^{1) page 9}

$I_{rel} = f(\phi)$, $T_A = 25\text{ °C}$

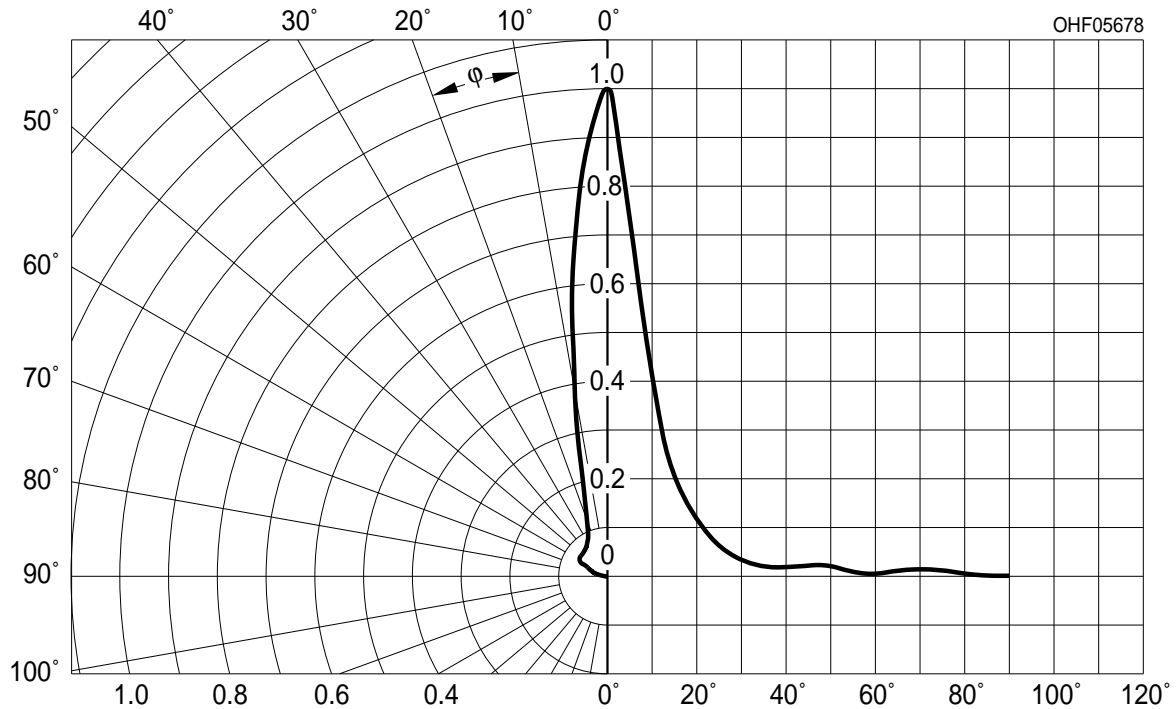

Package Outline

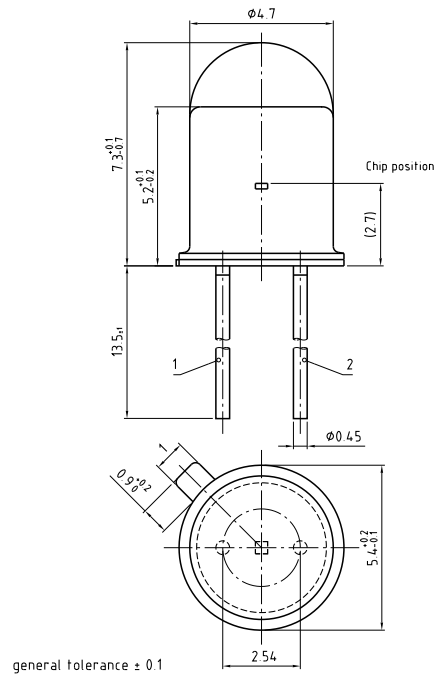

C63062-A4266-A1-02

Dimensions in mm.

Pinning

Pin	Description
1	Cathode
2	Anode

Package

Metal Can (TO-18), hermetically sealed

Approximate Weight:

0.4 g

Recommended Solder Pad



E062.3010.188-01

Dimensions in mm.

Note:

pad 1: cathode

TTW Soldering

IEC-61760-1 TTW



Disclaimer

Language english will prevail in case of any discrepancies or deviations between the two language wordings.

Attention please!

The information describes the type of component and shall not be considered as assured characteristics.

Terms of delivery and rights to change design reserved. Due to technical requirements components may contain dangerous substances.

For information on the types in question please contact our Sales Organization.

If printed or downloaded, please find the latest version in the Internet.

Packing

Please use the recycling operators known to you. We can also help you – get in touch with your nearest sales office.

By agreement we will take packing material back, if it is sorted. You must bear the costs of transport. For packing material that is returned to us unsorted or which we are not obliged to accept, we shall have to invoice you for any costs incurred.

Components used in life-support devices or systems must be expressly authorized for such purpose!

Critical components* may only be used in life-support devices** or systems with the express written approval of OSRAM OS.

*) A critical component is a component used in a life-support device or system whose failure can reasonably be expected to cause the failure of that life-support device or system, or to affect its safety or the effectiveness of that device or system.

**) Life support devices or systems are intended (a) to be implanted in the human body, or (b) to support and/or maintain and sustain human life. If they fail, it is reasonable to assume that the health and the life of the user may be endangered.

Glossary

- ¹⁾ **Typical Values:** Due to the special conditions of the manufacturing processes of LED, the typical data or calculated correlations of technical parameters can only reflect statistical figures. These do not necessarily correspond to the actual parameters of each single product, which could differ from the typical data and calculated correlations or the typical characteristic line. If requested, e.g. because of technical improvements, these typ. data will be changed without any further notice.

Published by OSRAM Opto Semiconductors GmbH
Leibnizstraße 4, D-93055 Regensburg
www.osram-os.com © All Rights Reserved.

EU RoHS and China RoHS compliant product



此产品符合欧盟 RoHS 指令的要求；
按照中国的相关法规和标准，不含有毒有害物质或元素。