

ACT4525 EVK User's Guide

5V/3.4A Dual Output CV/CC Car Charger Solution

Features

- Wide input voltage range from 6V to 32V
- Transparent input voltage surge up to 40V
- 5.1V output voltage
- 4.75V-5.25V during input and load transients
- 125kHz switching frequency
- Standby input current <2mA
- 2.4A+1A dual output with separate CC regulation
- USB Auto-detect Support Apple, Samsung and BC1.2
- Good EMC performance
- Under voltage protection at output short
- <6mA average output current at output short
- Output over voltage protection
- Output cord compensation
- Thermal shutdown protection

Specification

DESCRIPTION	CONDITION	MIN	TYP	MAX	UNITS
Input Voltage		6		36	V
Switching Frequency			125		kHz
Standby Input current	Vin=10V, no load		2		mA
	Vin=24V, no load		1		mA
Output Voltage	No cable, full load range	4.85	5.1	5.25	V
Output1 current limit range		2400	2650	2700	mA
Output2 current limit range		1050	1200	1350	mA
Ripple Voltage	Vin=10V, Iout1=2.4A, Iout2=1A		45		mV
	Vin=24V, Iout1=2.4A, Iout2=1A		55		
Efficiency at full load	Vin=10V, Iout1=2.4A, Iout2=1A		89		%
	Vin=24V, Iout1=2.4A, Iout2=1A		88		%
ENVIRONMENTAL					
ESD	Contact		4		kV
	Through air		8		kV

TABLE OF CONTENTS

Features	1
Specification	1
Introduction	3
Demo Board Photos	3
PCB Layout	4
Schematics	5
Bill of Materials	5
Equipment And EVK Test Setup.....	7
.....	7
Functional Test.....	7
Output1 Regulation	7
Output2 Regulation	8
Efficiency (Ta=25°C).....	8
Power Loss	9
Output1 Constant Current and Constant Voltage (Ta=25°C)	9
Output2 Constant Current and Constant Voltage (Ta=25°C)	10
Standby Input Current and Power loss	10
Ripple and Noise	11
Load Transient Response.....	12
Line Transient Response(Vin change from 12V to 40V, 1V/us).....	14
Key Components Temperature Test (Ta=40°C, burning for 2 hours).....	14
EMI TEST	15
Radiated EMI Test	15

Introduction

This document supports both the ACT4525YH-T Evaluation Kit (EA4525YH-T) and ACT4525YH-T0001 Evaluation Kit (EA4525YH-T0001). These kits are used for car charger, rechargeable portable device and so on. The EVKs operate at very high charge efficiency of 89%. They contain a dual USB output that provides outputs with 5V/2.4A and 5V/1A. Both EVKs are identical except for the IC. The ACT4525YH-T output cord compensation is 100mV while the ACT4525YH-T0001 output cord compensation is 200mV.

Demo Board Photos

Top layer



Bottom layer



PCB Layout

Top layer

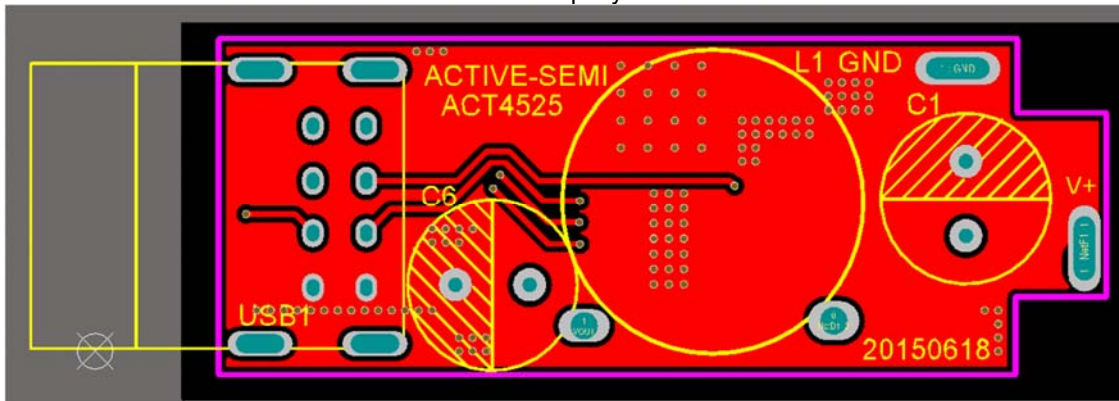

Bottom layer

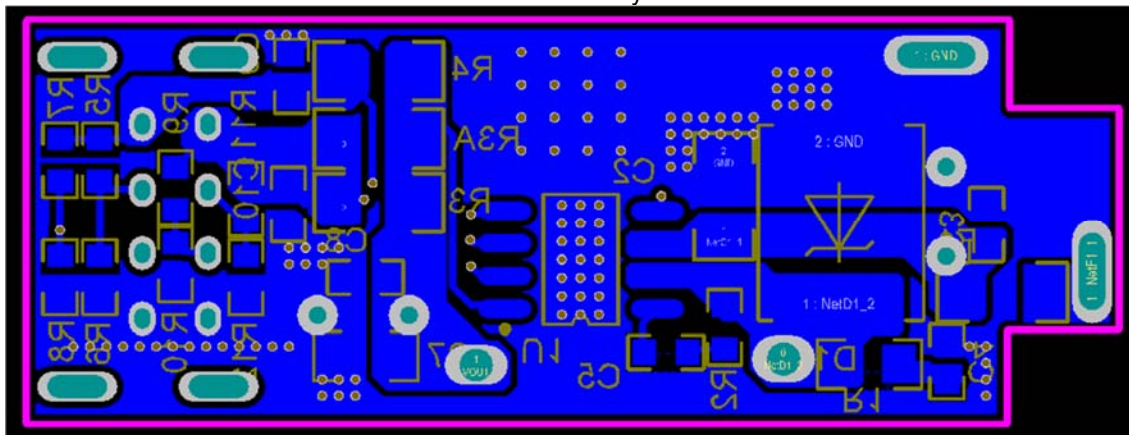

Schematics

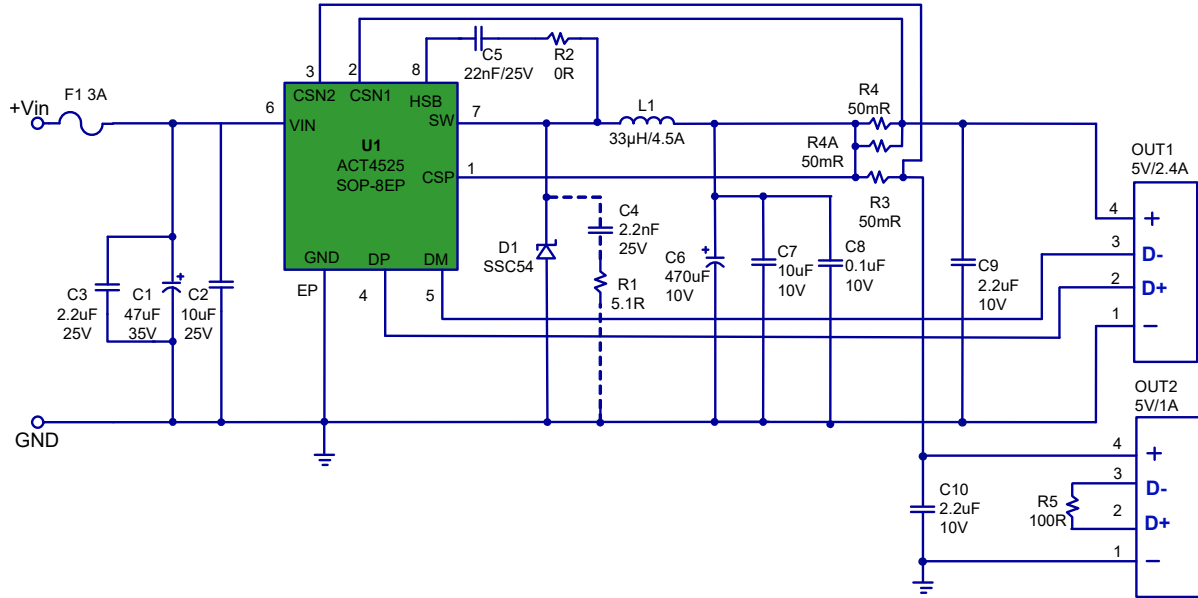

Bill of Materials

Item	Reference	Description	QTY		Manuf.
			EA4525YH-T	EA4525YH-T0001	
1	L1	Choke Coil, Dip, T11.5*5*4mm, phi=0.8mm, L=33uH	1	1	
2	D1	Schottky Diode, SSC54,40V/5A, SMC	1	1	Vishay
3	C1	Electrolytic capacitor,47uF/35V,6.3x8mm	1	1	Koshin
4	C2	Ceramic capacitor,10uF/25V, X7R,1206	1	1	Koshin
5	C3	Ceramic capacitor,2.2uF/25V, X7R,0805	1	1	Murata/TKD
6	C4	Ceramic capacitor, 2.2nF/25V, X7R,0603(optional)	1	1	Murata/TKD
7	C5	Ceramic capacitor, 22nF/25V, X7R, 0603	1	1	Murata/TKD
8	C6	Electrolytic capacitor,470uF/10V,7x11.5mm	1	1	Murata/TKD
9	C7	Ceramic capacitor, 10uF/10V, X7R, 0805	1	1	Murata/TKD
10	C8	Ceramic capacitor, 0.1uF /25V, X7R, 0603	1	1	Murata/TKD
11	C9/C10	Ceramic capacitor, 2.2uF/10V, X7R, 0805	2	2	Murata/TKD
12	F1	Fuse,3A,1206 (Replaced by 0Ω 0805 chip resistor)	1	1	Murata/TKD
13	R1	Chip Resistor, 5.1Ω, 1/10W, 5%, 0603(optional)	1	1	Murata/TKD
14	R2	Chip Resistor, 0Ω, 1/10W, 5%, 0603	1	1	Murata/TKD
15	R3/R3A/R4	Chip Resistor, 50mΩ, 1/4W, 1%, 1206	1	1	Murata/TKD
16	R5	Chip Resistor, 100Ω, 1/16W ,1%,0603	1	1	Murata/TKD
17	U1	IC, ACT4525YH-T,SOP-8-EP	1	0	ACT
18	U1	IC, ACT4525YH-T0001,SOP-8-EP	0	1	ACT
19	USB2.0	USB AF 90 degree double half double bomb	1	1	HLW

Equipment and EVK Test Setup

Equipment	Model
DC Load	PRODIGIT 3311F 60V/60A,300W DC ELECTRONIC LOAD
DC Power Supply	GW INSTEK GPC-30600
Multi Meter	FLLIKE 8808A 5-1/2 DIGIT MULTIMETER
Oscilloscope	Tektronix DPO 3014 Digital Phosphor Oscilloscope

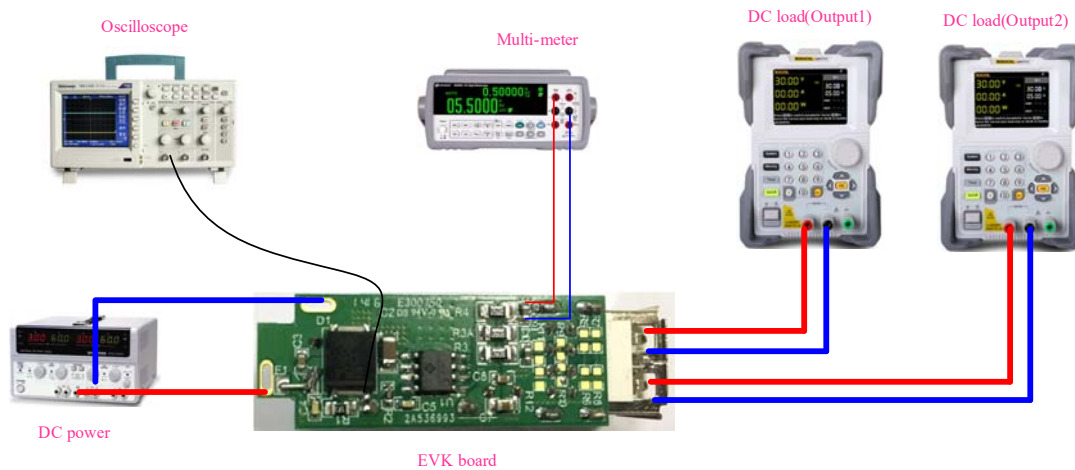

Functional Test

Output1 Regulation

$V_{in}=12V$. $I_{out2}=0A$. Set DC load (Output1) in CC mode. Increase I_{out1} from 0A to 2.4A and measure the voltage on the C7 capacitor.

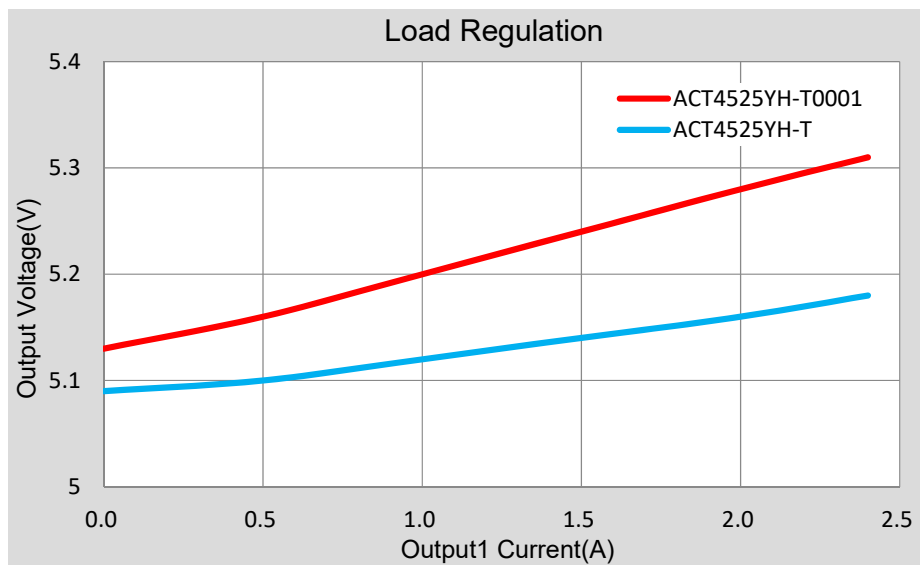

Output2 Regulation

Vin=12V. Iout1=0A. Set DC load (Output2) in CC mode. Increase Iout2 from 0A to 1A and measure the voltage on the C7 capacitor.

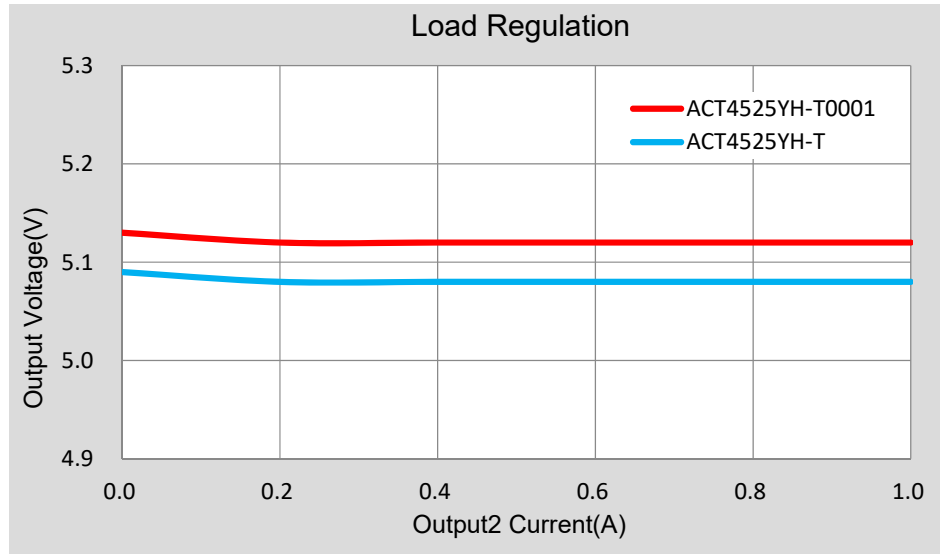

Efficiency (Ta=25°C)

Increase Iout1 from 0A to 2.4A then increase Iout1 from 0A to 1A and measure the efficiency of the evaluation kit in different input voltage.

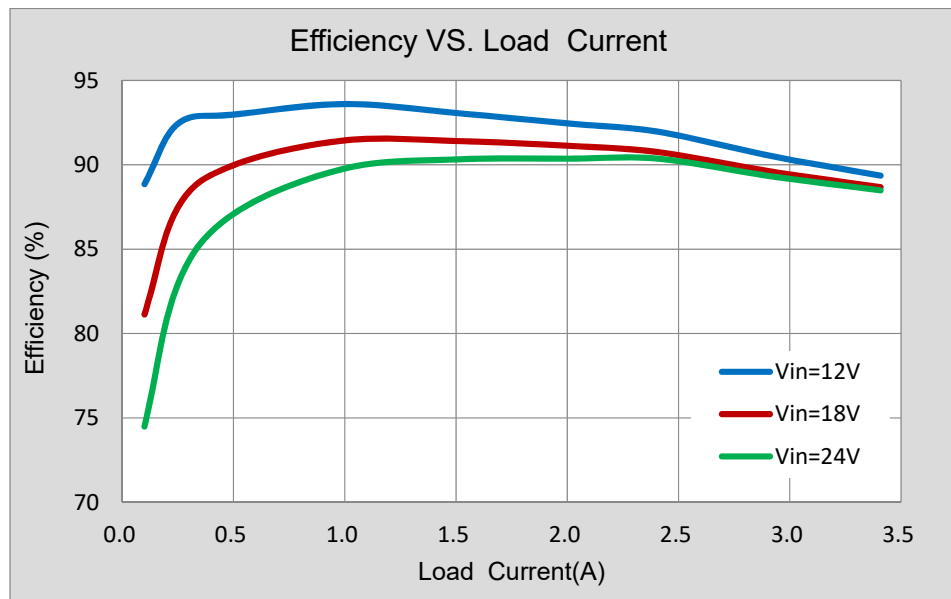

Power Loss

Increase Iout1 from 0A to 2.4A then increase Iout1 from 0A to 1A and measure the power loss of the evaluation kit in different input voltage.

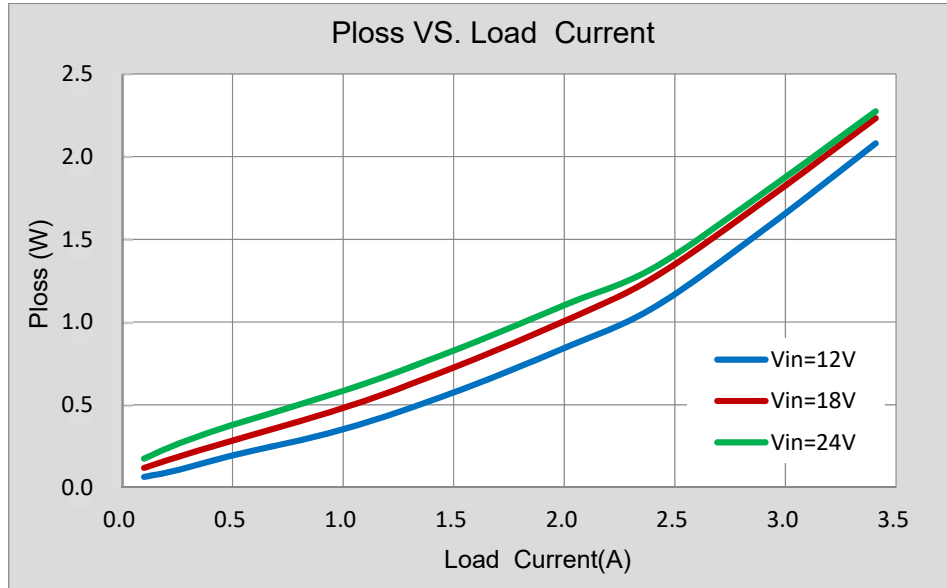

Output1 Constant Current and Constant Voltage (Ta=25°C)

Vin=12V. Iout2=0A. Set DC load (Output1) in CV mode. Increase Vout1 from 0V to the maximum load voltage. Measure the current of output1 and the voltage on the C7 capacitor. Then set DC load (Output1) in CC mode, increase Iout1 from 0A to the maximum load current and measure the voltage on the C7 capacitor.

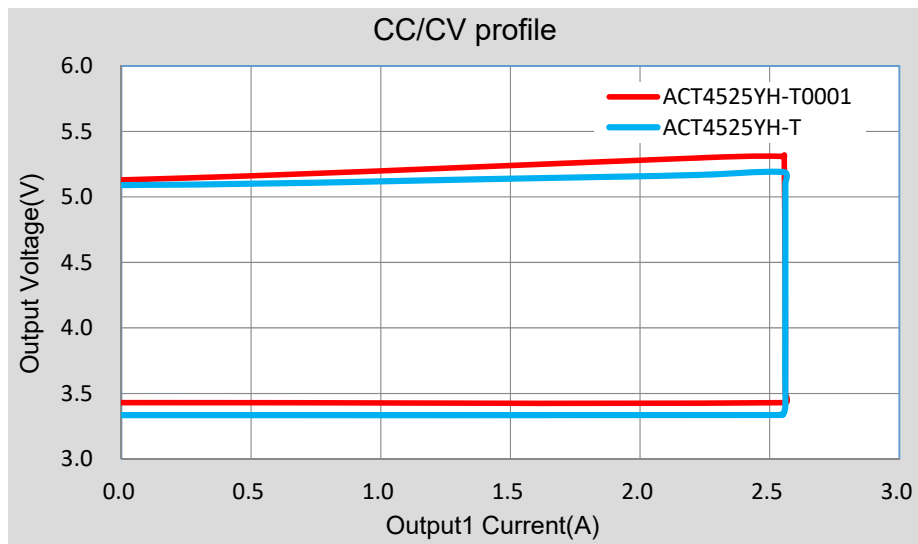

Output2 Constant Current and Constant Voltage (Ta=25°C)

Vin=12V, Iout1=0A. Set DC load (Output2) in CV mode. Increase Vout2 from 0V to the maximum load voltage. Measure the current of output2 and the voltage on the C7 capacitor. Then Set DC load (Output1) in CC mode, increase Iout2 from 0A to the maximum load current and measure the voltage on the C7 capacitor. Change the IC of the board from ACT4525YH-T to ACT4525YH-T0001 and repeat the above operation.

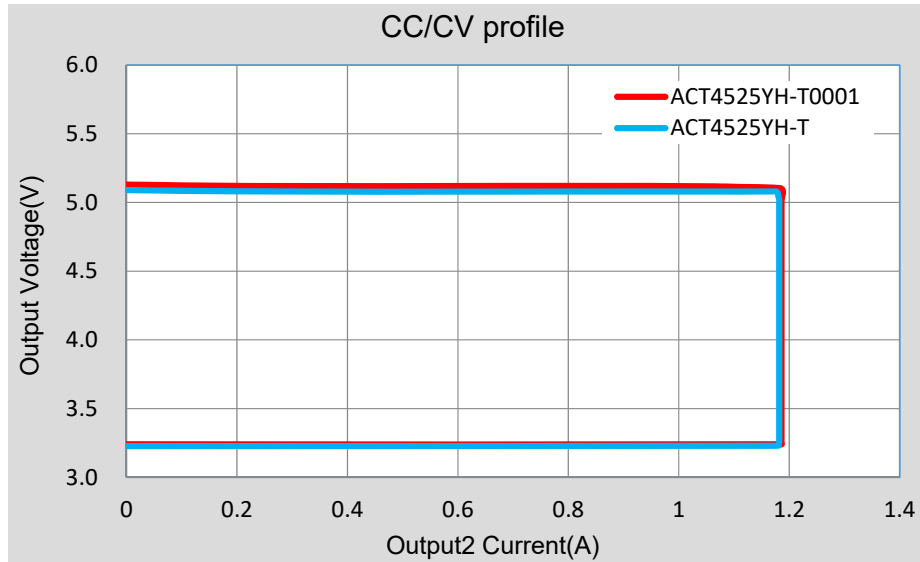
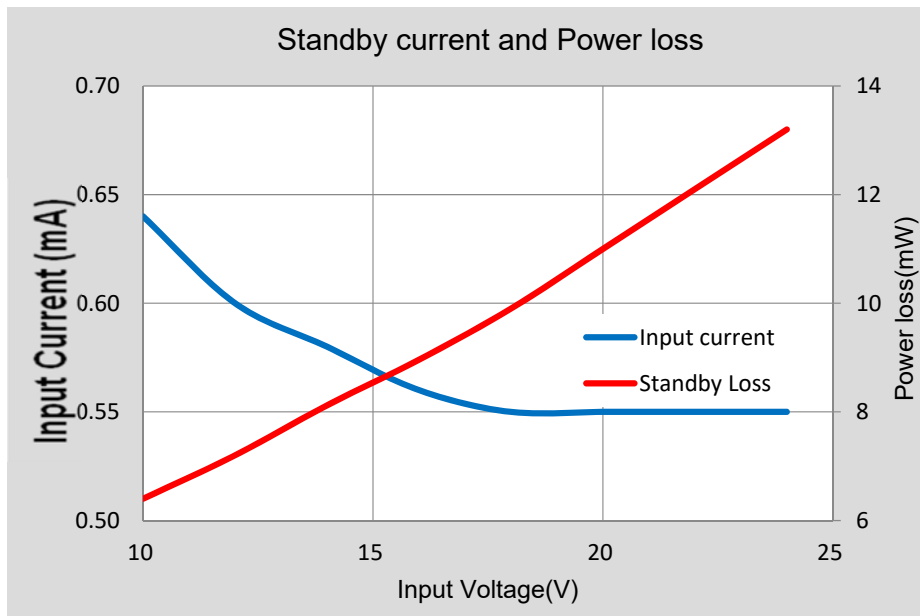
Standby Input Current and Power loss

Ripple and Noise

CH1:Vout1, CH2:Vout2, CH3:Vsw

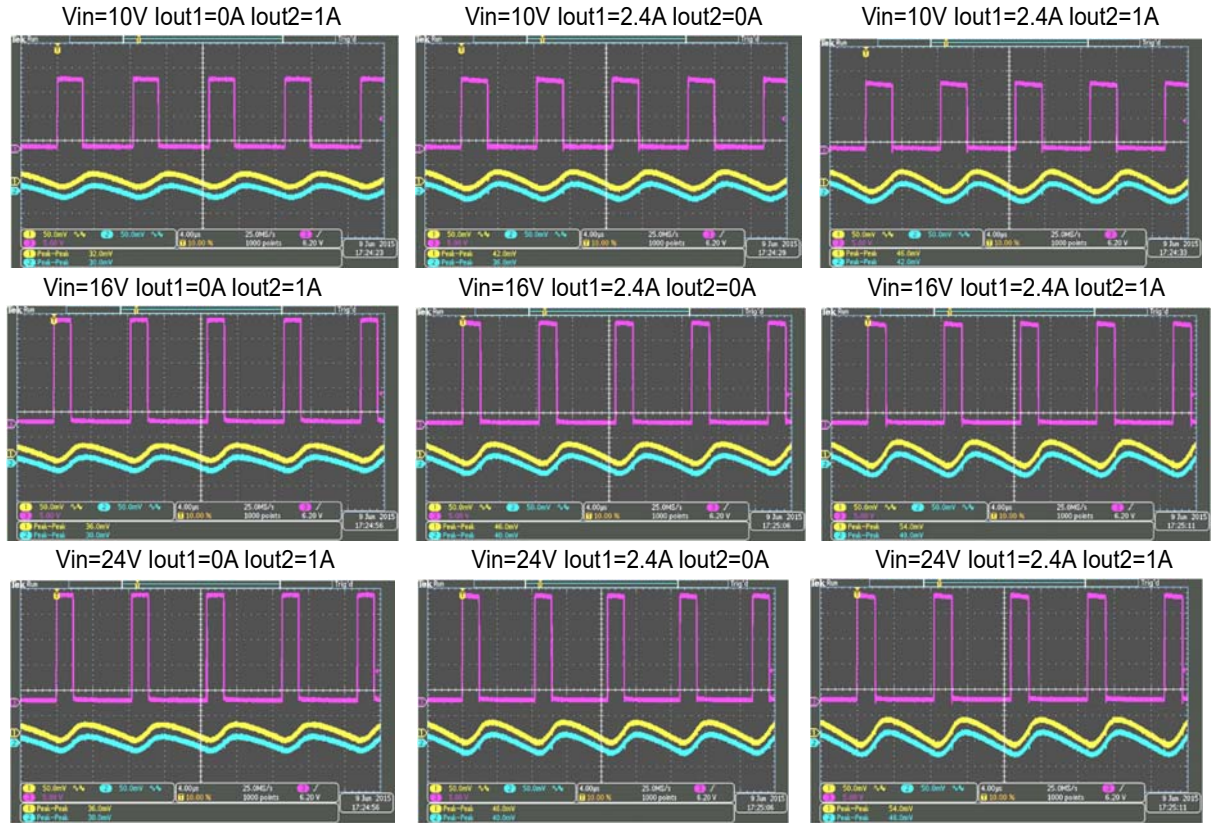

Ripple & noise are measured by using 20MHz bandwidth limited oscilloscope.

Test Conditions	lout1=0A, lout2=1A		lout1=2.4A, lout2=0A		lout1=2.4A, lout2=1A	
	Vout1(mV)	Vout2(mV)	Vout1(mV)	Vout2(mV)	Vout1(mV)	Vout2(mV)
Vin=10V	32	30	42	36	46	42
Vin=16V	36	30	46	40	54	48
Vin=24V	36	30	46	40	54	48

Load Transient Response

CH1:Vout1, CH2:Vout2, CH4:Iout
Iout2=0A dynamic load on output1

Vin=10V, load step 0A-0.5A-0A

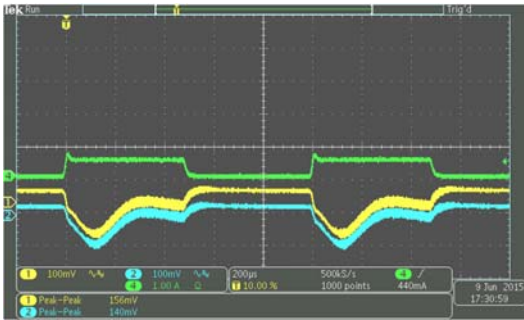

Vin=10V, load step 0.5A-1A-0.5A

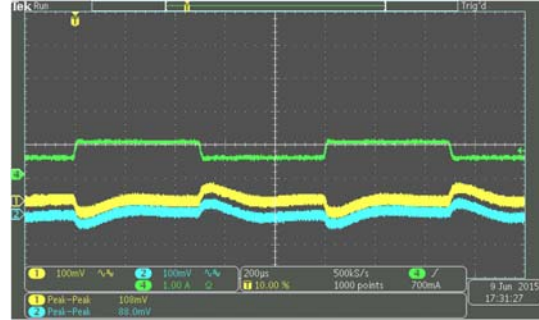

Vin=10V, load step 1A-1.5A-1A

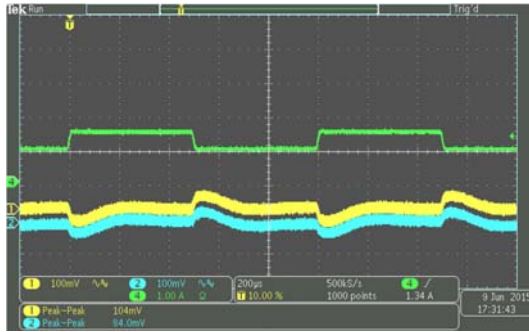

Vin=10V, load step 1.5A-2.4A-1.5A

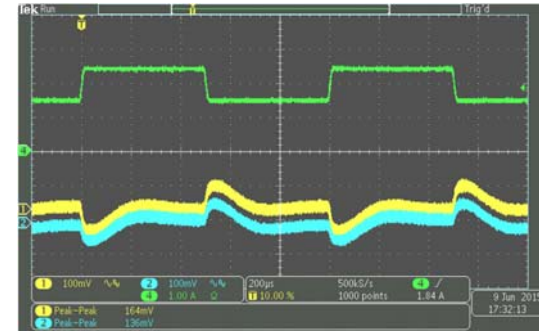

Iout2=1A dynamic load on output1

Vin=10V, load step 0A-0.5A -0A

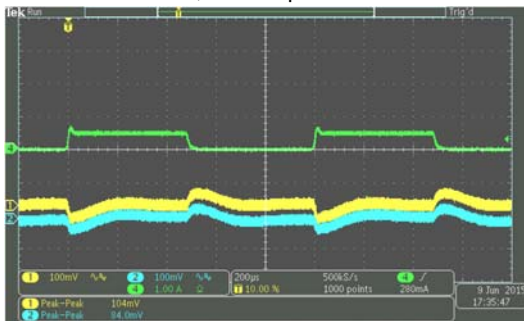

Vin=10V, load step 0.5A-1A-0.5A

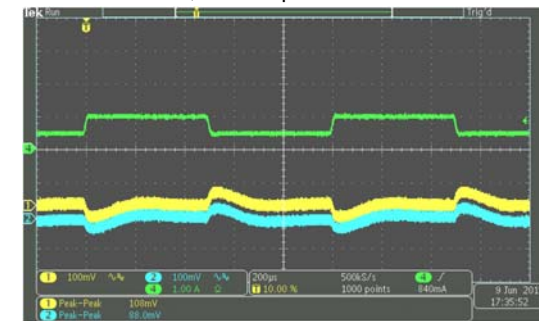

Vin=10V, load step 1A-1.5A-1A

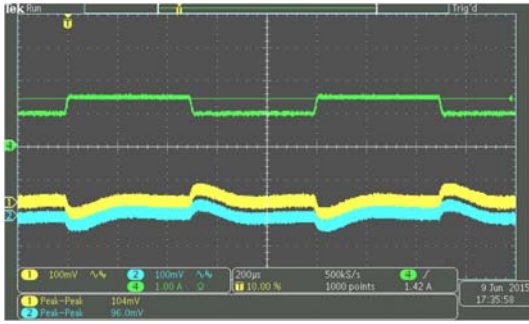

Vin=10V, load step 1.5A-2.4A-1.5A

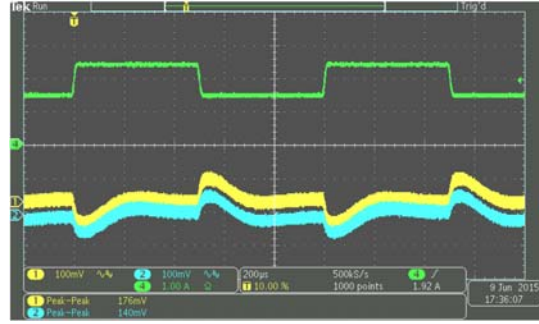

Iout2=0A dynamic load on output1

Vin=24V, load step 0A-0.5A-0A

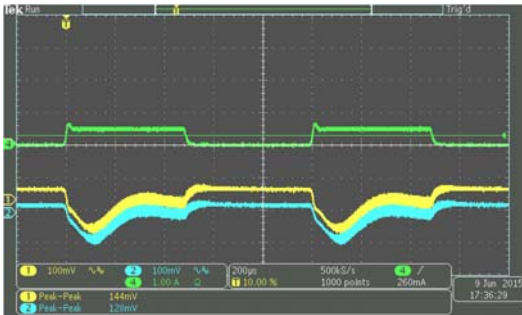

Vin=24V, load step 0.5A-1A-0.5A

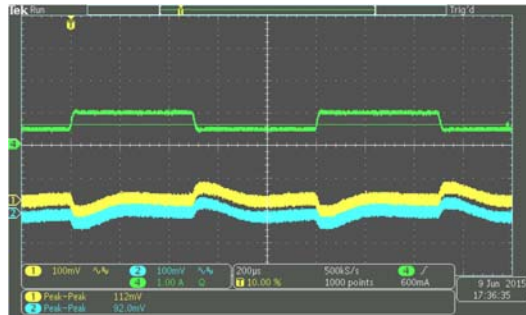

Vin=24V, load step 1A-1.5A-1A

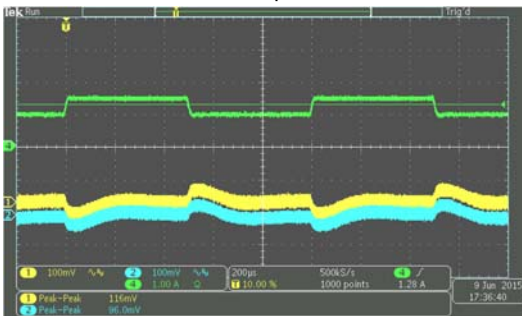

Vin=24V, load step 1.5A-2.4A-1.5A

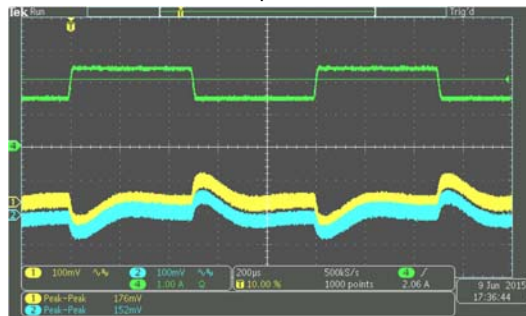

Iout2=1A dynamic load on output1

Vin=24V, load step 0A-0.5A -0A

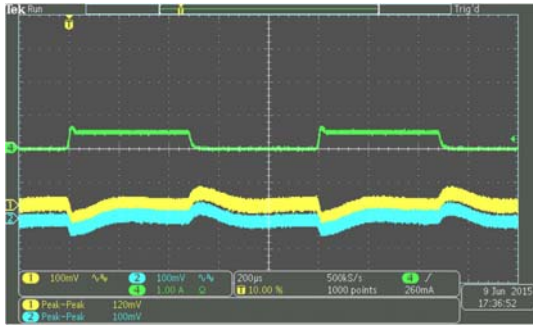

Vin=24V, load step 0.5A-1A-0.5A

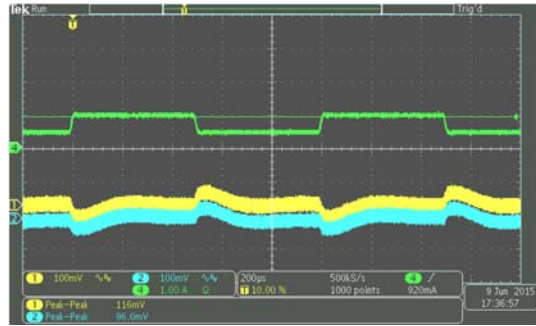

Vin=24V, load step 1A-1.5A-1A

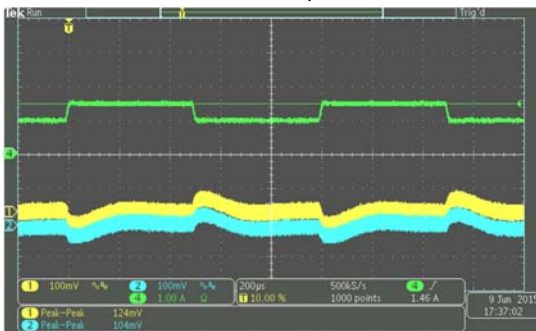

Vin=24V, load step 1.5A-2.4A-1.5A

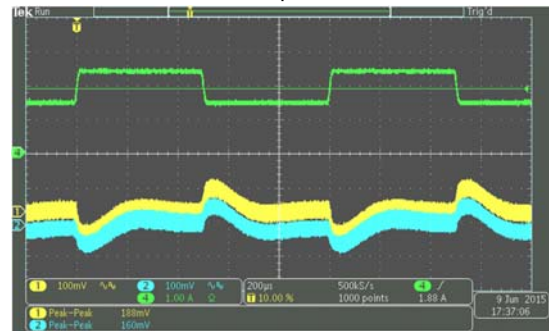

Line Transient Response(Vin change from 12V to 40V, 1V/us)

CH1:Vin, CH2:Vout1,CH3:Vout2

Iout1=0A,Iout2=1A

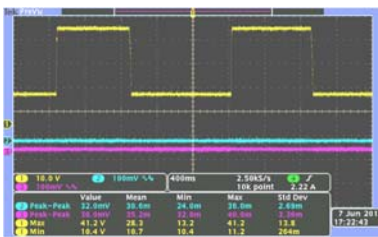

Iout1=2.4A,Iout2=0A



Iout1=2.4A,Iout2=1A



Key Components Temperature Test (Ta=40°C, after 2 hours steady state operation at full load)

Vin/Iout	Components temperature(°C)				
	Ambient	PCB	IC	Diode	Inductor
12V/3.4A	44.5	84.1	106.2	103.8	96.3
24V/3.4A	46.2	90	114.9	116.5	106.5



EMI TEST

Radiated EMI Test

Vin=12V Io=3.4A Horizontal

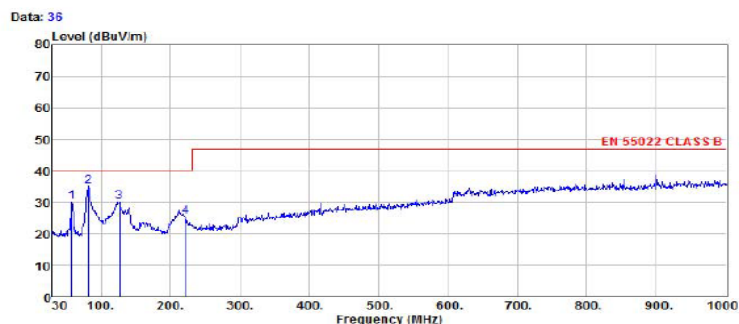

Site : chamber
 Condition : EN 55022 CLASS B 3m VULB9160 HORIZONTAL
 EUT :
 Model Name : 16
 Temp/Humi : 25°C / 53 %
 Power Rating: AC 230V/50Hz
 Mode :
 Memo :

	Freq	ReadAntenna	Cable	Preamp	Level	Limit	Over		Factor
	MHz	dBuV	dB/m	dB	dB	dBuV/m	dBuV/m	dB	dB/m
1	57.16	16.48	12.49	1.02	0.00	29.99	40.00	-10.01	Peak 13.51
2	81.41	25.42	8.73	1.09	0.00	35.24	40.00	-4.76	Peak 9.82
3	125.03	16.20	12.39	1.55	0.00	30.14	40.00	-9.86	Peak 13.94
4	221.09	12.65	10.76	2.11	0.00	25.52	40.00	-14.48	Peak 12.87

Vin=12V Io=3.4A Vertical

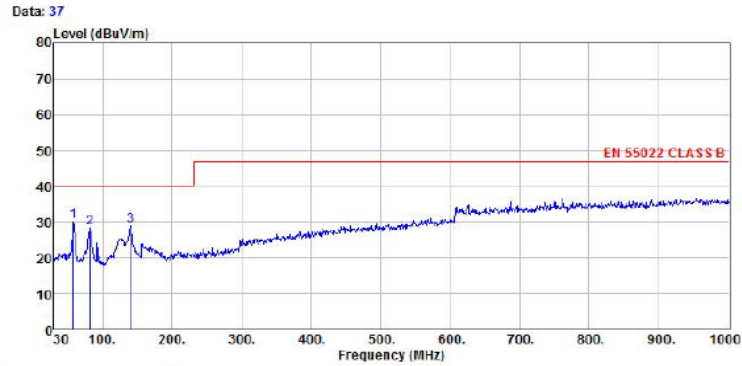

Site : chamber
 Condition : EN 55022 CLASS B 3m VULB9160 VERTICAL
 EUT :
 Model Name : 16
 Temp/Humi : 25°C / 53 %
 Power Rating: AC 230V/50Hz
 Mode :
 Memo :

	Freq	ReadAntenna Level	Antenna Factor	Cable Loss	Preamp Factor	Level	Limit Line	Over Limit	Remark	Factor	
	MHz	dBuV	dB/m	dB	dB	dBuV/m	dBuV/m	dB		dB/m	
1	pp	57.16	16.72	12.49	1.02	0.00	30.23	40.00	-9.77	Peak	13.51
2		81.41	18.41	8.73	1.09	0.00	28.23	40.00	-11.77	Peak	9.82
3		140.58	13.90	13.47	1.62	0.00	28.99	40.00	-11.01	Peak	15.09