

## Features

Package	2125 (t=0.8mm) type, Milky white epoxy lens Emitting color : Orange
Product features	<ul style="list-style-type: none"> <li>• Outer dimension 2.0 x 1.25 x 0.8mm ( L x W x H )</li> <li>• Lead-free soldering compatible</li> <li>• RoHS compliant</li> </ul>

## Recommended Applications

- Telecommunication equipment, Consumer electronics, OA/FA, other general applications

# Outline Dimensions

**FKA1112H-TR**

Unit : mm  
Weight : 2.84mg  
Tolerance : ±0.1

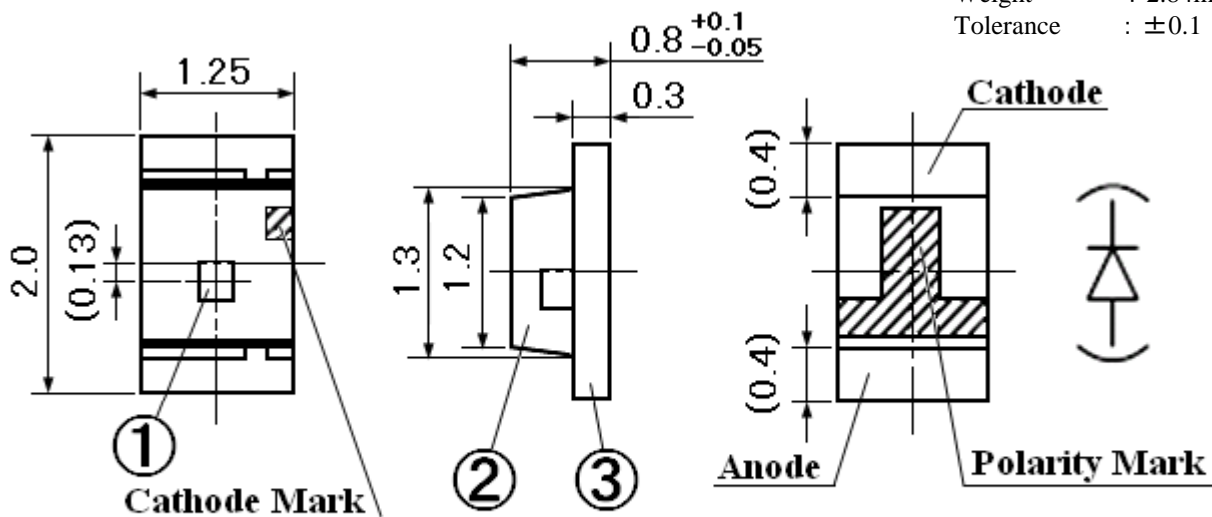

**Notes**

1. Outline Dimensions do not include the size of cutting burr around substrate and pin(electrodes)
2. Be careful not to get short circuit if wire is set between soldering pads.

NO.	PART NAME	MATERIAL	QTY.
①	LED Die	AlGaInP	1
②	Lens	Epoxy Resin	1
③	Substrate	Glass Fabrics	1

# Recommended Pad

Unit : mm

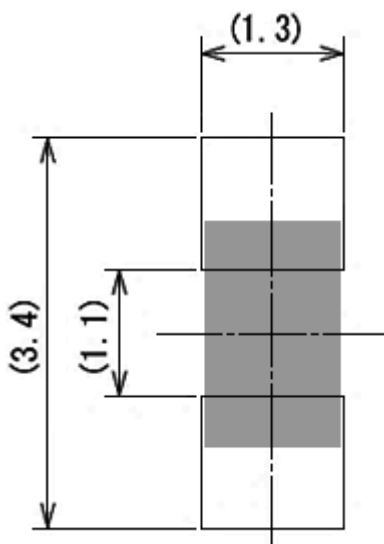

## 【 Product Overview 】

Die Material	AlGaInP
Emitting Color	Orange
Resin Color 【Emitting Area】	Milky White

## 【 Absolute Maximum Ratings 】

(Ta=25°C)

ITEM	SYMBOL	MAXIMUM RATINGS	UNITS
Power Dissipation	Pd	84	mW
Forward Current	I <sub>F</sub>	30	mA
Repetitive Peak Forward Current "1ms, 1/20duty"	I <sub>FRM</sub>	100	mA
IF Derate Linearly from "25°C"	ΔI <sub>F</sub>	0.4	mA/°C
IFRM Derate Linearly from "25°C"	ΔI <sub>FRM</sub>	1.33	mA/ °C
Reverse Voltage	V <sub>R</sub>	5	V
Operating Temperature	Topr	-40 ~ +85	°C
Storage Temperature	Tstg	-40 ~ +100	°C
Soldering Temperature "Reflow Soldering"	Tsld	260	°C

※

※Please refer to page 8, Soldering Conditions.

## 【 Electro and Optical Characteristics 】

(Ta=25°C)

ITEM	SYMBOL	CONDITIONS	MIN.	TYP.	MAX.	UNITS
Forward Voltage	V <sub>F</sub>	I <sub>F</sub> = 20mA	-	2.1	2.6	V
Reverse Current	I <sub>R</sub>	V <sub>R</sub> = 5V	-	-	100	μA
Luminous Intensity	I <sub>V</sub>	I <sub>F</sub> = 20mA	220	350	680	mcd
Peak Wavelength	λ <sub>p</sub>	I <sub>F</sub> = 20mA	-	612	-	nm
Dominant Wavelength	λ <sub>d</sub>	I <sub>F</sub> = 20mA	597	605	612	nm
Spectral Line Half Width	Δλ	I <sub>F</sub> = 20mA	-	20	-	nm

Note: Above Intensity (I<sub>V</sub>) values and Dominant Wavelength (λ<sub>d</sub>) values are the setup value of the selection machine. 【Tolerance : I<sub>V</sub>... ± 10%, λ<sub>d</sub>... ± 1nm】

## 【 Sorting For Luminous Intensity and Dominant Wavelength 】

LEDs shall be sorted out into the following ranks of Luminous Intensity and Dominant Wavelength.

Luminous Intensity ( $I_v$ ) Rank

Rank	$I_v$ (mcd)		CONDITIONS
	MIN.	MAX.	
CC	220	330	$I_F = 20\text{mA}$ $T_a = 25^\circ\text{C}$
CD	330	470	
CE	470	680	

Dominant Wavelength ( $\lambda_d$ ) Rank

Rank	$\lambda_d$ (nm)		CONDITIONS
	MIN.	MAX.	
A	597	600	$I_F = 20\text{mA}$ $T_a = 25^\circ\text{C}$
B	600	603	
C	603	606	
D	606	609	
E	609	612	

Note: Above Intensity ( $I_v$ ) values and Dominant Wavelength ( $\lambda_d$ ) values are the setup value of the selection machine. 【Tolerance :  $I_v \dots \pm 10\%$ ,  $\lambda_d \dots \pm 1\text{nm}$ 】

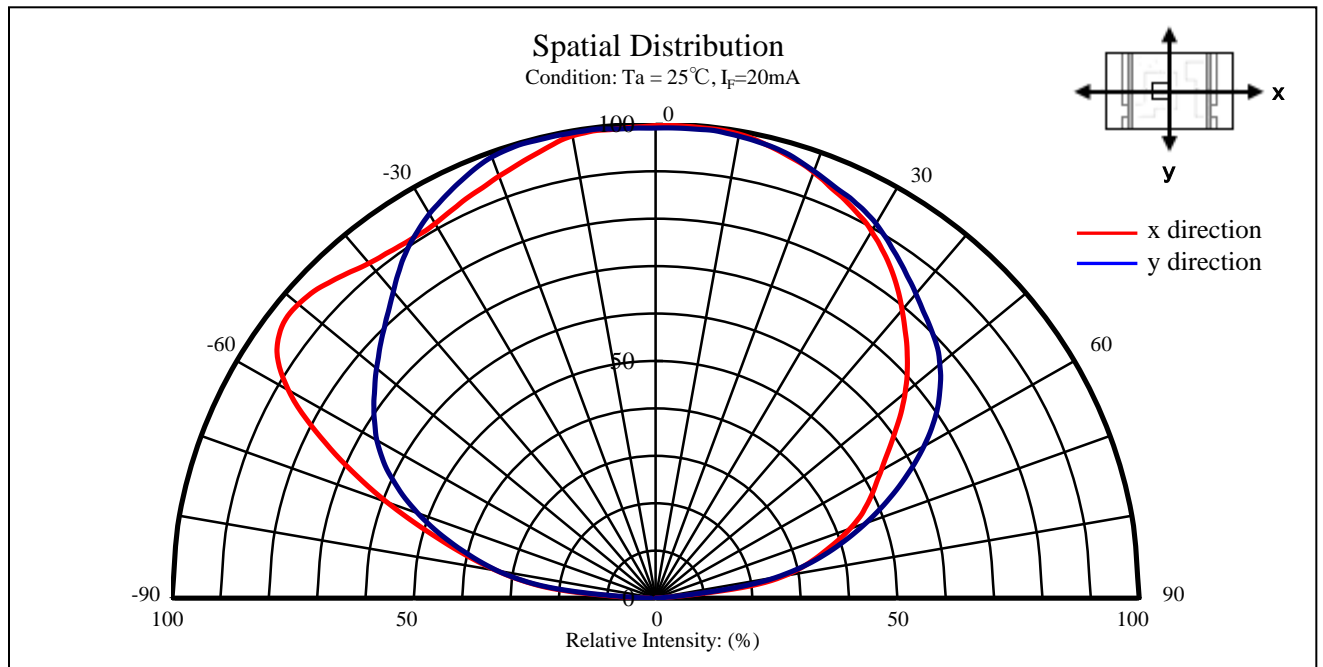
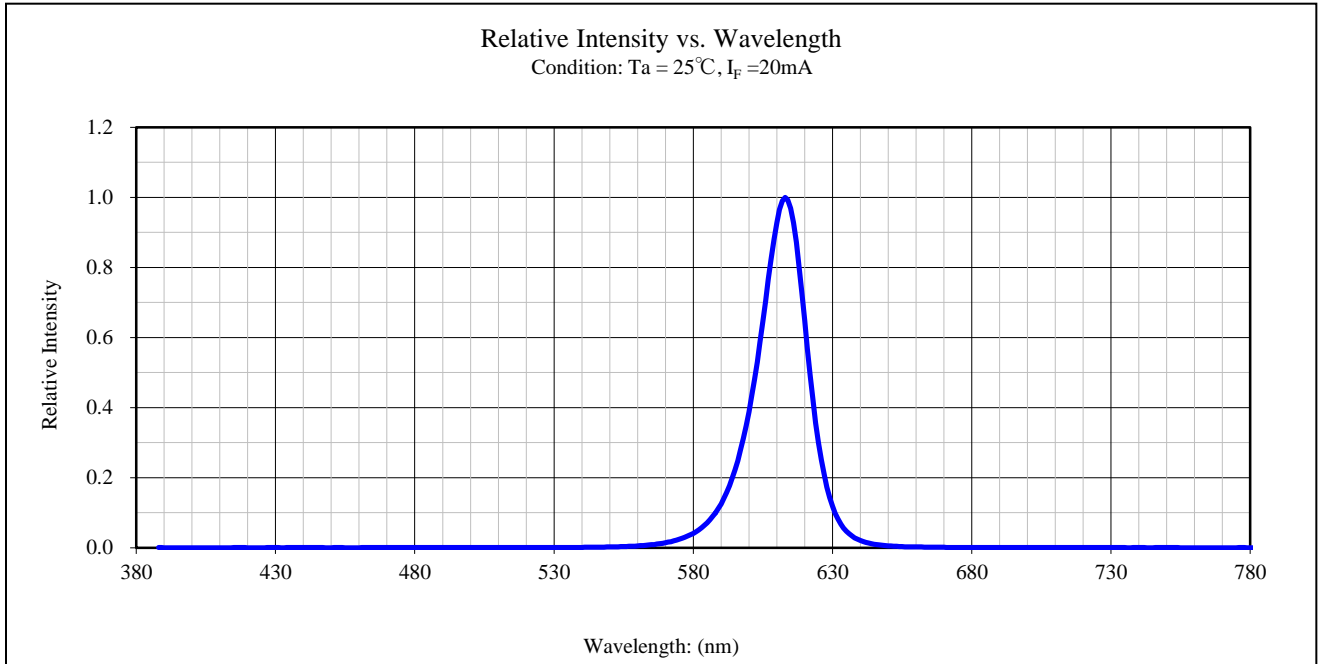

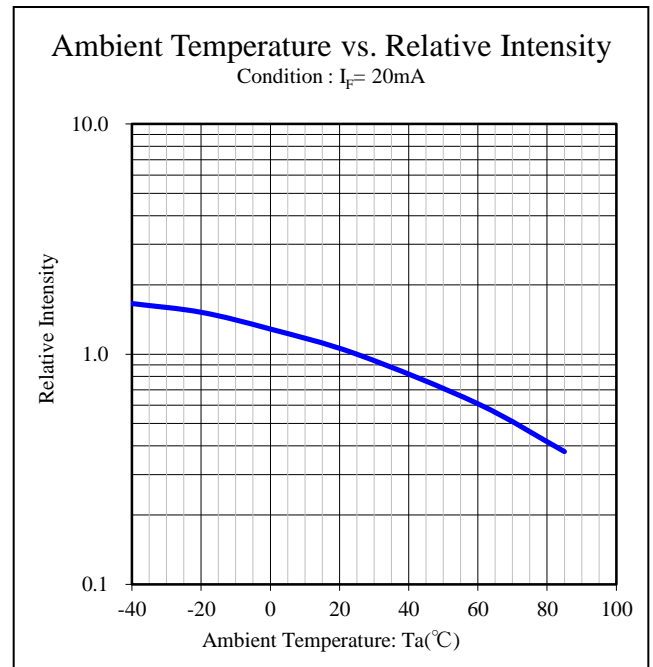
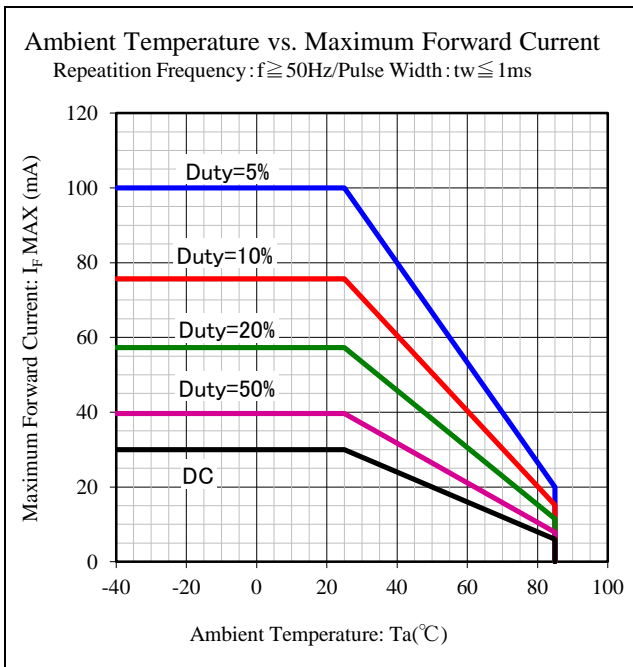
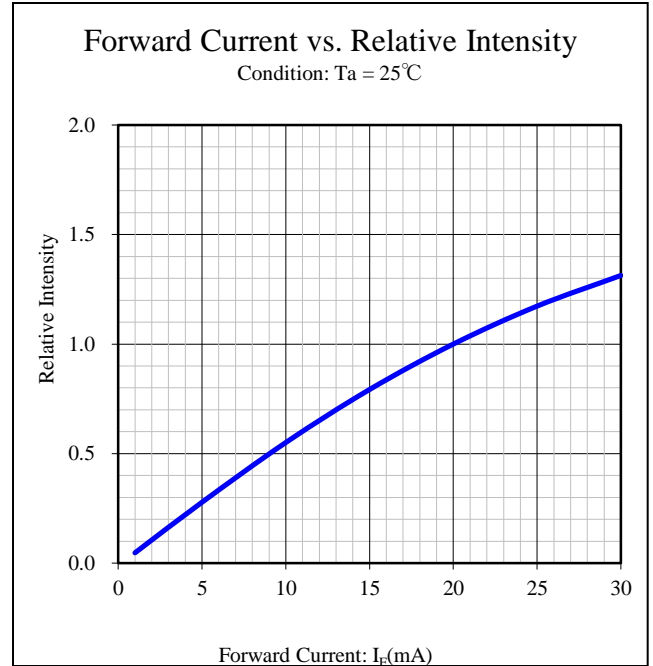
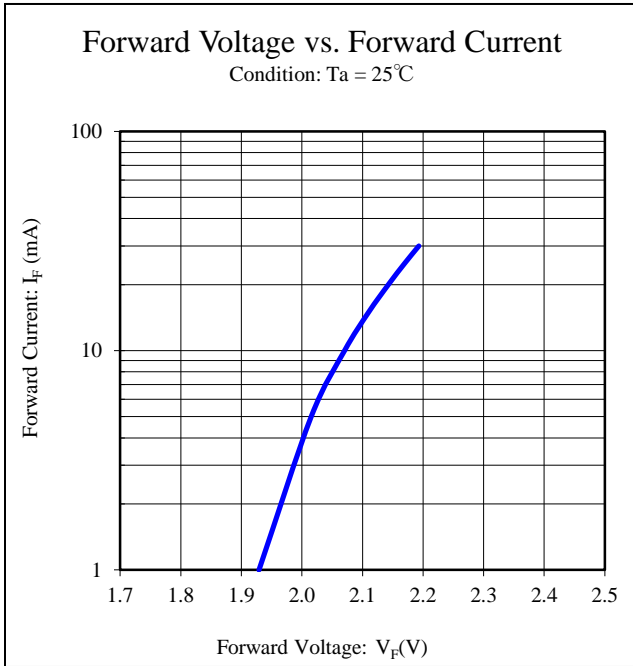

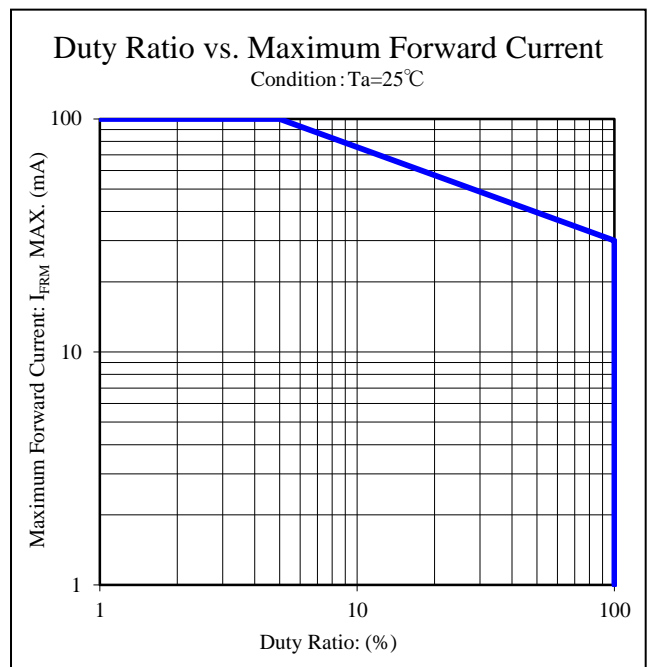
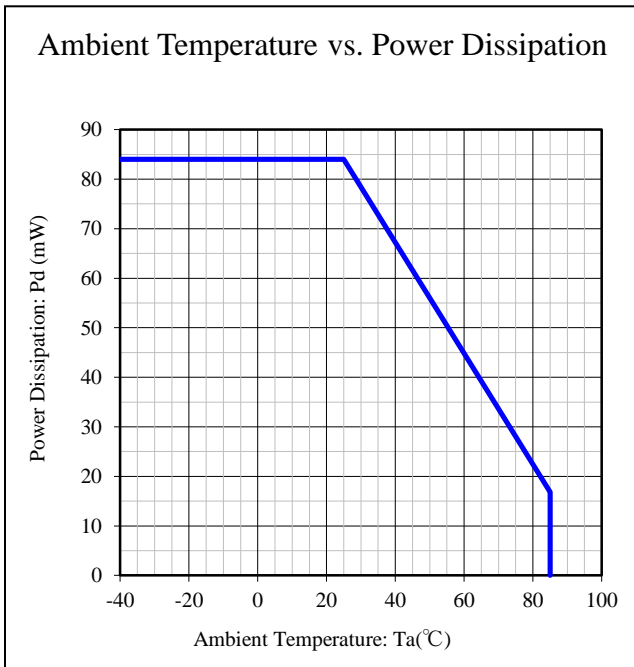
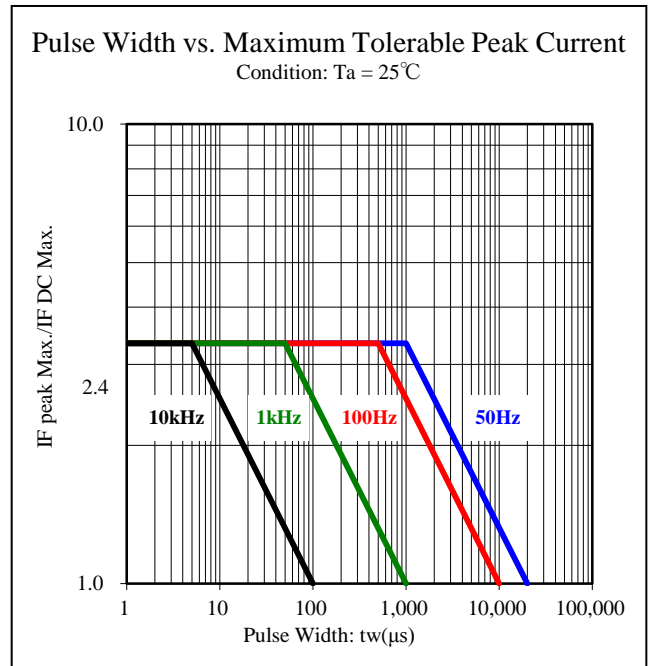
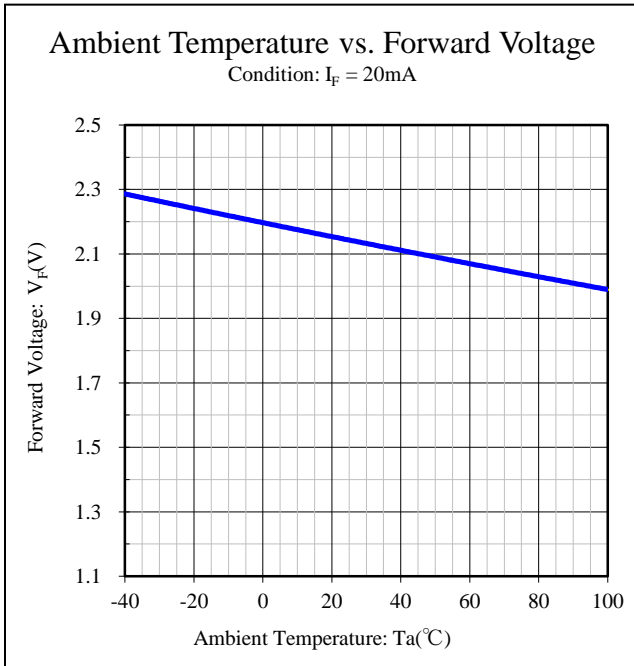

## 【Reflow Soldering】

### 【 Recommended Reflow Soldering Condition 】

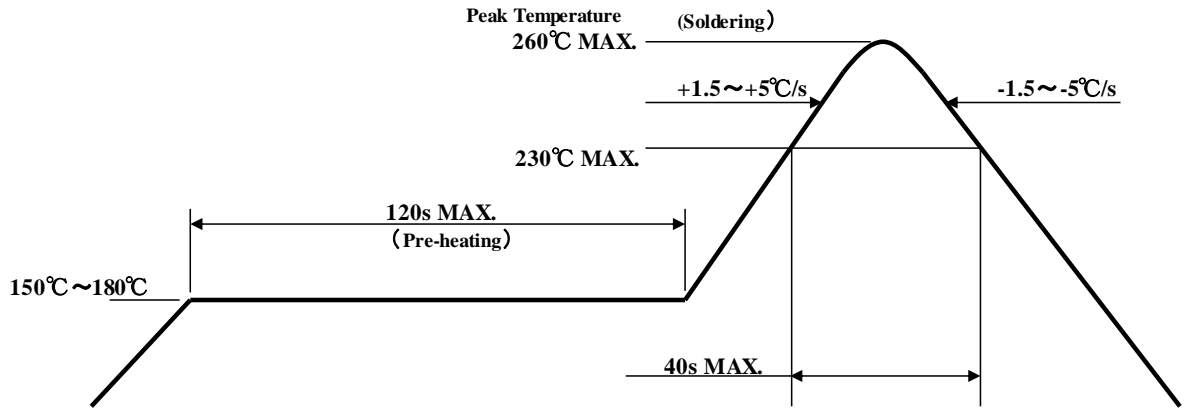

- ① Temperature showed on above profile represents the surface temperature record of resin of LED.
- ② The reflow soldering process should be done up to twice(2 times Max). When second process is performed, interval between first and second process should be as short as possible to prevent absorption of moisture to resin of LED. The second soldering process should not be done until LEDs have returned to room temperature (by nature-cooling) after first soldering process.
- ③ Temp. fluctuation to LED at pre-heat process shall be minimized.

## 【Manual Soldering (Soldering iron)】

Temperature of Iron Tip	350°C MAX.
Soldering Duration, Time	3sec. Max., 1 time

## 【Other Caution】

- ① During the actual soldering, please heat the solder pad, and make sure that soldering iron never touches the products (especially, the resin).
- ② When using adhesive material for tentative fixatives, thermosetting resin or Ultraviolet radiation (UV) setting resin with heat shall be recommended.  
Curing condition temp. : 150 °C MAX. , time : 120s MAX.
- ③ After soldering, avoid any mechanical force or any excess vibration until LEDs have cooled down to room temperature.



## 1. Cleaning

1. Special care shall be taken when applying the chemicals listed below for cleaning because certain chemicals may damage the surface of lens or care and cause discoloration.

Chemical	Adaptability
Ethyl Alcohol	○
Isopropyl Alcohol	○
Pure Water	○
Trichloroethylene	×
Chloroethene	×
Acetone	×
Thinner	×

- ※ Dipping time is 3minutes MAX. (In normal temp.)
- ※ It can be cleaned on the next page conditions, about pure water.

2. Effect of ultrasonic cleaning on the LED resin body differs depending on such factors as the oscillator output, size of P.C.B. and LED mounting method. So the use of ultrasonic cleaning is strongly recommended after confirming that there is no problem.
3. When using Freon equivalent solvent, discoloration on the LED surface may be caused by one of the first confirming that there is no problem.
  - ※ Freon substitute detergent
    - Clean through 750H
    - Pine alpha ST-100S
4. In the case of water-washing , ensure to use pure water (not city water) and , immediately after the washing is over, apply forced drying to remove all the moisture from the LED.

## 【Other Precautions】

1. The products are designed to achieve higher performance reliability, however, they can be influenced by usage conditions.
2. Absolute maximum ratings are set to prevent LED products from failing due to excess stress (temperature, current, voltage, etc.). These ratings must never be overrun even for a moment.
3. To achieve the highest performance reliability, it is necessary to take into account, factors such as forward voltage adjusted to the usage temperature condition, derating of the power consumption, and other variable factors.
4. Please insert Straight Protective Resistors into the circuit in order to stabilize LED operation and to prevent the device from igniting due to excess current.
5. Please check the actual performance in the assembly because the Specification Sheets are described for LED device only.
6. Please refrain from looking directly at the light source of LED at high output, as it may harm your vision.
7. The products are designed to operate without failure in recommended usage conditions. However, please take the necessary precautions to prevent fire, injury, and other damages should any malfunction or failure arise.
8. The products are manufactured to be used for ordinary electronic equipment. Please contact our sales staff beforehand when exceptional quality and reliability are required, and the failure or malfunction of the products might directly jeopardize life or health (such as for airplanes, aerospace, transport equipment, medical applications, nuclear reactor control systems and so on)..
9. The formal specification sheets shall be valid only by exchange of documents by both parties.

This product is baked (moisture removal) before packaging, and is shipped in moisture-proof packaging (as shown below) to minimize moisture absorption during transportation and storage. However, with regard to storing the products, Stanley recommends the use of dry-box under the following conditions is recommended. Moisture-proof bag as the packaging is made of anti-static material but packaging box is not.

## 【Recommended Storage Condition / Products Warranty Period】

Temperature	+5~30°C
Humidity	Under 70%

In the case of the package unopened , 6 months under 【 Recommended Storage Condition 】.  
Please avoid rapid transition from low temp. condition to high temp. condition and storage in corroding and dusty environment.

## 【Time elapsed after Package Opening】

The package should not be opened until immediately prior to its use, and please keep the time frame between package opening and soldering which is **【maximum 72h】**.  
If the device needs to be soldered twice, both soldering operations must be completed within the 72h.

If any components should remain unused, please reseal the package and store them under the conditions described in the 【 Recommended Storage Condition 】 above.

This product must be required to perform baking process (moisture removal) for **at 10~12h( MIN.), at 60 +/- 5 degrees Celsius** if following conditions apply.

1. In the case of silica gel (blue) which indicates the moisture level within the package, changes or loses its blue color.
2. In the case of time passes for 72h after the package is opened once.

Baking process should be performed after LED having been taken out of the package.

Baking may be performed in the tape-reel form , however if it is performed with the reel stacked over one another, it may cause deformation of the reels and taping materials and later obstruct mounting. Please handle only once it has returned to room temperature. Provided that, baking process shall be 2 times MAX.

**【Moisture-proof Packaging Specification】**

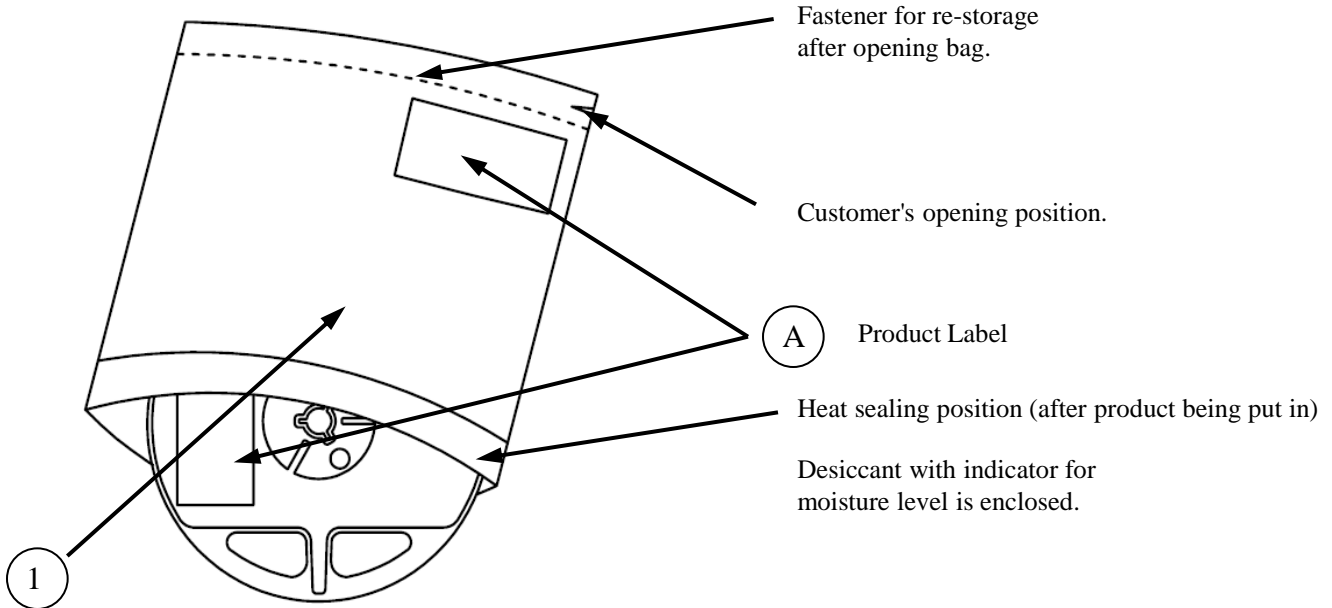

NO.	PART NAME	MATERIAL	REMARKS
①	Moisture-proof bag with Aluminum layer	PET+Al+PE	with ESD protection

**【Flow Chart-package Opening to Mounting】**

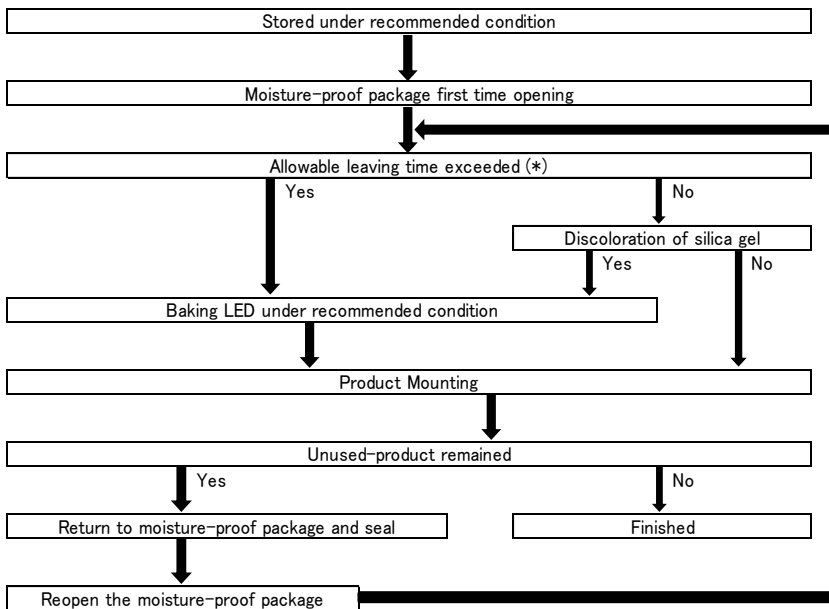

Allowable leaving time means the maximum allowable leaving time after opening package, which depends on each LED type.

The allowable leaving time should be calculated from the first opening of package to the time when soldering process is finished.

When judging if the allowable leaving time has exceeded or not, please subtract the soldering time. The allowable leaving time after reopening should be calculated from the first opening of package, or from the time when baking process is finished.

## 【 Packing box 】

(RoHS•ELV Compliant)

Box TYPE	Outline dimension L × W × H (mm)	Capacity of the box
Type A	280 × 265 × 45	3 reel
Type B	310 × 235 × 265	15 reel
Type C	440 × 310 × 265	30 reel

The above measure is all the reference value.

Shipping box is selected out of the above table by shipping quantity.

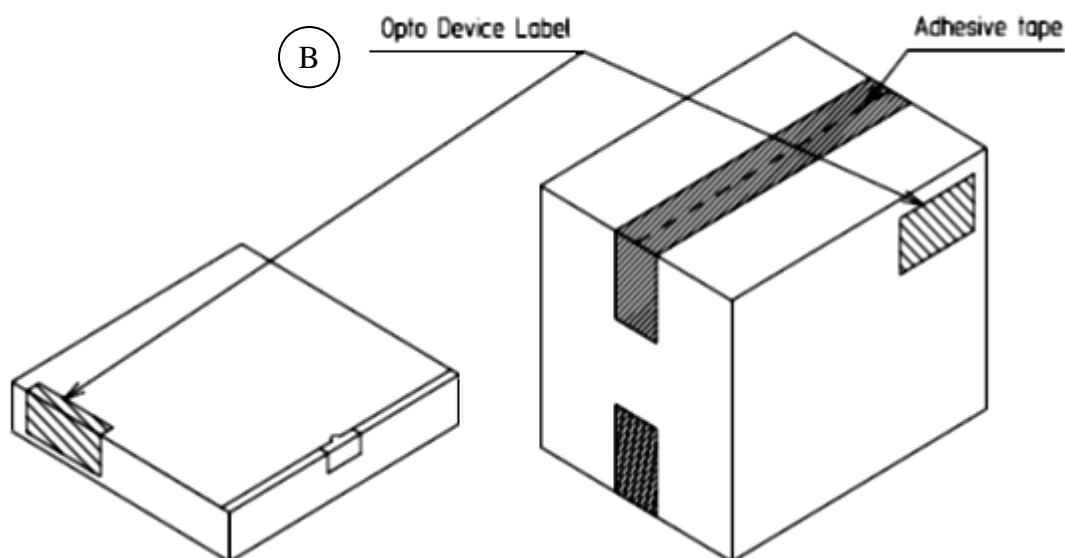

Type A

Material / box : Cardboard C5BF

Type B,C

Material / box : Cardboard K5AF

Partition : Cardboard K5BF

NO.	PART NAME	MATERIAL	REMARKS
②	Packing Box	Corrugated Cardbord	without ESD protection

## 【Label Specification】

( acc.to JIS-X0503(Code-39))

### A Product Label

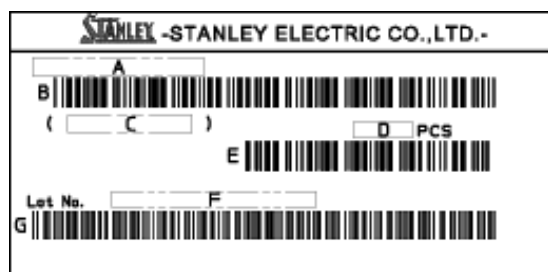

- A. Parts number
- B. Bar-code for parts number
- C. Parts code (In-house identification code for each parts number)
- D. Packed parts quantity
- E. Bar-Code for packed parts quantity
- F. Lot number & Rank  
(refer to Lot Number Notational System for details )
- G. Bar-Code for Lot number & Rank

### B Opto Device Label

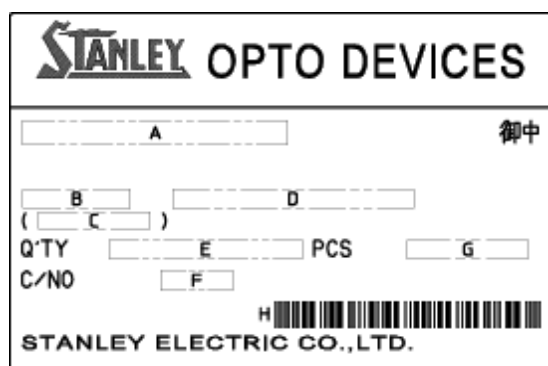

- A. Customer Name
- B. Parts Type
- C. Parts Code
- D. Parts Number
- E. Packed Parts Quantity
- F. Carton Number
- G. Shipping Date
- H. Bar-Code for In-house identification Number

<Remark> Bar-code font : acc.to Code-39(JIX0503)

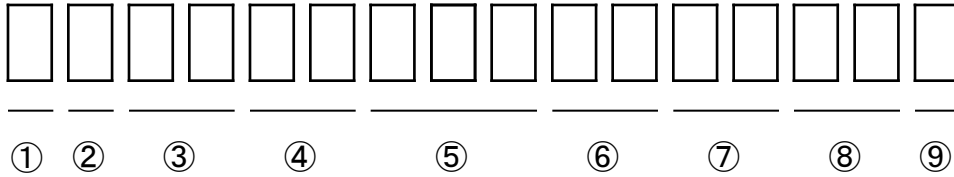

- ① - 1digit : Production Location (Mark identify alphabet)
- ② - 1digit : Production Year (Last digit of production Year 2009→9,2010→0,2011→1,···)
- ③ - 2digits : Production Month (Jan. to Sep. ,should be 01,02,03,·····)
- ④ - 2digits : Production Date
- ⑤ - 3digits : Serial Number
- ⑥ - 2digits : Tape and Reel following Number
- ⑦ - 2digits : Luminous Intensity Rank.  
(If luminous intensity rank is 1 digit, "-" shall be dashed on the place for the second digit.  
If there is no identified intensity rank, "- -" is used to indicate.)
- ⑧ - 2digits : Color Rank  
(If color rank is 1 digit, "-" shall be dashed on the place for the second digit.  
If there is no identified intensity rank, "- -" is used to indicate.)
- ⑨ - 1digit : Option Rank (Stanley normally print "-" to indicate)

# Taping and Reel Specifications

FKA1112H-TR

(acc.to ; JIS-C0806)

## 1. Appearance

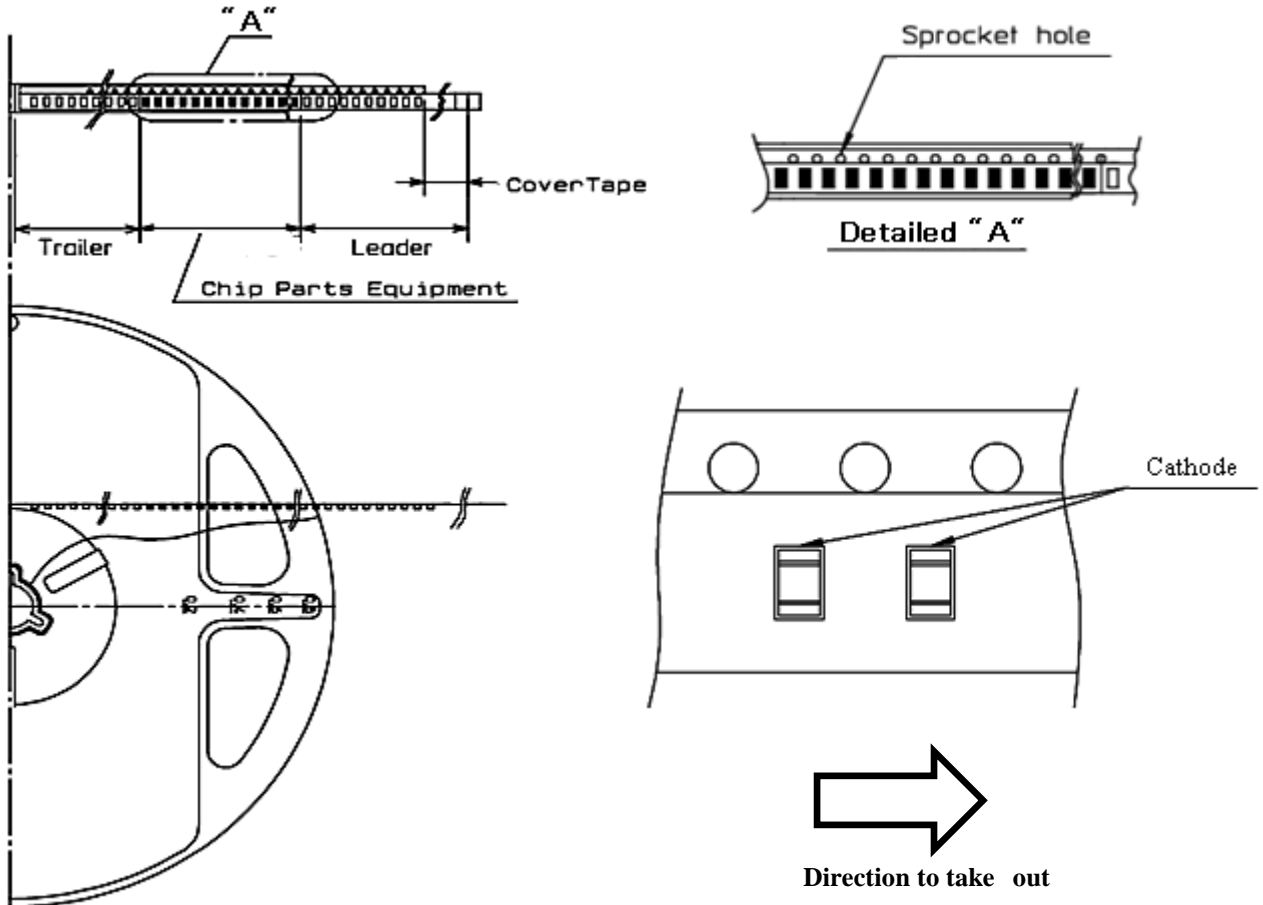

### Note

"-TR" means Cathode Side of LEDs should be placed on the sprocket-hole side.

Items		Specifications	Remarks
Leader area	Cover-tape	Cover-tape shall be longer than 200mm without carrier-tape	The end of cover-tape shall be held with adhesive tape.
	Carrier-tape	Empty pocket shall be more than 10 pieces.	Taping & reel orientation is ; please refer to the above figure.
Trailer area		Empty pocket shall be more than 15 pieces.	The end of taping shall be inserted into a slit of the hub.



## Taping and Reel Specifications

FKA1112H-TR

---

### **【Qty. per Reel】**

4, 000parts/reel

### **【Mechanical strength】**

Cover-tape adhesive strength shall be 0.1~1.0N ( An angle between carrier-tape and cover-tape shall be170 deg. )  
Both tapes shall be so sealed that the contained parts will not come out from the tape when it is bent at a radius of 15mm.

### **【Others】**

Reversed-orientation, Up-side down placing, side placing and out of spec. parts mix shall not be held.

No more than 1 connecting empty pockets of taping.

Empty Pocket per reel : 5piece or less.

# Taping and Reel Specifications

FKA1112H-TR

(acc.to ; JIS-C0806)

## 5. Taping Dimensions

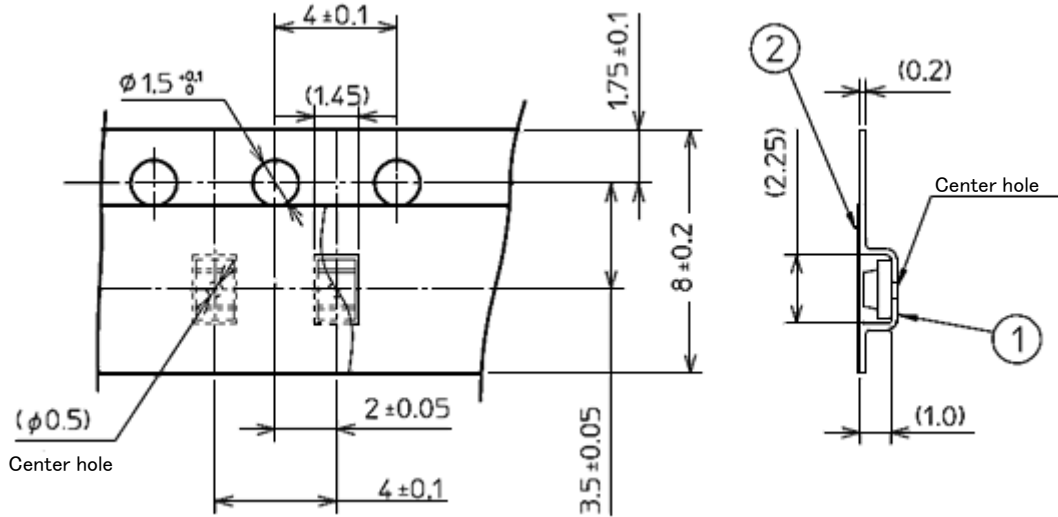

## 6. Reel Dimensions

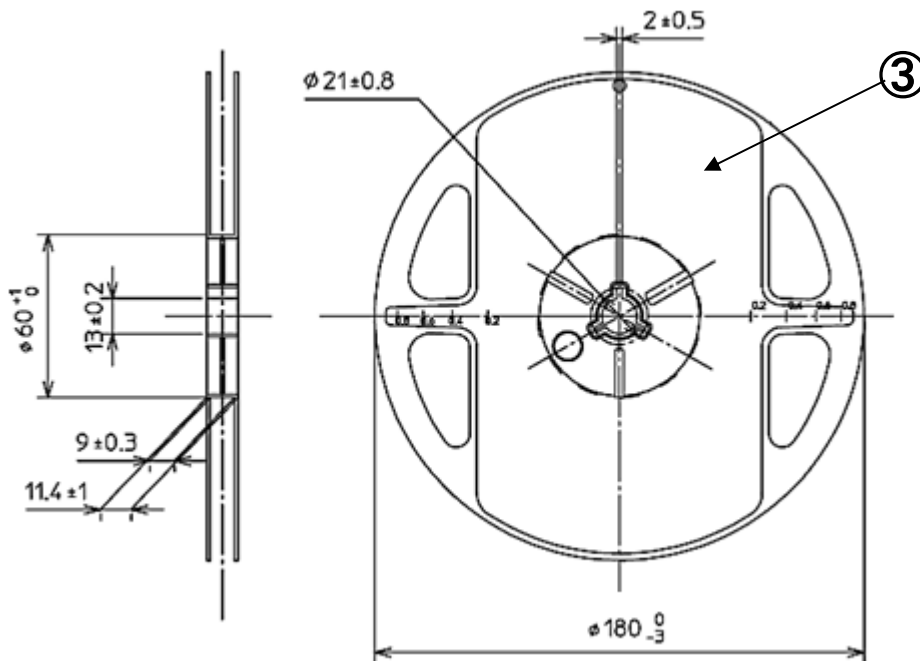

NO.	PART NAME	REMARKS
①	Carrier-tape	Without ESD protection
②	Cover-tape	With ESD protection
③	Carrier-reel	With ESD protection

This product is in compliance with RoHS・ELV.

Prohibition substance and it's criteria value of RoHS・ELV are as follows.

- RoHS instruction ..... Refer to following (1)~(6).
- ELV instruction ..... Refer to following (1)~(4).

	Substance Group Name	Criteria Value
(1)	Lead and its compounds	1,000ppm Max
(2)	Cadmium and its compounds	100ppm Max
(3)	Mercury and its compounds	1,000ppm Max
(4)	Hexavalent chromium	1,000ppm Max
(5)	PBB	1,000ppm Max
(6)	PBDE	1,000ppm Max

# Reliability Testing Result

**FKA1112H-TR**

Test Item	Standard	Test Condition	Duration	Failure
Operating Life	EIAJ ED-4701 /100(101)	Ta = 25°C, I <sub>F</sub> = 30mA	1,000h	0 / 25
High Temperature Storage Life	EIAJ ED-4701 /200(201)	Ta = 100°C	1,000h	0 / 25
Low Temperature Storage Life	EIAJ ED-4701 /200(202)	Ta = -40°C	1,000h	0 / 25
Wet High Temperature Storage Life	EIAJ ED-4701 /100(101)	Ta=60°C±2°C, Rh=90%±5%	1,000h	0 / 25
Thermal Shock	EIAJ ED-4701 /100(105)	Ta= -40°C(30min.) ~ Room temp. (15min.) ~ 100°C(30min.) ~ Room temp. (15min.)	5 cycles	0 / 25
Resistance to Reflow Soldering	EIAJ ED-4701 /300(301)	Preheating : 150~180°C 120s Max. Soldering : 230°C 40s Max. Peak Temperature : 260°C	2times	0 / 25
Vibration, Variable Frequency	EIAJ ED-4701 /400(403)	98.1m/s <sup>2</sup> (10G) 100 ~ 2,000Hz 20min Sweep XYZ direction	2h of each direction	0 / 10

## Failure Criteria

Item	Symbol	Condition	Failure Criteria
Luminous Intensity	I <sub>V</sub>	30mA	Testing Min. Value < Standard Min. Value × 0.5
Forward Voltage	V <sub>F</sub>	30mA	Testing Max. Value ≥ Standard Max. Value × 1.2
Reverse Current	I <sub>R</sub>	V <sub>R</sub> =5V	Testing Max. Value ≥ Standard Max. Value × 2.5
Cosmetic appearance	-	-	Notable, decollation, deformation and cracking

## Special Notice to Customers Using the Products and Technical Information Shown in This Data Sheet

- 1) The technical information shown in the data sheets are limited to the typical characteristics and circuit examples of the referenced products. It does not constitute the warranting of industrial property nor the granting of any license.
- 2) For the purpose of product improvement, the specifications, characteristics and technical data described in the data sheets are subject to change without prior notice. Therefore it is recommended that the most updated specifications be used in your design.
- 3) When using the products described in the data sheets, please adhere to the maximum ratings for operating voltage, heat dissipation characteristics, and other precautions for use. We are not responsible for any damage which may occur if these specifications are exceeded.
- 4) The products that have been described to this catalog are manufactured so that they will be used for the electrical instrument of the benchmark (OA equipment, telecommunications equipment, AV machine, home appliance and measuring instrument).  
The application of aircrafts, space borne application, transportation equipment, medical equipment and nuclear power control equipment, etc. needs a high reliability and safety, and the breakdown and the wrong operation might influence the life or the human body. Please consult us beforehand if you plan to use our product for the usages of aircrafts, space borne application, transportation equipment, medical equipment and nuclear power control equipment, etc. except OA equipment, telecommunications equipment, AV machine, home appliance and measuring instrument.
- 5) In order to export the products or technologies described in this data sheet which are under the “Foreign Exchange and Foreign Trade Control Law,” it is necessary to first obtain an export permit from the Japanese government.
- 6) No part of this data sheet may be reprinted or reproduced without prior written permission from Stanley Electric Co., Ltd.
- 7) The most updated edition of this data sheet can be obtained from the address below:  
<http://www.stanley-components.com/en/>