

Tous droits strictement réservés. Reproduction ou communication a des tiers interdite sous quelque forme que ce soit sans autorisation écrite du propriétaire. Propriété de c FCI. Droits de reproduction FCI.

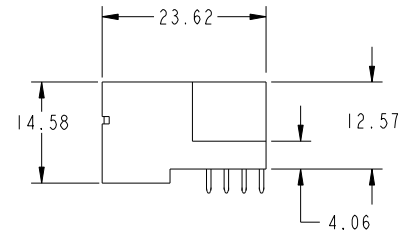

All rights strictly reserved. Reproduction or issue to third parties in any form whatever is not permitted without written authority from the proprietor. Property of FCI. Copyright FCI.

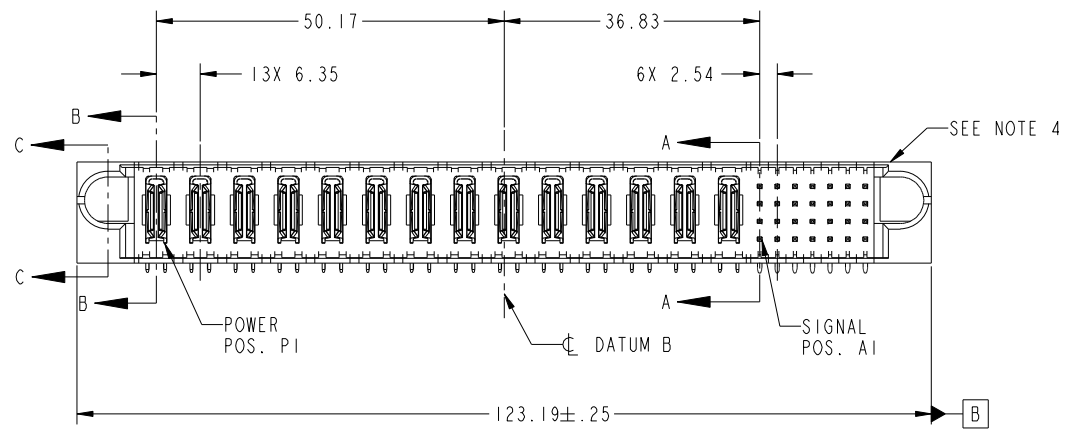
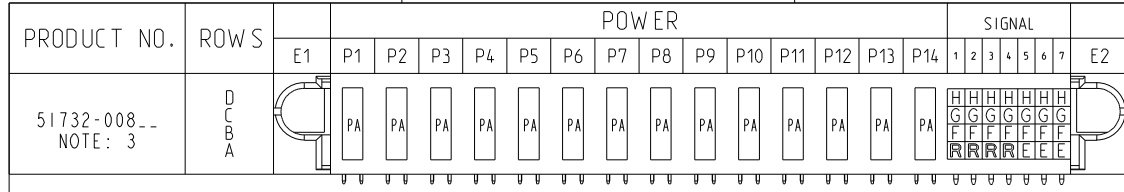

CODE	DIM "M" MATING LENGTH	CONTACT TYPE
E	[5.59]	SIGNAL
F	[5.59]	SIGNAL
G	[5.59]	SIGNAL
H	[5.59]	SIGNAL
R	[6.86]	SIGNAL
PA	[N/A]	POWER

mat'l code				SEE NOTE		tolerances unless otherwise specified		CUSTOMER	
ltr	ecn no.	dr	date	linear	0.X ± 0.5	COPY		projection	
A	V12166	JRW	08/27/01		0.XX ± 0.25	MIM		title	
B	V21294	TAB	09/11/02		0.XXX ± 0.10	1:1		14P + 28S RIGHT ANGLE STB HEADER	
C	DG05-0240	GuoJM	07/25/05	angles	0° ± 2°	scale		product family	
D	DG05-0435	SW	11/03/05	dr	T. BRUNGARD 09/10/02	A		PwrBlade	
E	DG07-0498	JW	09/15/08	engr	M. MOSTOLLER 09/10/02	A		code	
				chr	M. MOSTOLLER 09/10/02			size	
				appd	M. MOSTOLLER 09/10/02			dwg no	
sheet index				revision sheet		E E E E		A	
				1 2 3 4				51732-008	
								213	
								sheet 1 of 4	

www.fciconnect.com  
**14P + 28S**  
**RIGHT ANGLE STB HEADER**  
 product family PwrBlade code 213  
 size A dwg no 51732-008 sheet 1 of 4  
 cage code 22526

Tous droits strictement reserves. Reproduction ou communication a des tiers interdite sous quelque forme que ce soit sans autorisation écrite du propriétaire. Propriete de c FCI. Droits de reproduction FCI.



All rights strictly reserved. Reproduction or issue to third parties in any form whatever is not permitted without written authority from the proprietor. Property of FCI. Copyright FCI.

PRODUCT NUMBER  
51732-008\_-  
NOTE: 3

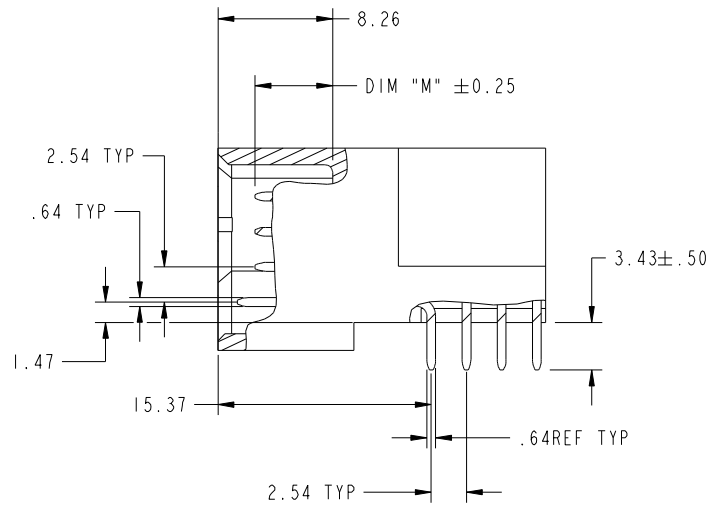

BROKEN-OUT SECTION A-A  
SCALE 2:1

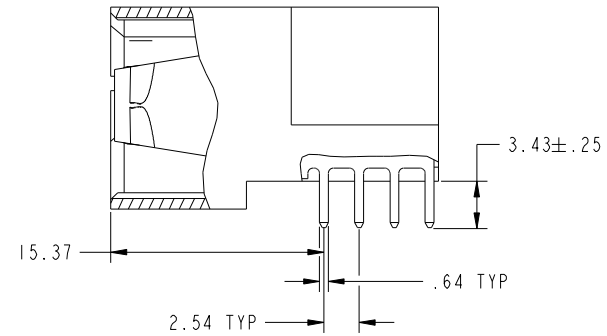

BROKEN-OUT SECTION B-B  
SCALE 2:1

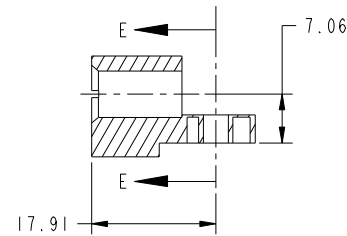

SECTION C-C

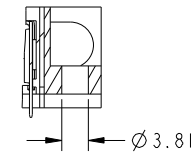

PARTIAL SECTION E-E

mat'l code		SEE NOTE		tolerances unless otherwise specified		CUSTOMER		FCI		www.fciconnect.com	
ltr	ecn no.	dr	date	linear	0.X ±0.5	COPY		title			
E					0.XX ±0.25	projection		14P + 28S			
				angles	0.XXX ±0.10			RIGHT ANGLE STB HEADER			
				dr	0° ±2°			product family		PwrBlade	code
				enrg	T. BRUNGARD 09/10/02			size		dwg no	213
				chr	M. MOSTOLLER 09/10/02	scale		A		51732-008	sheet
				appd	M. MOSTOLLER 09/10/02	1:1					2
sheet index		revision sheet									

Pro/E

cage code 22526

Tous droits strictement reserves. Reproduction ou communication a des tiers interdite sous quelque forme que ce soit sans autorisation écrite du propriétaire. Propriete de c FCI. Droits de reproduction FCI.



All rights strictly reserved. Reproduction or issue to third parties in any form whatever is not permitted without written authority from the proprietor. Property of FCI. Copyright FCI.

PRODUCT NUMBER  
51732-008\_-  
NOTE: 3

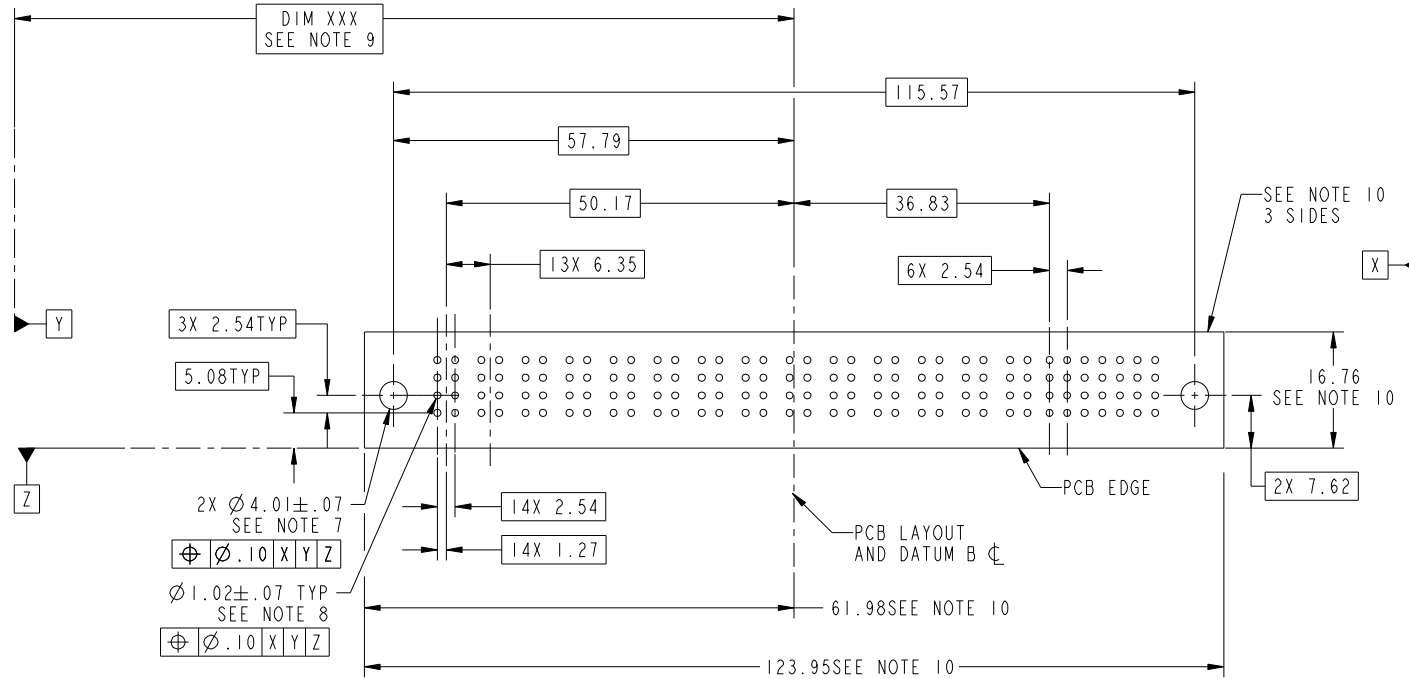

RECOMMENDED PCB LAYOUT

mat'l code		SEE NOTE		tolerances unless otherwise specified		CUSTOMER		www.fciconnect.com	
ltr	ecn no.	dr	date	linear	0.X ± 0.5	COPY		title	
E					0.XX ± 0.25	projection		14P + 28S RIGHT ANGLE STB HEADER	
				angles	0.XXX ± 0.10			product family PwrBlade code 213	
		dr	T. BRUNGARD	09/10/02	0° ± 2°	MIM		size dwg no 51732-008 sheet 3	
		enr	M. MOSTOLLER	09/10/02		scale		A	
		chr	M. MOSTOLLER	09/10/02		1:1			
		appd	M. MOSTOLLER	09/10/02					
sheet index	revision sheet								

cage code 22526

Pro/E

Tous droits strictement reserves. Reproduction ou communication a des tiers interdite sous quelque forme que ce soit sans autorisation écrite du propriétaire. Propriete de c FCI. Droits de reproduction FCI.



All rights strictly reserved. Reproduction or issue to third parties in any form whatever is not permitted without written authority from the proprietor. Property of FCI. Copyright FCI.

PRODUCT NUMBER  
51732-008\_-  
NOTE: 3

NOTES:

1. DIMENSIONS AND TOLERANCES ARE IN ACCORDANCE WITH ASME Y14.5M, 1994 UNLESS OTHERWISE SPECIFIED.

CONNECTOR NOTES:

2. HOUSING MATERIAL: UL 94 V-0 GLASS FILLED HIGH-TEMP THERMOPLASTIC  
POWER CONTACT MATERIAL: COPPER ALLOY  
SIGNAL PIN MATERIAL: COPPER ALLOY

3. PLATING:  
SEE ITEM 1 & 2 IN PRINT 10064183 FOR PLATING SPEC OF 51732-008; &model\_name: SUPP\_51558-001LF PRESPECTIVELY

4. MANUFACTURER'S NAME, P/N, AND DATE CODE TO APPEAR ON THIS SURFACE.

5. PRODUCT SPECIFICATION GS-12-149.  
APPLICATION SPECIFICATION BUS-20-067.

PCB NOTES:

6. ALL HOLE DIAMETERS ARE FINISHED HOLE SIZE.  
7. MOUNTING HOLES, WHERE APPLICABLE, ARE UNPLATED.

8.  $\varnothing 1.151 \pm 0.025$  DRILLED HOLES PLATED WITH 0.008 MIN SnPb OR Sn OVER 0.03 TO 0.08 Cu PLATING TO ACHIEVE  $\varnothing 1.02 \pm 0.07$  HOLE.

9. "DIM XXX" TO BE DETERMINED BY THE CUSTOMER.

10. CONNECTOR KEEP-OUT ZONE.

11. A  $\triangle$  SYMBOL WILL BE NEXT TO ANY DIMENSION, VIEW, OR NOTE WHICH HAS BEEN MODIFIED WITH THE CURRENT DRAWING REVISION.

mat'l code		SEE NOTE		tolerances unless otherwise specified		CUSTOMER		www.fciconnect.com	
ltr	ecn no.	dr	date	linear	0.X ± 0.5	COPY		title	
E					0.XX ± 0.25	projection		14P + 28S	
				angles	0.XXX ± 0.10			RIGHT ANGLE STB HEADER	
				dr	T. BRUNGARD 09/10/02	MIM		product family PwrBlade code	
				enrg	M. MOSTOLLER 09/10/02			size 213	
				chr	M. MOSTOLLER 09/10/02	scale		dwg no 51732-008 sheet	
				appd	M. MOSTOLLER 09/10/02	1:1		4	
sheet index	revision sheet								

cage code 22526

Pro/E