



Features

- Frequency Range 50MHz to 4000MHz
- 6 Bits, 31.5dB Range, 0.5dB Step
- High Linearity, IIP3 >49dBm
- 3V and 5V Logic Compatible
- On-chip Parallel Decoder
- Parallel Programming Interface
- On-chip ESD Protection >500V HBM
- Single Supply, 3V to 5V Operation

Applications

- Transceiver RF and IF Applications
- Cellular, PCS, GSM, UMTS, LTE, WiMax/WiFi
- Wireless Data, Satellite Terminals
- Test Equipment

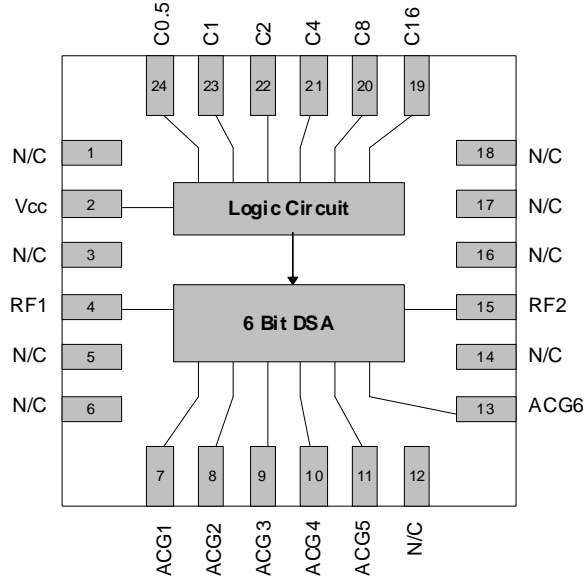

Functional Block Diagram

Product Description

The RFSA2614 is a 6-bit digital step attenuator (DSA) that features high linearity over the entire 31.5dB gain control range with excellent step accuracy in 0.5dB steps. The parallel-controlled RFSA2614 has an on-chip decoder that is both 3V and 5V compatible. It also offers a rugged Class 1B HBM ESD rating via on-chip ESD circuitry.

Ordering Information

RFSA2614SR	7" Reel with 100 pieces
RFSA2614SQ	Sample bag with 25 pieces
RFSA2614TR7	7" Reel with 750 pieces
RFSA2614TR13	13" Reel with 2500 pieces
RFSA2614PCK-410	50MHz to 4000MHz PCBA with 5-piece sample bag

Optimum Technology Matching® Applied

- | | | | |
|--------------------------------------|--------------------------------------|--|------------------------------------|
| <input type="checkbox"/> GaAs HBT | <input type="checkbox"/> SiGe BiCMOS | <input checked="" type="checkbox"/> GaAs pHEMT | <input type="checkbox"/> GaN HEMT |
| <input type="checkbox"/> GaAs MESFET | <input type="checkbox"/> Si BiCMOS | <input type="checkbox"/> Si CMOS | <input type="checkbox"/> BiFET HBT |
| <input type="checkbox"/> InGaP HBT | <input type="checkbox"/> SiGe HBT | <input type="checkbox"/> Si BJT | |

RF MICRO DEVICES®, RFMD®, Optimum Technology Matching®, Enabling Wireless Connectivity™, PowerStar®, POLARIS™ TOTAL RADIO™ and UltimateBlue™ are trademarks of RFMD, LLC. BLUETOOTH is a trademark owned by Bluetooth SIG, Inc., U.S.A. and licensed for use by RFMD. All other trade names, trademarks and registered trademarks are the property of their respective owners. ©2012, RF Micro Devices, Inc.

Absolute Maximum Ratings

Parameter	Rating	Unit
Supply Voltage	5.5	V _{DC}
DC Supply Current	15	mA
DC Power Dissipation	83	mW
Max RF Input Power	27	dBm
Operating Temperature (T _{CASE})	-40 to +85	°C
Storage Temperature	-40 to +150	°C
Junction Temperature	150	°C
ESD Rating (HBM)	Class 1B	
Moisture Sensitivity Level	MSL1	



Caution! ESD sensitive device.

Exceeding any one or a combination of the Absolute Maximum Rating conditions may cause permanent damage to the device. Extended application of Absolute Maximum Rating conditions to the device may reduce device reliability. Specified typical performance or functional operation of the device under Absolute Maximum Rating conditions is not implied.

The information in this publication is believed to be accurate and reliable. However, no responsibility is assumed by RF Micro Devices, Inc. ("RFMD") for its use, nor for any infringement of patents, or other rights of third parties, resulting from its use. No license is granted by implication or otherwise under any patent or patent rights of RFMD. RFMD reserves the right to change component circuitry, recommended application circuitry and specifications at any time without prior notice.



RFMD Green: RoHS compliant per EU Directive 2002/95/EC, halogen free per IEC 61249-2-21, < 1000ppm each of antimony trioxide in polymeric materials and red phosphorus as a flame retardant, and <2% antimony in solder.

Parameter	Specification			Unit	Condition
	Min.	Typ.	Max.		
Frequency Range	50		4000	MHz	
Insertion Loss		1.6	1.9	dB	500MHz, 0dB attenuation
		1.7		dB	850MHz, 0dB attenuation
		2.1		dB	2140MHz, 0dB attenuation
		2.2	2.8	dB	2700MHz, 0dB attenuation
		2.8		dB	3800MHz, 0dB attenuation
Gain Control Range		31.5		dB	0.5dB step size
Step Accuracy	±(0.15 + 5.0% attenuation setting)			dB	
IIP3		>49		dBm	700MHz to 2700MHz, states 0 thru 27.5dB
IIP3		>45		dBm	700MHz to 2700MHz, states 28 thru 31.5dB
Input P1dB		>27		dBm	700MHz to 2700MHz, all states
Return Loss		>18		dB	700MHz to 2700MHz, all states
Control Interface		6		bit	Parallel interface
Settling Time		200		ns	t _{RISE} , t _{FALL} (10%/90% RF)
Switching Speed		200		ns	t _{ON} , t _{OFF} (50% CTL to 10%/90% RF)
Supply Voltage (V _{DD})	3.0	5.0	5.25	V	Typical performance based on 5V operation.
Supply Current		3.5		mA	
Control Voltage (V _{CTL})	0		0.8	V	Low
	2.0		V _{DD}	V	High

Notes:

1. V_{DD} = 5V, V_{CTL} = 3V, T = 25 °C
2. Broadband Application Circuit (with ACG capacitors)
3. IIP3 measured with 1MHz spacing, P_{IN} = 4dBm/tone for frequency < 300MHz, P_{IN} = 10dBm/tone for frequency > 300MHz

Typical Broadband Application Circuit Performance
(with ACG capacitors)

Gain versus Frequency, Reference State (0dB)

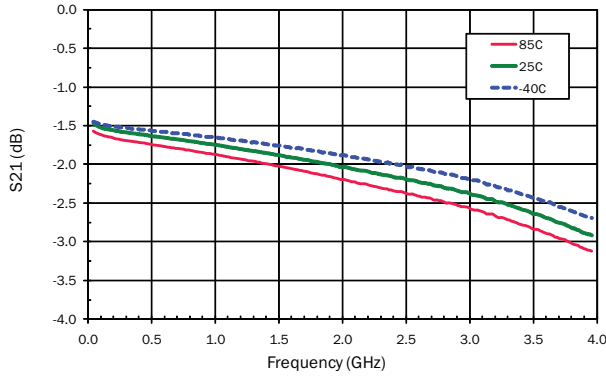

Normalized Attenuation, Major States

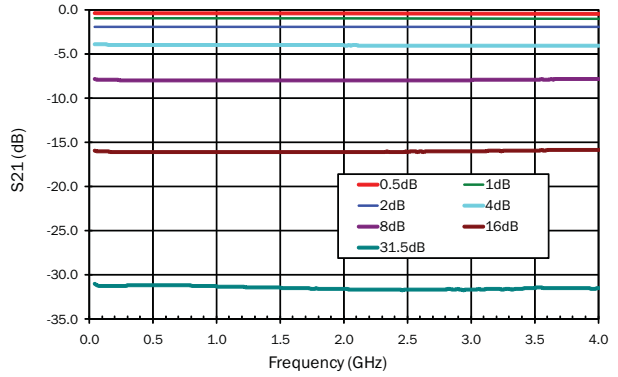

RF1 RL versus Frequency, Major States

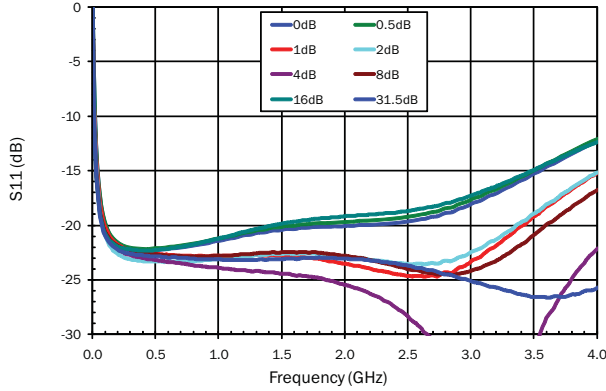

RF2 RL versus Frequency, Major States

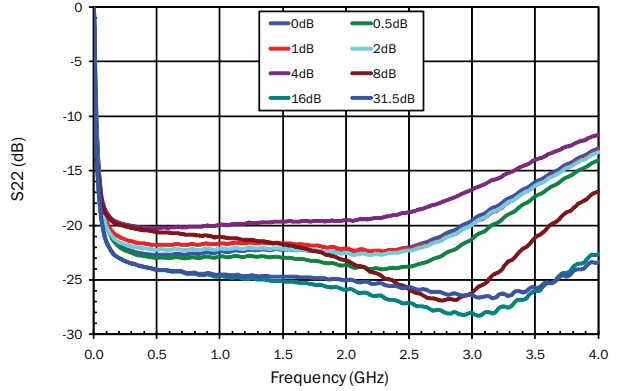

Relative Phase, Major States

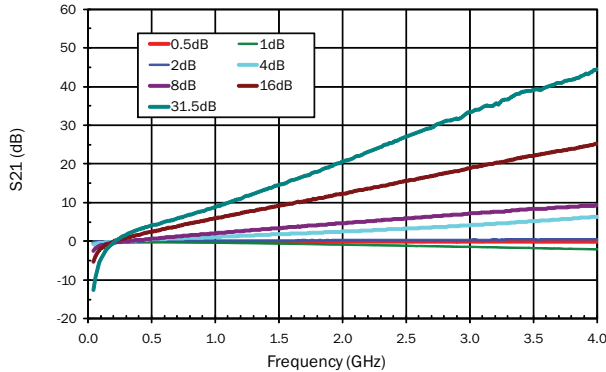

Input IP3 versus Frequency, All States, 25C

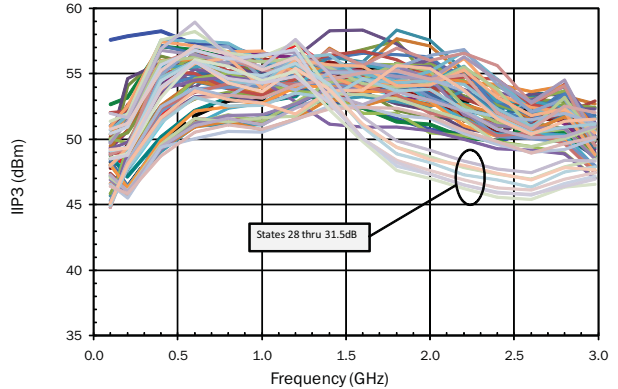

Typical Broadband Application Circuit Performance (with and without ACG capacitors)

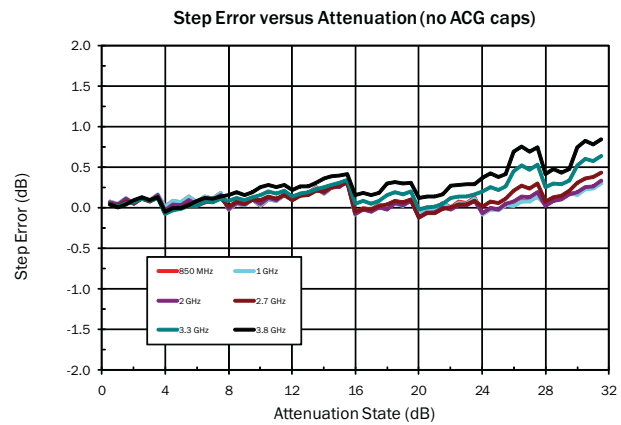
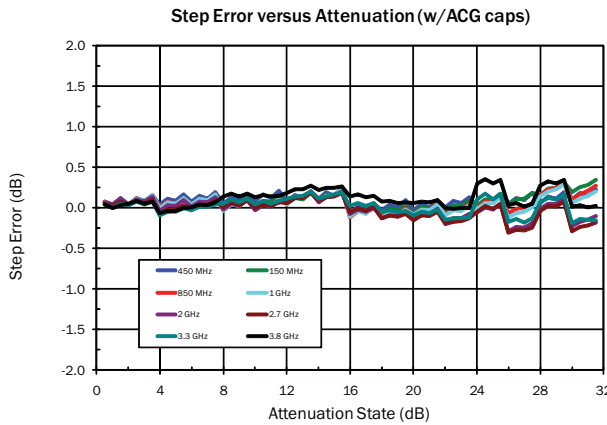
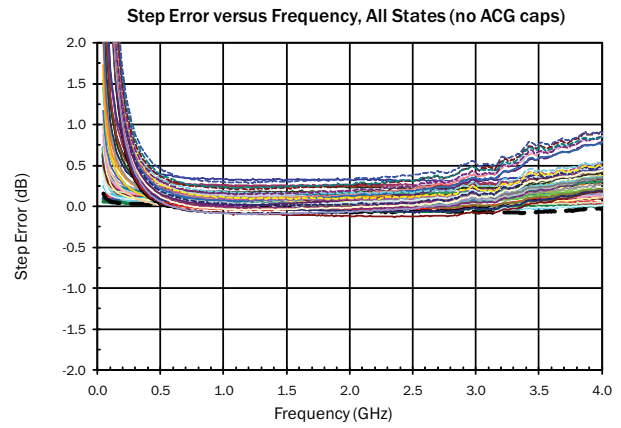
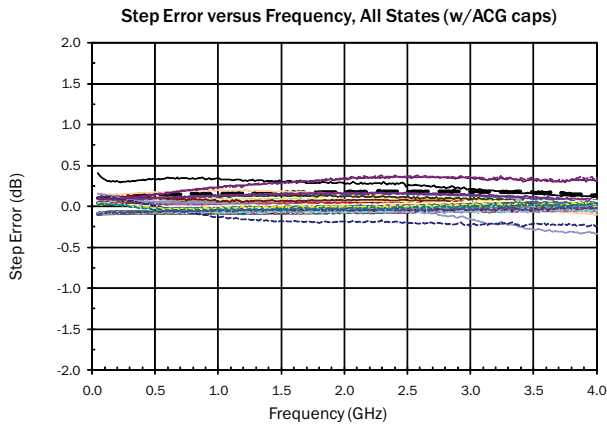
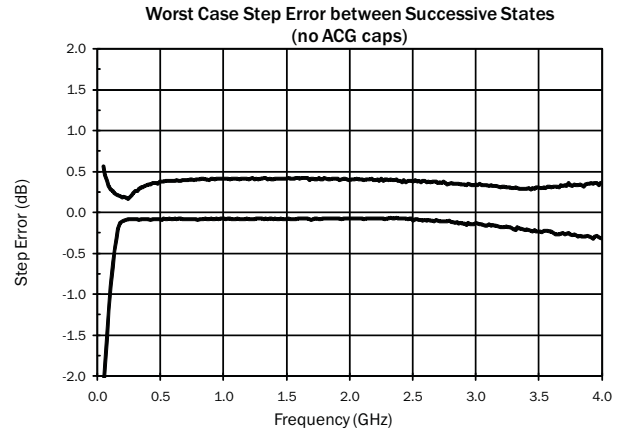
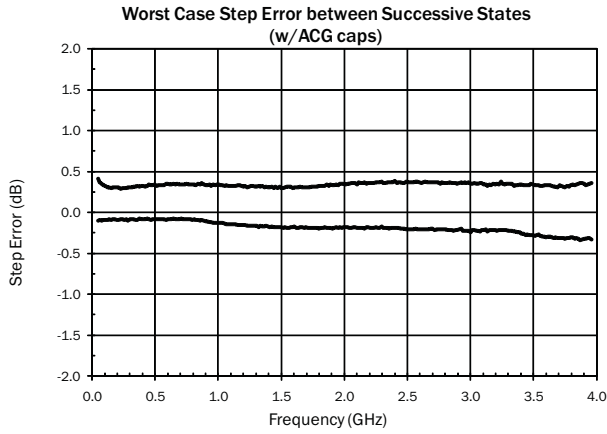

Truth Table

Control Bit						Relative Gain Setting
C16	C8	C4	C2	C1	C0.5	
1	1	1	1	1	1	Max gain
1	1	1	1	1	0	-0.5dB
1	1	1	1	0	1	-1dB
1	1	1	0	1	1	-2dB
1	1	0	1	1	1	-4dB
1	0	1	1	1	1	-8dB
0	1	1	1	1	1	-16dB
0	0	0	0	0	0	-31.5dB

Logic Voltage Levels	
State	Logic
Low	0V to 0.8V
High	2.0V to 5.0V

Pin Names and Descriptions

Pin	Name	Description
1	NC	No internal connection. EVB can be ground or no connect.
2	VDD	Power supply.
3	NC	No internal connection. EVB can be ground or no connect.
4	RF1	RF port. External DC block required.
5	NC	No internal connection. EVB can be ground or no connect.
6	NC	No internal connection. EVB can be ground or no connect.
7	ACG	AC ground connection for operation below 500MHz.
8	ACG	AC ground connection for operation below 500MHz.
9	ACG	AC ground connection for operation below 500MHz.
10	ACG	AC ground connection for operation below 500MHz.
11	ACG	AC ground connection for operation below 500MHz.
12	NC	No internal connection. EVB can be ground or no connect.
13	ACG	AC ground connection for operation below 500MHz.
14	NC	No internal connection. EVB can be ground or no connect.
15	RF2	RF port. External DC block required.
16	NC	No internal connection. EVB can be ground or no connect.
17	NC	No internal connection. EVB can be ground or no connect.
18	NC	No internal connection. EVB can be ground or no connect.
19	D5	16dB control bit.
20	D4	8dB control bit.
21	D3	4dB control bit.
22	D2	2dB control bit.
23	D1	1dB control bit.
24	D0	0.5dB control bit.
EPAD	GND	DC and RF ground. Must be soldered to EVB ground plane over a bed of vias for thermal and RF performance.

Evaluation Board Assembly Drawing

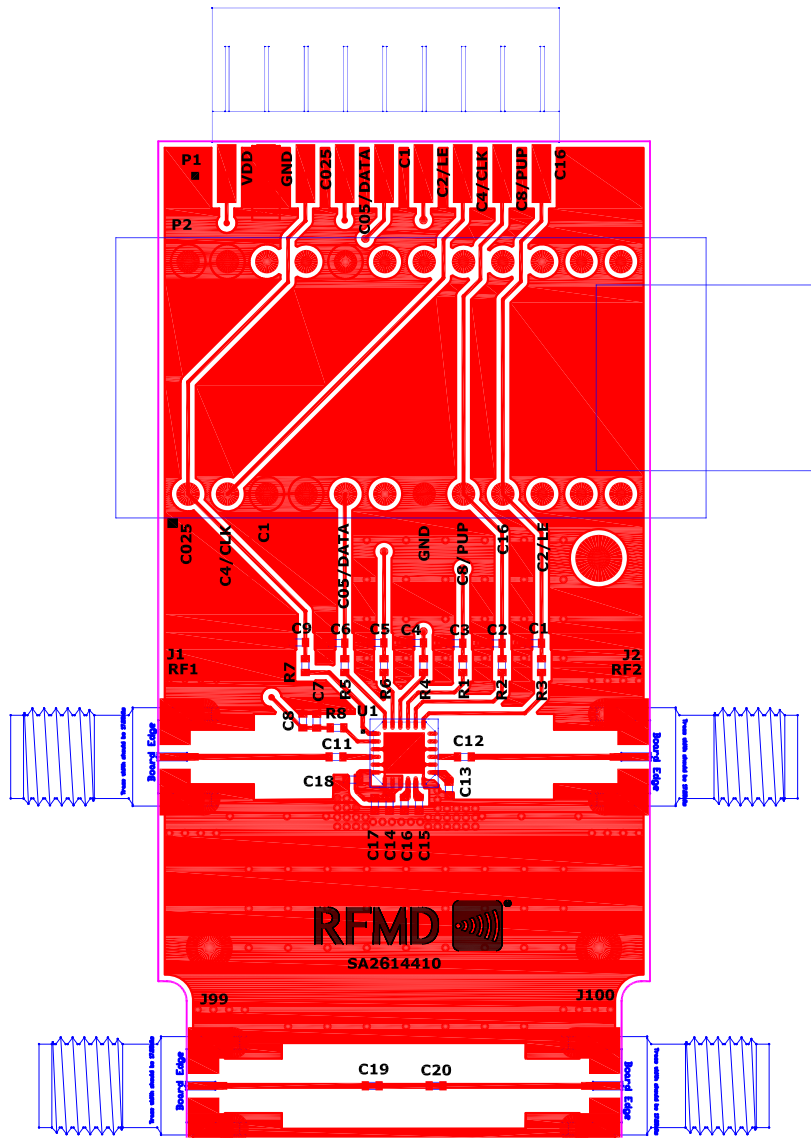

Evaluation Board Schematic (with ACG capacitors)

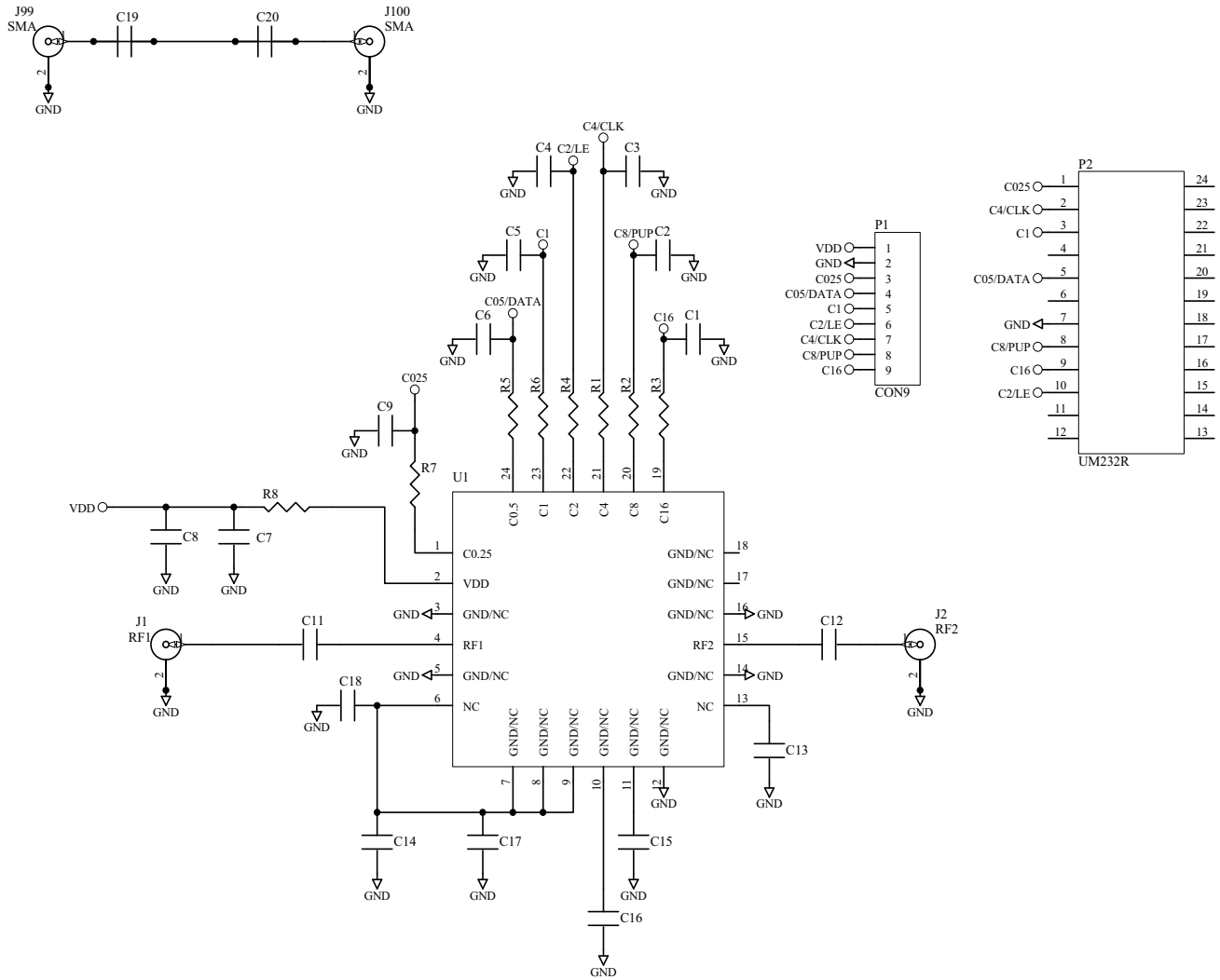

Evaluation Board Bill of Materials

Description	Reference Designator	Manufacturer	Manufacturer's P/N
RFSA2714 Evaluation Board	PCB itself	Dynamic Details (DDI) Toronto	SA2714410(A)
6-Bit SA Parallel 0.5dB QFN 4x4	U1	RFMD	RFSA2614SB
CAP, 680pF, 10%, 50V, X7R, 0402	C13, C15-C17	Murata Electronics N. America	GRM155R71H681KA01E
CAP, 1000pF, 10%, 50V, X7R, 0402	C7	Taiyo Yuden (USA), Inc.	RM UMK105BJ102KV-F
CAP, 470pF, 10%, 50V, X7R, 0402	C11-C12	Murata Electronics	GRM155R71H471KA01E
RES, 0Ω, 0402	R1-R6, R8	Kamaya, Inc	RMC1/16SJPTH
CONN, SMA, END LNCH, UNIV, HYB MNT, FLT	J1-J2, J99-J100	Molex	SD-73251-4000
CONN, HDR, ST, PLRZD, 9-PIN	P1	ITW Pancon	MPSS100-9-C
CONN, SKT, 24-PIN DIP, .600", T/H	P2	Aries Electronics Inc.	24-6518-10
MOD, USB TO SERIAL UART, SSOP-28	M1 (See Note Below)	Future Technology Devices Int'l	UM232R
DNP	C1-C6, C8-C9, C14, C18-C20, R7	NA	NA

Note: M1 should be mounted into P2 with respect to the Pin 1 alignment of M1 and P2

Package Drawing

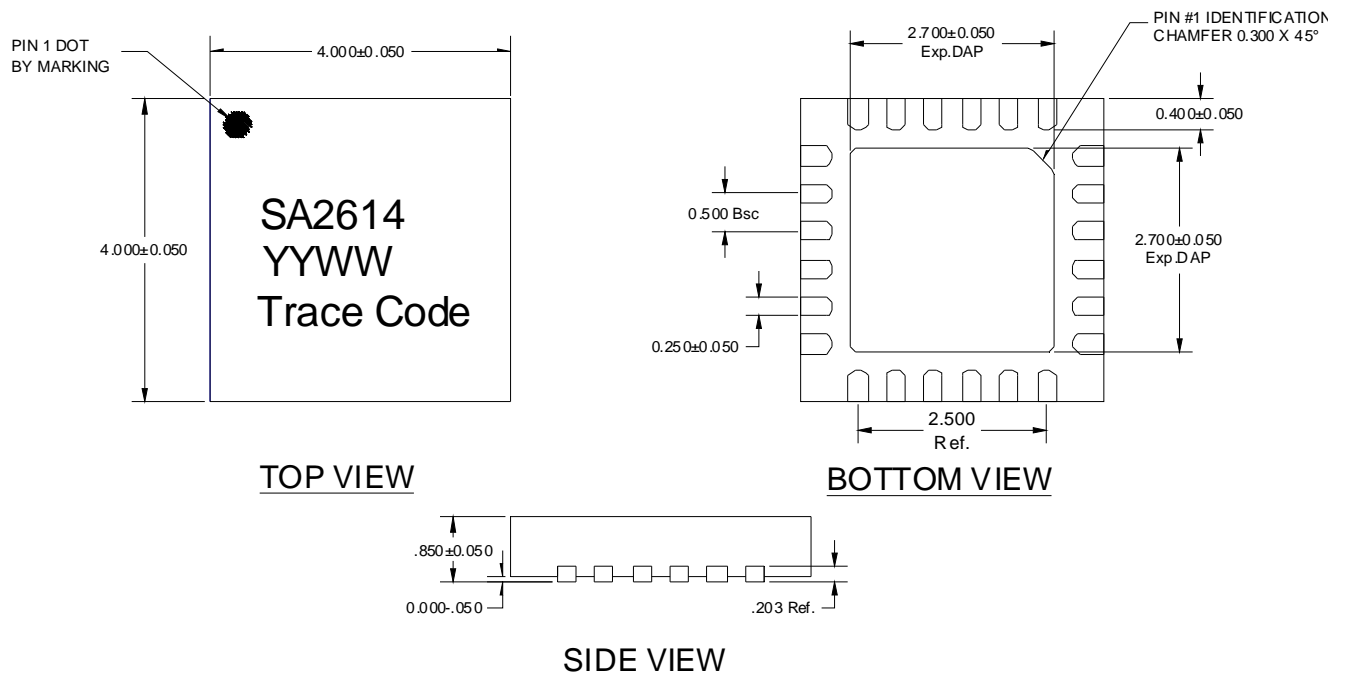

YYWW = Date Code, where YY=year, WW=week

Trace Code to be assigned by assembly SubCon