

Printed-circuit board connector - MSTBA 2,5/ 3-G-5,08-LR - 1809089

Please be informed that the data shown in this PDF Document is generated from our Online Catalog. Please find the complete data in the user's documentation. Our General Terms of Use for Downloads are valid (<http://download.phoenixcontact.com>)

Header, Nominal current: 12 A, Rated voltage (III/2): 320 V, Number of positions: 3, Pitch: 5.08 mm, Color: green, Contact surface: Tin, Assembly: Soldering



Key commercial data

Packing unit	0
Minimum order quantity	1
GTIN	 4 046356 702539
Custom tariff number	85366990
Country of origin	GERMANY

Technical data

Dimensions / positions

Length	12 mm
Height	11.9 mm
Pitch	5.08 mm
Dimension a	10.16 mm
Number of positions	3
Pin dimensions	1 x 1 mm
Hole diameter	1.4 mm

Technical data

Range of articles	MSTBA 2,5/...-G-LR
Insulating material group	IIIa
Rated surge voltage (III/3)	4 kV
Rated surge voltage (III/2)	4 kV
Rated surge voltage (II/2)	4 kV
Rated voltage (III/2)	320 V
Rated voltage (II/2)	400 V
Connection in acc. with standard	EN-VDE
Nominal current I _N	12 A
Nominal voltage U _N	250 V
Maximum load current	12 A

Printed-circuit board connector - MSTBA 2,5/ 3-G-5,08-LR - 1809089

Technical data

Technical data

Insulating material	PBT
Inflammability class according to UL 94	V0
Color	green

Classifications

eclass

eCl@ss 5.1	27141190
eCl@ss 6.0	27260704

Accessories

Accessories

Assembly

Accessories - MSTB-BL - 1755477



Keying cap, for forming sections, plugs onto header pin, green insulating material

Marking

Marker cards - SK 5,08/3,8:FORTL.ZAHLEN - 0804293



Marker cards, Card, white, Labeled, Horizontal: Consecutive numbers 1 - 10, 11 - 20, etc. up to 91 - (99)100, Mounting type: Adhesive, For terminal block width: 5.08 mm

Plug/Adapter

Keying star - CR-MSTB - 1734401



Coding section, inserted into the recess in the header or the inverted plug, red insulating material

Drawings

Printed-circuit board connector - MSTBA 2,5/ 3-G-5,08- LR - 1809089

Drilling diagram

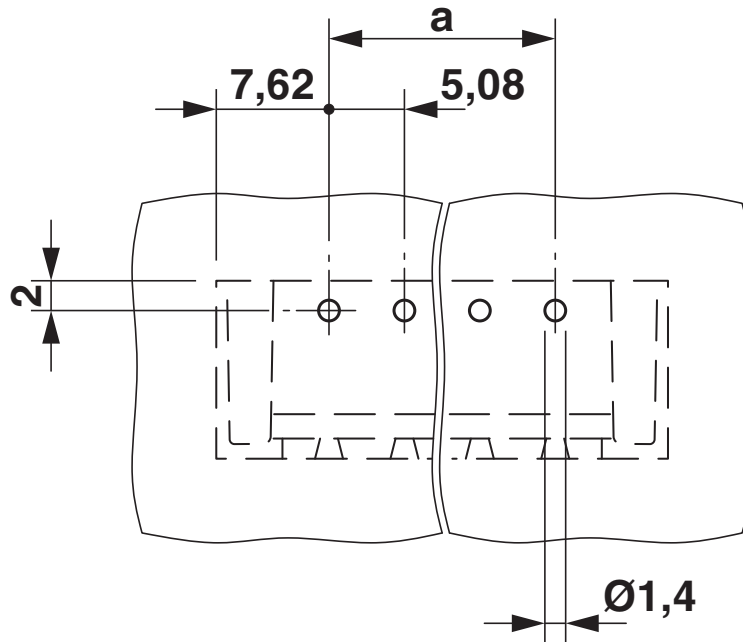

Printed-circuit board connector - MSTBA 2,5/ 3-G-5,08- LR - 1809089

Dimensioned drawing

