

# PSE Technology Corporation

## SPECIFICATION FOR APPROVAL

CUSTOMER	
NOMINAL FREQUENCY	<b>8.000000 MHz</b>
PRODUCT TYPE	<b>TYPE GB 49S QUARTZ CRYSTAL</b>
PART NUMBER	<b>GB0800004</b>
CUSTOMER P/N	
ISSUE DATE	<b>June 13, 2016</b>
VERSION	<b>B</b>

APPROVED	PREPARED	QA
<i>Brenda</i>	<i>Nikki Lu</i>	<i>Song Yang</i>
APPROVED BY CUSTOMER		
Please return one copy with approval to PSE-TW		

### PSE Technology Corporation

No.2, Tzu-Chiang 5th Rd., Chung Li Industrial Park,  
 Chung Li City, Taoyuan County, Taiwan (R.O.C.)  
 TEL:886-3-451-8888  
 FAX:886-3-461-3865  
<http://www.saronix-ecera.com.tw/>

\*RoHS Compliant  
 \*HF-Halogen Free  
 \*REACH Compliant

**A Company of PERICOM Semiconductor Corporation**

# TYPE GB 49S QUARTZ CRYSTAL

## **GB0800004**

VER.B 13-JUN-16

### VERSION HISTORY

Version No.	Version Date	Customer Receipt Date	Supplier Receipt Date	Description	Notes
A	Jan. 3, 2012			Initial Release	
B	Jun. 13, 2016			Updated packing	

# TYPE GB 49S QUARTZ CRYSTAL

## GB0800004

VER.B 13-JUN-16

### ELECTRICAL SPECIFICATIONS

Item	Symbol	Specifications	Units	Notes
Nominal Frequency	Fn	8.000000	MHz	
Mode of Oscillation	MO	AT Cut-Fundamental		
Calibration Load Capacitance	CL	30	pF	
Calibration Tolerance	FL	$\pm 30$	ppm	at 25°C $\pm 3^{\circ}\text{C}$
Operating Temperature Range	TR	-10 to +70	°C	
Frequency Stability(Frequency Deviation over the Operating Temperature Range)	F/T	$\pm 30$	ppm	Reference to the Frequency at 25°C
Operating Drive Level		100	$\mu\text{W}$	
Maximum Drive Level		500	$\mu\text{W}$	
Equivalent Series Resistance	ESR	80	$\Omega$	Max.
Shunt Capacitance	C0	5	pF	Max.
Aging at 25°C		$\pm 3$	ppm	Max, 1st year
Storage Temperature		-55 to +125	°C	
Insulation Resistance		500	M $\Omega$	Min

# TYPE GB 49S QUARTZ CRYSTAL

**GB0800004**

VER.B 13-JUN-16

## RELIABILITY SPECIFICATIONS

### MECHANICAL AND ENVIRONMENTAL RATINGS:

- a) FINE LEAK TEST: JESD22-A109 (Condition 1A)
- b) GROSS LEAK TEST: JESD22-A109 (Condition C)
- c) MOISTURE RESISTANCE: JESD22-A113
- d) SHOCK: JESD22-B104 (Condition B)
- e) SOLDERABILITY : (RoHS version): J-STD-002
- f) VIBRATION: JESD22-B103
- g) SOLVENT RESISTANCE: JESD22-B107
- h) RESISTANCE TO SOLDERING HEAT (RoHS version): J-STD-020D Table 5.2 Pb free devices (3 cycles max)

## SUGGESTED IR REFLOW PROFILE

\*As per IPC-JEDEC J-STD-020D

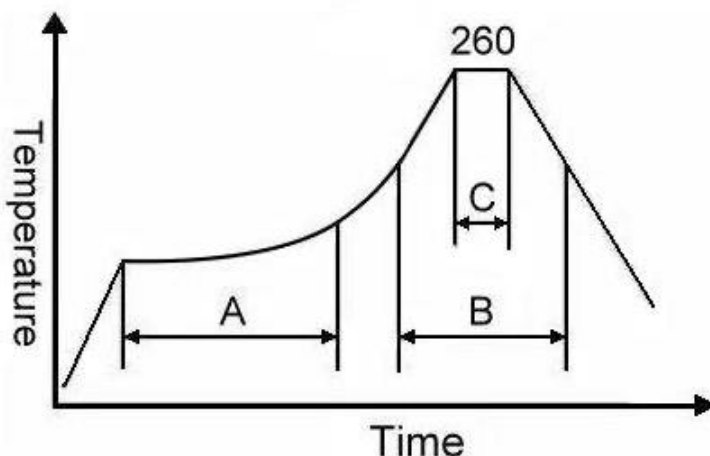

Note:

	Stage	Temperature	Time
A	Preheat	150~200°C	60~120 Sec
B	Primary Heat	217°C	60~150 Sec
C	Peak	260°C	10 Sec

For soldering reflow profile and reliability test ratings go to: <http://www.pericom.com/pdf/sre/reflow.pdf>

# TYPE GB 49S QUARTZ CRYSTAL

**GB0800004**

VER.B 13-JUN-16

## MARKING

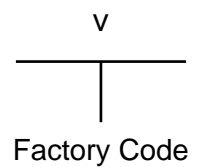
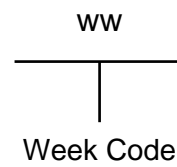
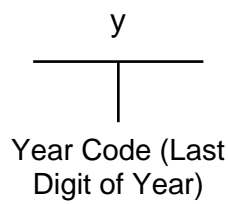
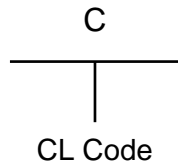
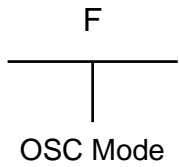
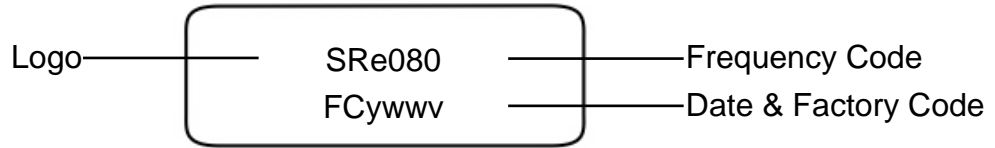

## MECHANICAL DRAWINGS ( Scale: None. Dimensions are in mm.)

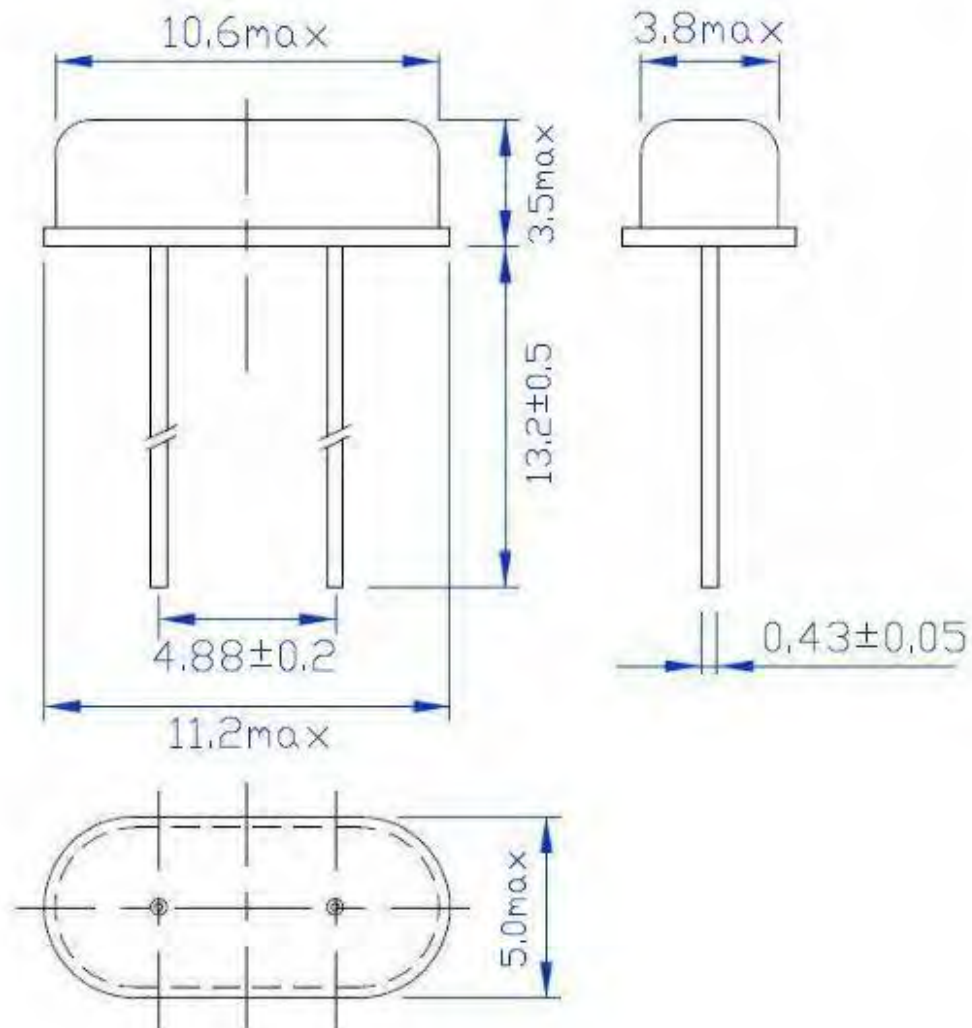

# TYPE GB 49S QUARTZ CRYSTAL

**GB0800004**

VER.B 13-JUN-16

## PACKING

