



PRODUCT SPECIFICATION



LANGUAGE

JAPANESE
ENGLISH

【 1 . 適用範囲 SCOPE 】

本仕様書は、 _____ 殿 に納入する
0.5mm ピッチ FFC 対 基板 用 コネクタ について規定する。

This specification covers the 0.5mm PITCH FFC TO BOARD CONNECTOR series

【 2 . 製品名称及び型番 PRODUCT NAME AND PART NUMBER 】

製品名称 Product Name		製品型番 Material Number
ハウジングアセンブリ Housing Assembly (ST Type)	無鉛 LEAD FREE	501786-**11
501786-**11 テーピング梱包 Embossed Tape Package for 501786-**11	無鉛 LEAD FREE	501786-**90
プラグジャケット Plug Jacket	無鉛 LEAD FREE	501783-**09
プラグジャケットカバー Plug Jacket Cover	無鉛 LEAD FREE	501784-**09

* : 図面参照 Refer to the drawings.

【 3 . 定格 RATINGS 】

項目 Item	規格 Standard	
最大許容電圧 Rated Voltage (MAX.)	50 V ²	[AC (実効値 rms) /DC]
最大許容電流 Rated Current (MAX.)	0.5 A ²	
使用温度範囲 Ambient Temperature Range	-40 ~ +85 *1*2	

*1 : 通電による温度上昇分を含む。
Including terminal temperature rise.

*2 : 使用FFCも本定格を満足すること。
FFC must be met ratings specified in this standard.

REV.	A	A	A	A	A	A	A	A	A	A	A	A	A	A	A	A							
SHEET	1	2	3	4	5	6	7	8	9	10	11	12	13	14	15								
REVISE ON PC ONLY							TITLE: 0.5 mm PITCH FFC TO BOARD CONNECTOR -LEAD FREE- 製品仕様書																
A	新規作成 RELEASED J2006-1206 '05/10/20 H.IIJIMA						THIS DOCUMENT CONTAINS INFORMATION THAT IS PROPRIETARY TO MOLEX INC. AND SHOULD NOT BE USED WITHOUT WRITTEN PERMISSION																
REV.	DESCRIPTION						WRITTEN BY: H.IIJIMA	CHECKED BY: K.TAKAHASHI	APPROVED BY: H.HIRATA	DATE: YR/MO/DAY 2005/10/20													
DESIGN CONTROL J							STATUS		FILE NAME			SHEET											
DOCUMENT NUMBER PS-501786-001										PS501786001.doc							1 OF 15						



PRODUCT SPECIFICATION



LANGUAGE

JAPANESE
ENGLISH

【 4 . 性 能 PERFORMANCE】

4 - 1 . 電 気 的 性 能 Electrical Performance

項 目 Item		条 件 Test Condition	規 格 Requirement
4-1-1	接 触 抵 抗 Contact Resistance	適合FFCハーネスを嵌合させ、開放電圧 20mV 以下、 短絡電流 10mA 以下 にて測定する。 (JIS C5402 5.4) Mate applicable FFC Harness, measure by dry circuit, 20mV MAX., 10mA MAX. (JIS C5402 5.4)	40 milliohm MAX.
4-1-2	絶 縁 抵 抗 Insulation Resistance	適合FFCハーネスを嵌合させ、隣接するターミナル間 及びターミナル、アース間に、DC 500V を印加し測定 する。 (JIS C5402 5.2/MIL-STD-202 試験法 302) Mate applicable FFC Harness and apply 500V DC between adjacent terminal and ground. (JIS C5402 5.2/MIL-STD-202 Method 302)	50 Megohm MIN.
4-1-3	耐 電 圧 Dielectric Strength	適合FFCハーネスを嵌合させ、隣接するターミナル間 及びターミナル、アース間に、AC 250V (実効値) を 1 分間 印加する。 (JIS C5402 5.1/MIL-STD-202 試験法 301) Mate applicable FFC Harness, apply 250V AC (rms) for 1 minute between adjacent terminal or ground. (JIS C5402 5.1/MIL-STD-202 Method 301)	異状なきこと No Breakdown

4 - 2 . 機 械 的 性 能 Mechanical Performance

項 目 Item		条 件 Test Condition	規 格 Requirement
4-2-1	挿 入 ・ 抜 去 力 Insertion Force/ Withdrawal Force	ロックを解除した状態にて、毎分 25 ± 3 mm の 速さで挿入・抜去を行う。 Insert and withdraw connectors, at the speed rate of 25 ± 3 mm per minute.	第6項参照 Refer to paragraph 6
4-2-1	強 制 抜 去 力 Compulsion Withdrawal Force	適合FFCハーネスを嵌合させ、ロックを解除せず に毎分 25 ± 3 mm の速さで軸方向にを引き抜く。 Mate applicable FFC Harness, apply axial pull out force at the speed rate of 25 ± 3 mm per minute.	9.8 N{ 1.0 kgf} MINIMUM

REVISE ON PC ONLY		TITLE: 0.5 mm PITCH FFC TO BOARD CONNECTOR -LEAD FREE- 製品仕様書	
A	SEE SHEET 1 OF 10	THIS DOCUMENT CONTAINS INFORMATION THAT IS PROPRIETARY TO MOLEX INC. AND SHOULD NOT BE USED WITHOUT WRITTEN PERMISSION	
REV.	DESCRIPTION	FILE NAME PS501786001.doc	SHEET 2 OF 15
DOCUMENT NUMBER PS-501786-001		EN-37-1(019)	



PRODUCT SPECIFICATION



LANGUAGE

JAPANESE
ENGLISH

4 - 3 . そ の 他 Environmental Performance and Others

項 目 Item		条 件 Test Condition	規 格 Requirement	
4-3-1	繰り返し挿抜 Repeated Mate / Un-matel	無通電状態にて、1分間に10回以下の速さで挿入、抜去を20回繰り返す。 When mated up to 20 cycles repeatedly at the speed rate of less than 10 cycles per minute.	接触抵抗 Contact Resistance	60 milliohm MAX.
4-3-2	温度上昇 Temperature Rise	適合FFCハーネスを嵌合させ、最大許容電流を通電し、コネクタの温度上昇分を測定する。 (UL 498) Carrying rated current load. (UL 498)	温度上昇 Temperature Rise	30 °C MAX.
4-3-3	耐振動性 Vibration	DC 1mA 通電状態にて、嵌合軸を含む互いに垂直な3方向に掃引割合10~55~10Hz/分、全振幅1.5mmの振動を各2時間加える。 (MIL-STD-202試験法 201) Amplitude : 1.5 mm P-P Sweep time : 10-55-10 Hz in 1 minutes Duration : 2 hours in each X.Y.Z axes (MIL-STD-202, Method 201)	外 観 Appearance	異常なきこと No Damage
			接触抵抗 Contact Resistance	60 milliohm MAX.
			瞬断 Discontinuity	1 microsecond MAX
4-3-4	耐衝撃性 Shock	DC 1mA 通電状態にて、嵌合軸を含む互いに垂直な6方向に490m/s ² {50G}の衝撃を各3回加える。 (JIS C041 / MIL-STD-202試験法 213) 490m/s ² {50 G}, 3 strokes in each X.Y.Z. axes. (JIS C0041/MIL-STD-202 Method 213)	外 観 Appearance	異常なきこと No Damage
			接触抵抗 Contact Resistance	60 milliohm MAX.
			瞬断 Discontinuity	1 microsecond MAX.
4-3-5	耐熱性 Heat Resistance	適合FFCハーネスを嵌合させ、85±2の雰囲気中に96時間放置後取り出し、1~2時間室温に放置する。 (JIS C0021/MIL-STD-202 試験法 108) 85±2 , 96 hours (JIS C0021/MIL-STD-202 Method 108)	外 観 Appearance	異常なきこと No Damage
			接触抵抗 Contact Resistance	60 milliohm MAX.

REVISE ON PC ONLY

A

SEE SHEET 1 OF 10

TITLE:

0.5 mm PITCH FFC TO BOARD CONNECTOR

-LEAD FREE-

製品仕様書

THIS DOCUMENT CONTAINS INFORMATION THAT IS PROPRIETARY TO MOLEX INC. AND SHOULD NOT BE USED WITHOUT WRITTEN PERMISSION

REV.

DESCRIPTION

DOCUMENT NUMBER

PS-501786-001

FILE NAME

PS501786001.doc

SHEET

3 OF 15

EN-37-1(019)



PRODUCT SPECIFICATION



LANGUAGE

JAPANESE
ENGLISH

項目 Item		条件 Test Condition	規格 Requirement	
4-3-6	耐寒性 Cold Resistance	適合FFCハーネスを嵌合させ、 -40 ± 2 の 雰囲気中に96時間 放置後取り出し、1~2時間 室温に放置する。 (JIS C0020) -40 ± 2 , 96 hours (JIS C0020)	外観 Appearance	異常なきこと No Damage
			接触抵抗 Contact Resistance	60 milliohm MAX.
4-3-7	耐湿性 Humidity	適合FFCハーネスを嵌合させ、 60 ± 2 相対 湿度 90~95% の雰囲気中に 96時間 放置後 取り出し、1~2時間 室温に放置する。 (JIS C0022/MIL-STD-202 試験方法103) Temperature: 60 ± 2 Relative Humidity: 90~95% Duration: 500 hours (JIS C0022/MIL-STD-202 Method 103)	外観 Appearance	異常なきこと No Damage
			接触抵抗 Contact Resistance	60 milliohm MAX.
			耐電圧 Dielectric Strength	4-1-3項満足のこと Must meet 4-1-3
			絶縁抵抗 Insulation Resistance	20 Megohm MIN.
4-3-8	温度サイクル Temperature Cycling	適合FFCハーネスを嵌合させ、 -55 ± 3 に30分、 $+85 \pm 2$ に 30分、これを 1サイクル とし、 5サイクル 繰り返す。 但し、温度移行時間は 5分以内 とする。 試験後 1~2時間 室温に放置する。 (JIS C0025) 5 cycles of : a) -55 ± 3 30minutes b) $+85 \pm 2$ 30minutes (JIS C0025)	外観 Appearance	異常なきこと No Damage
			接触抵抗 Contact Resistance	60 milliohm MAX.

REVISE ON PC ONLY		TITLE: 0.5 mm PITCH FFC TO BOARD CONNECTOR -LEAD FREE- 製品仕様書	
A	SEE SHEET 1 OF 10	THIS DOCUMENT CONTAINS INFORMATION THAT IS PROPRIETARY TO MOLEX INC. AND SHOULD NOT BE USED WITHOUT WRITTEN PERMISSION	
REV.	DESCRIPTION	FILE NAME PS501786001.doc	SHEET 4 OF 15
DOCUMENT NUMBER PS-501786-001		EN-37-1(019)	



PRODUCT SPECIFICATION



LANGUAGE

JAPANESE
ENGLISH

項目 Item		条件 Test Condition	規格 Requirement	
4-3-9	亜硫酸ガス SO ₂ Gas	適合FFCハーネスを嵌合させ、40±2 にて 50±5ppmの亜硫酸ガス中に 24時間放置する。 24 hours exposure to 50±5ppm. SO ₂ gas at 40±2	接触抵抗 Contact Resistance	60 milliohm MAX.
4-3-10	耐アンモニア性 NH ₃ Gas	適合FFCハーネスを嵌合させ、濃度 28% の アンモニア水を入れた容器中に 40分間 放置 する。 (1Lに対して25mLの割合) 40 minutes exposure to NH ₃ gas evaporating from 28% Ammonia solution.	接触抵抗 Contact Resistance	60 milliohm MAX.
4-3-11	半田付け性 Solder Ability	端子先端より 0.3mm、金具先端より 0.3mm の位置まで、245±3 の半田に 3±0.5秒 浸 す。 Soldering Time : 3±0.5 seconds Solder Temperature : 245±3 0.3mm from terminal tip. 0.3mm from fitting nail tip.	濡れ性 Solder Wetting	浸漬面積の 75%以上 75% of immersed area must show no voids, pin holes.
4-3-12	半田耐熱性 Resistance to Soldering Heat	(リフロー時) 第7項参照。 (When reflowing) Refer to paragraph 7.	外 観 Appearance	端子ガタ、 割れ等 異状無き事 No Damage
		(手半田) 端子先端より 0.3mm、金具先端より 0.3mm の位置まで 350±10 の半田ゴテにて 3秒 加熱する。 (Soldering iron method) Solder time : 3 seconds Solder temperature : 350±10 0.3mm from terminal tip. 0.3mm from fitting nail tip.		

() : 参考規格 Reference Standard

{ } : 参考単位 Reference Unit

REVISE ON PC ONLY		TITLE: 0.5 mm PITCH FFC TO BOARD CONNECTOR	
A	SEE SHEET 1 OF 10	-LEAD FREE- 製品仕様書	
		THIS DOCUMENT CONTAINS INFORMATION THAT IS PROPRIETARY TO MOLEX INC. AND SHOULD NOT BE USED WITHOUT WRITTEN PERMISSION	
REV.	DESCRIPTION	FILE NAME	SHEET
DOCUMENT NUMBER PS-501786-001		PS501786001.doc	5 OF 15



PRODUCT SPECIFICATION



LANGUAGE

JAPANESE
ENGLISH**【 5 . 外観形状、寸法及び材質 PRODUCT SHAPE, DIMENSIONS AND MATERIALS 】**

図面参照 Refer to the drawing.

【 6 . 挿入・抜去力 INSERTION FORCE/WITHDRAWAL FORCE 】下記の F F C を使用した場合のテストデータ (参考)
This test data in case of used the following FFC(Reference)F F C : 住友電気工業株式会社 製
FFC : SUMITOMO ELECTRIC INDUSTRIES, LTD.
厚さ (導体部) : 0.3 mm
Thickness (CONDUCTOR AREA) : 0.3 mm

(N=5)

極数 No.	of CKT	単位 UNIT	挿入力 Retention Force			抜去力 Withdrawal Force		
			平均値 AVG.	最大値 MAX.	最小値 MIN.	平均値 AVG.	最大値 MAX.	最小値 MIN.
40	初回 1st	N {kgf}	11.25 {1.15}	11.9 {1.21}	10.4 {1.06}	7.45 {0.76}	7.8 {0.80}	7.1 {0.72}
	10回目 10th	N {kgf}	10.80 {1.10}	11.2 {1.14}	10.4 {1.06}	7.25 {0.74}	7.8 {0.80}	6.5 {0.66}
	20回目 20th	N {kgf}	10.70 {1.09}	10.9 {1.11}	10.5 {1.07}	7.53 {0.77}	8.0 {0.82}	7.2 {0.73}
50	初回 1st	N {kgf}	12.02 {1.23}	13.2 {1.35}	11.0 {1.12}	10.26 {1.05}	10.9 {1.11}	9.6 {0.98}
	10回目 10th	N {kgf}	11.44 {1.17}	12.7 {1.30}	10.0 {1.02}	9.44 {0.96}	10.2 {1.04}	9.2 {0.94}
	20回目 20th	N {kgf}	11.70 {1.19}	13.0 {1.33}	10.3 {1.05}	9.8 {1.00}	10.6 {1.08}	9.3 {0.95}
80	初回 1st	N {kgf}	19.25 {1.96}	20.1 {2.05}	18.4 {1.88}	11.30 {1.15}	12.6 {1.29}	10.7 {1.09}
	10回目 10th	N {kgf}	18.95 {1.96}	19.8 {2.02}	17.5 {1.75}	11.63 {1.18}	12.6 {1.29}	10.9 {1.11}
	20回目 20th	N {kgf}	18.78 {1.92}	19.8 {2.02}	17.6 {1.80}	12.25 {1.25}	13.3 {1.36}	11.5 {1.17}

* 40,50極は80極データからの想定値となります。

REVISE ON PC ONLY		TITLE: 0.5 mm PITCH FFC TO BOARD CONNECTOR -LEAD FREE- 製品仕様書	
A	SEE SHEET 1 OF 10	THIS DOCUMENT CONTAINS INFORMATION THAT IS PROPRIETARY TO MOLEX INC. AND SHOULD NOT BE USED WITHOUT WRITTEN PERMISSION	
REV.	DESCRIPTION	DOCUMENT NUMBER PS-501786-001	FILE NAME PS501786001.doc SHEET 6 OF 15

EN-37-1(019)



【 7 . 赤外線リフロー条件 INFRARED REFLOW CONDITION 】

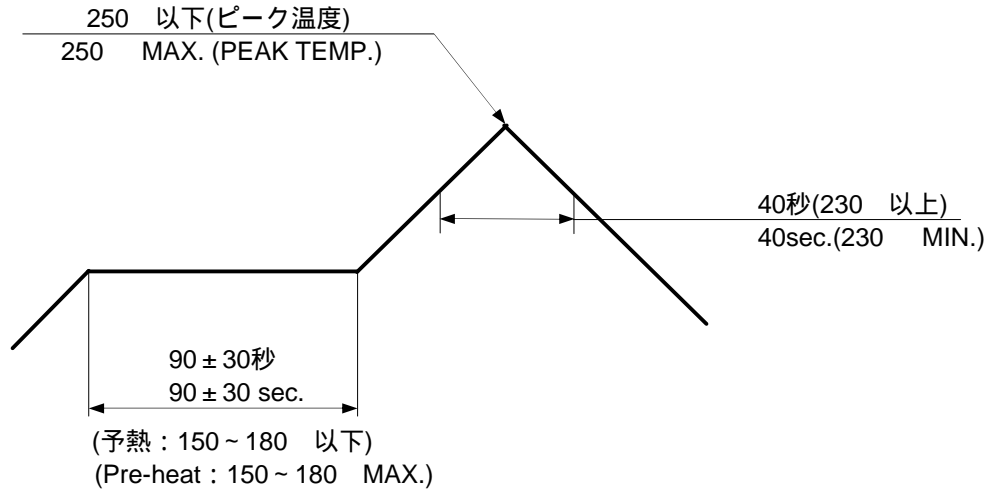

温度条件グラフ
(温度は基板パターン面)

TEMPERATURE CONDITION GRAPH
(TEMPERATURE ON THE SURFACE OF P.C.BOARD PATTERN)

注記 ; 本リフロー条件に関しては、リフロー装置及び基板などにより条件が異なりますので、事前にリフロー評価の確認をお願い致します。

NOTE ; Please check the reflow soldering condition by your own devices beforehand. Because the condition changes by the soldering devices, P.C.Boards, and so on.

REVISE ON PC ONLY		TITLE:	
A	SEE SHEET 1 OF 10	0.5 mm PITCH FFC TO BOARD CONNECTOR	
	REV.	DESCRIPTION	-LEAD FREE- 製品仕様書
DOCUMENT NUMBER		FILE NAME	SHEET
PS-501786-001		PS501786001.doc	7 OF 15
EN-37-1(019)			



【 8 . 使用上の注意事項 INSTRUCTION UPON USAGE 】

8 - 1 . 各部の名称

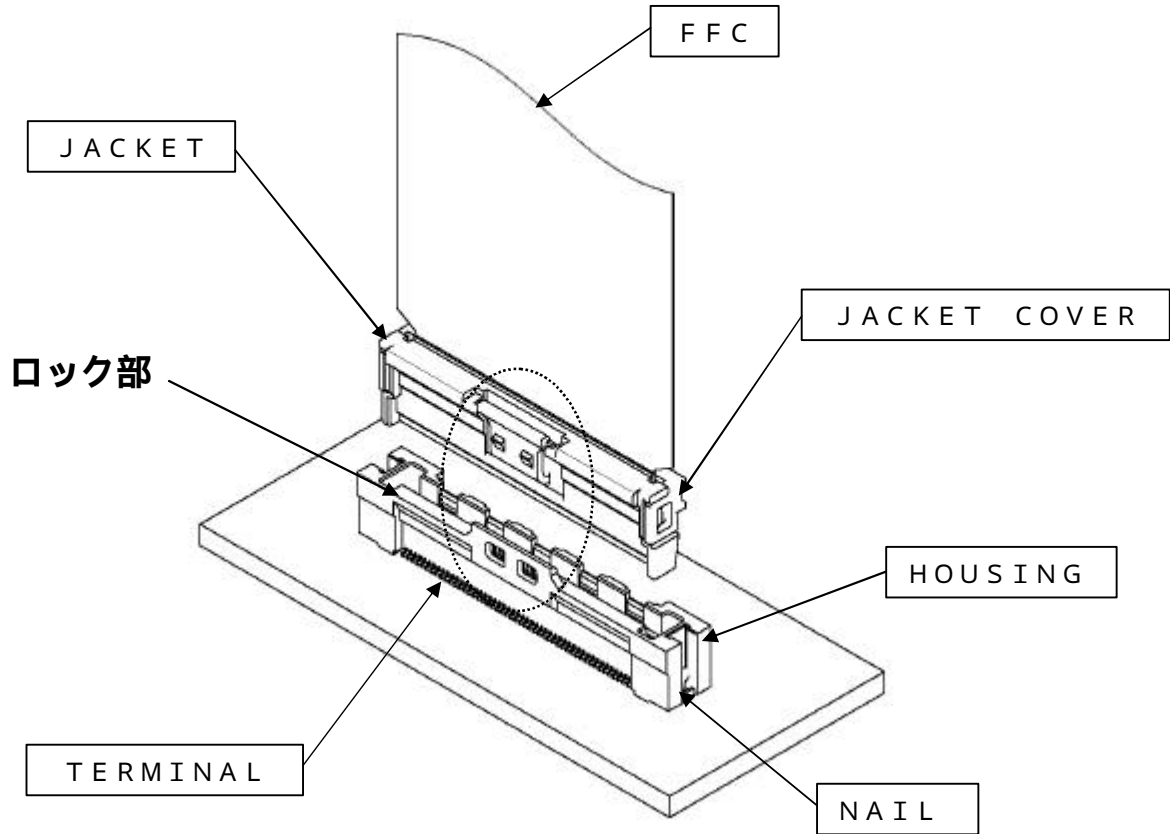

8 - 2 . 基板への実装に関して Mounting on the PC Board

基板への実装は実装機にて実施願います。もし、手半田する場合は、TERMINAL及びNAIL等に触れない様に願います。(半田付け不良等の原因となる可能性が有ります。)

The mounting of the PC board is handled by the mouter. If to manually solder, please be cautious to not touch the Terminal and Fitting Nail.(It will create the possibility to cause solderbility failure.)

REVISE ON PC ONLY		TITLE: 0.5 mm PITCH FFC TO BOARD CONNECTOR	
A	SEE SHEET 1 OF 10	-LEAD FREE- 製品仕様書	
REV.	DESCRIPTION	THIS DOCUMENT CONTAINS INFORMATION THAT IS PROPRIETARY TO MOLEX INC. AND SHOULD NOT BE USED WITHOUT WRITTEN PERMISSION	
DOCUMENT NUMBER PS-501786-001		FILE NAME PS501786001.doc	SHEET 8 OF 15
EN-37-1(019)			



8 - 3 . コネクタ嵌合に関して

コネクタを嵌合する際は、JACKETとJACKET COVERの全体もしくは中央を掴んで挿入を実施ください。

When mating the connector, hold the JACKET AND JACKET COVER together at either a whole or the center portion of them to insert.

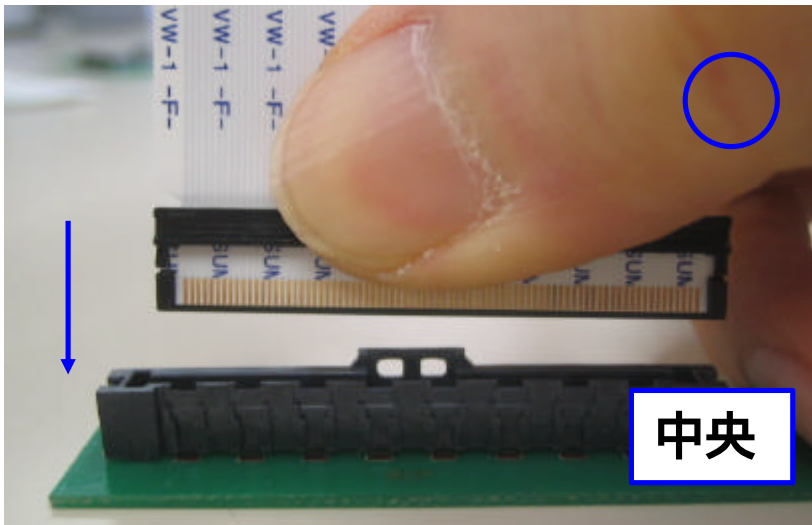
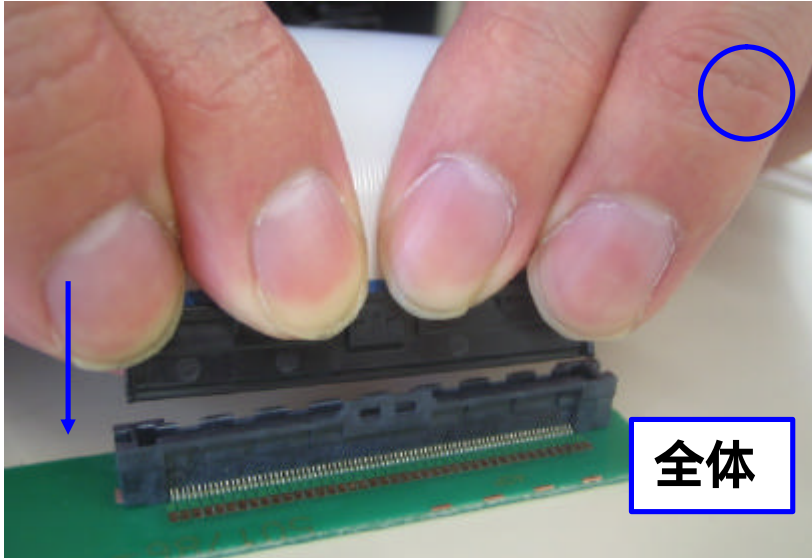

	REVISE ON PC ONLY		TITLE: 0.5 mm PITCH FFC TO BOARD CONNECTOR -LEAD FREE- 製品仕様書
	A	SEE SHEET 1 OF 10	
REV.	DESCRIPTION		THIS DOCUMENT CONTAINS INFORMATION THAT IS PROPRIETARY TO MOLEX INC. AND SHOULD NOT BE USED WITHOUT WRITTEN PERMISSION
DOCUMENT NUMBER PS-501786-001			FILE NAME PS501786001.doc
			SHEET 9 OF 15
EN-37-1(019)			



以下のような嵌合は回復不可能な機能不全や製品破壊につながりますので実施しないで下さい。
The following method of mating will cause either irreversable functionality failure or product breaking, so please do not mate this way.

- ・ F F Cのみを掴まないでください。
Please do not hold the FFC part only



- ・ J A C K E TとJ A C K E T C O V E Rの 端部のみを掴まないでください。
Please do not hold the JACKET AND edge of the JACKET COVER only

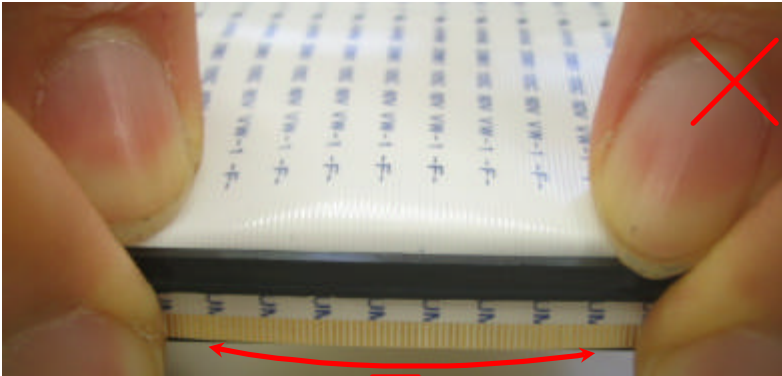

REVISE ON PC ONLY		TITLE:	
A	SEE SHEET 1 OF 10	0.5 mm PITCH FFC TO BOARD CONNECTOR	
	REV.	DESCRIPTION	-LEAD FREE- 製品仕様書
DOCUMENT NUMBER		FILE NAME	SHEET
PS-501786-001		PS501786001.doc	10 OF 15
EN-37-1(019)			



- ・ F F C を折り曲げるように掴まないでください。
Please do not hold the FFC like bending it.

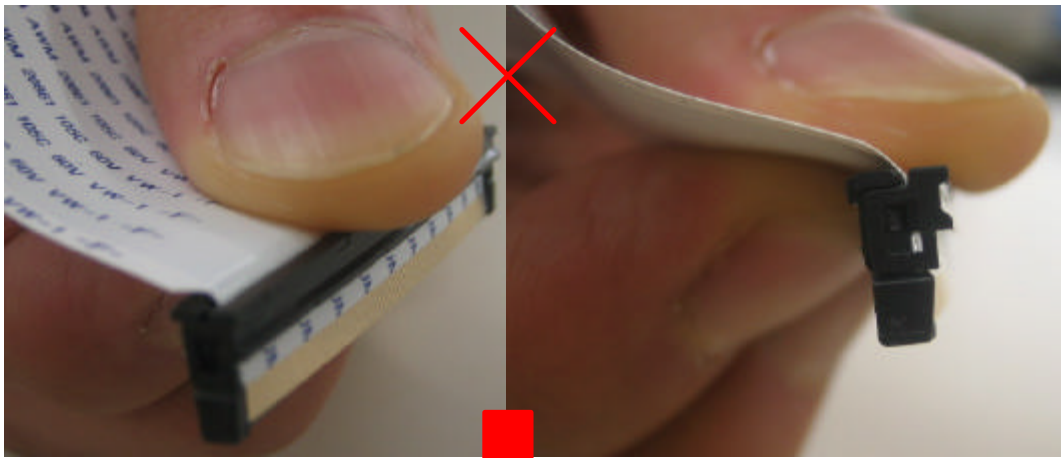

	REVISE ON PC ONLY		TITLE: 0.5 mm PITCH FFC TO BOARD CONNECTOR -LEAD FREE- 製品仕様書	THIS DOCUMENT CONTAINS INFORMATION THAT IS PROPRIETARY TO MOLEX INC. AND SHOULD NOT BE USED WITHOUT WRITTEN PERMISSION
	A	SEE SHEET 1 OF 10		
REV.	DESCRIPTION		FILE NAME	SHEET
DOCUMENT NUMBER PS-501786-001			PS501786001.doc	11 OF 15
EN-37-1(019)				



FFCが極端に浮くと、嵌合時にHOUSINGと干渉し座屈する可能性があります。
If FFC warps too much, it will touch with the Header housing when mated,
and may possibly cause buckling.

FFCの極端な浮き
TO WARPED FFC

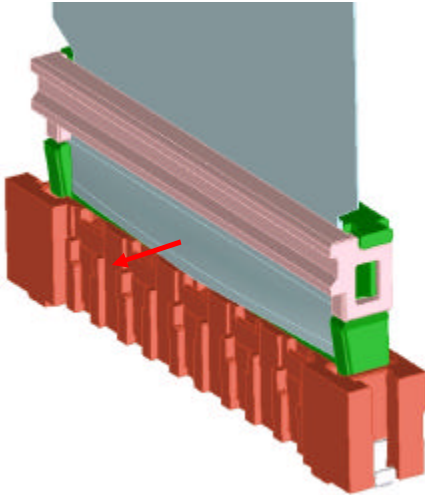

干渉
TOUCH

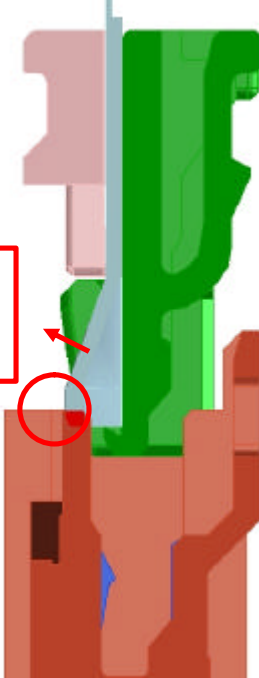

- ・ JACKETとJACKET COVERの片端のみを掴まないでください。
斜め嵌合となり、不良につながります。
Please do not hold one side of the JACKET and the JACKET COVER only as shown below.
It will be mated in the slant direction and will cause failure

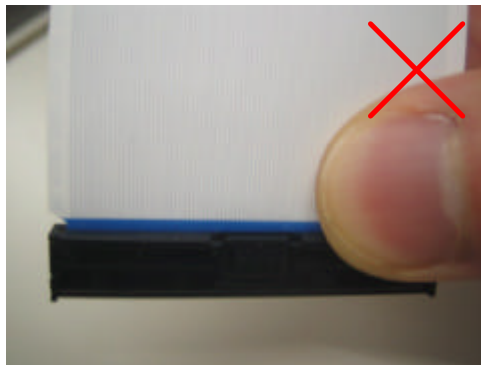

REVISE ON PC ONLY		TITLE:	
A	SEE SHEET 1 OF 10	0.5 mm PITCH FFC TO BOARD CONNECTOR	
	REV.	DESCRIPTION	-LEAD FREE- 製品仕様書
DOCUMENT NUMBER		THIS DOCUMENT CONTAINS INFORMATION THAT IS PROPRIETARY TO MOLEX INC. AND SHOULD NOT BE USED WITHOUT WRITTEN PERMISSION	
PS-501786-001		FILE NAME	SHEET
		PS501786001.doc	12 OF 15
EN-37-1(019)			



- ・斜め嵌合は不良につながりますので実施しないでください。
Mating inconsistently will cause failure, so please do not do this.

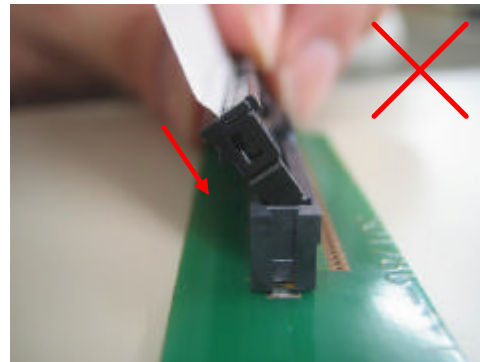
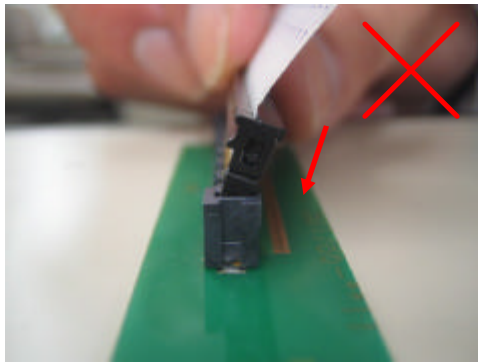
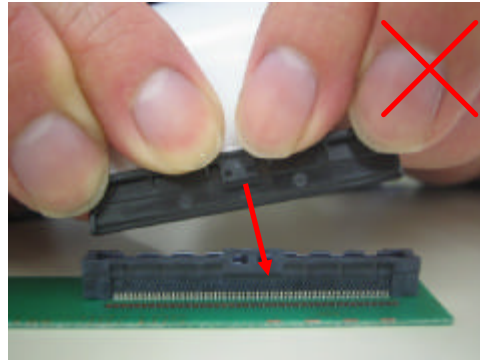
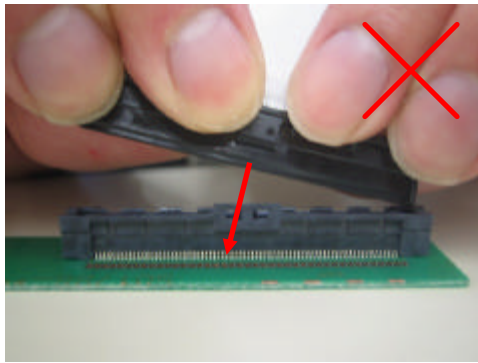

- ・嵌合状態 及び 嵌合時の F F C 引き回し作業においてロック部に無理な負荷が掛かるような使用は避けてください。
Please be cautious not to put excess load at the lock part after mating and when FFC is pulled and extracted.

REVISE ON PC ONLY		TITLE:	
A	SEE SHEET 1 OF 10	0.5 mm PITCH FFC TO BOARD CONNECTOR	
		-LEAD FREE- 製品仕様書	
		THIS DOCUMENT CONTAINS INFORMATION THAT IS PROPRIETARY TO MOLEX INC. AND SHOULD NOT BE USED WITHOUT WRITTEN PERMISSION	
REV.	DESCRIPTION	FILE NAME	SHEET
	PS-501786-001	PS501786001.doc	13 OF 15
DOCUMENT NUMBER		EN-37-1(019)	



コネクタの嵌合を取り外す際は、必ずロック解除して実施ください。
Please be sure to release the lock when unmating the connector.

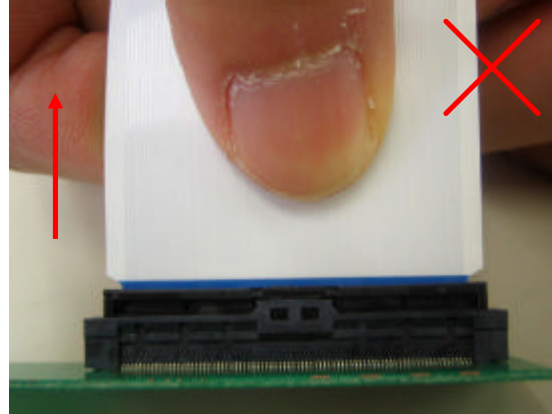
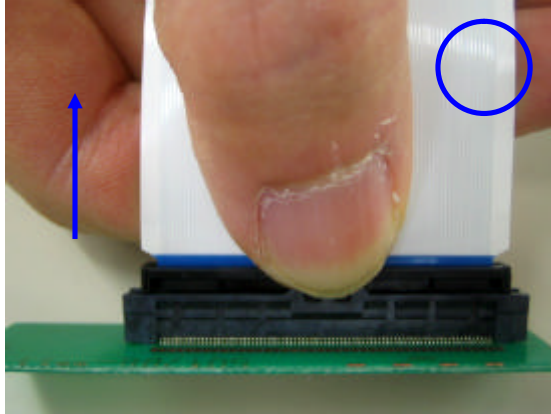

REVISE ON PC ONLY		TITLE:	
A	SEE SHEET 1 OF 10	0.5 mm PITCH FFC TO BOARD CONNECTOR	
REV.	DESCRIPTION	-LEAD FREE-	製品仕様書
		THIS DOCUMENT CONTAINS INFORMATION THAT IS PROPRIETARY TO MOLEX INC. AND SHOULD NOT BE USED WITHOUT WRITTEN PERMISSION	
DOCUMENT NUMBER PS-501786-001		FILE NAME PS501786001.doc	SHEET 14 OF 15
EN-37-1(019)			

