

### 64ns Sample and Hold Amplifier

The HA5351 is a fast acquisition, wide bandwidth sample and hold amplifier, built with the Intersil HBC-10 BiCMOS process. This sample and hold amplifier offers a combination of desirable features; fast acquisition time (70ns to 0.01% maximum), excellent DC precision and extremely low power dissipation, making it ideal for use in systems that sample multiple signals and require low power.

The HA5351 is in an open loop configuration with fully differential inputs providing flexibility for user defined feedback. In unity gain the HA5351 is completely self-contained and requires no external components. The on-chip 15pF hold capacitor is completely isolated to minimizing droop rate and reducing sensitivity to pedestal error. The HA5351 is available in 8 lead SOIC package for minimizing board space and ease of layout.

### Ordering Information

PART NUMBER (Note)	PART MARKING	TEMP. RANGE (°C)	PACKAGE (Pb-free)	PKG. DWG. #
HA5351BZ	5351 IBZ	-40 to +85	8 Ld SOIC	M8.15

NOTE: Intersil Pb-free plus anneal products employ special Pb-free material sets; molding compounds/die attach materials and 100% matte tin plate termination finish, which are RoHS compliant and compatible with both SnPb and Pb-free soldering operations. Intersil Pb-free products are MSL classified at Pb-free peak reflow temperatures that meet or exceed the Pb-free requirements of IPC/JEDEC J STD-020.

### Functional Diagram

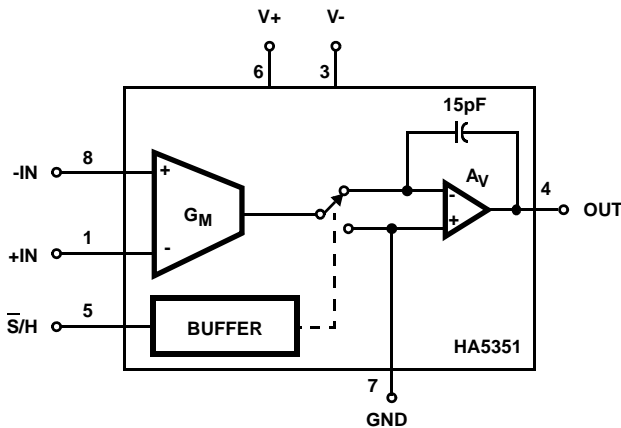

### Features

- Fast Acquisition to 0.01% . . . . . 70ns (Max)
- Low Offset Error . . . . . ±2mV (Max)
- Low Pedestal Error . . . . . ±10mV (Max)
- Low Droop Rate . . . . . 2µV/µs (Max)
- Wide Unity Gain Bandwidth . . . . . 40MHz
- Low Power Dissipation . . . . . 220mW (Max)
- Total Harmonic Distortion (Hold Mode) . . . . . -72dBc  
- (VIN = 5V<sub>P-P</sub> at 1MHz)
- Fully Differential Inputs
- On Chip Hold Capacitor
- Pb-Free (RoHS Compliant)

### Applications

- Synchronous Sampling
- Wide Bandwidth A/D Conversion
- Deglitching
- Peak Detection
- High Speed DC Restore

### Pinout

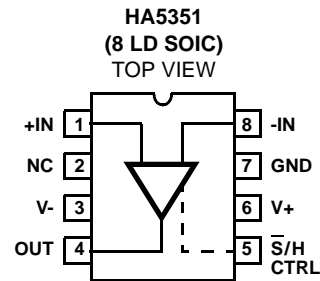

**Absolute Maximum Ratings**

Voltage Between V+ and V- Terminals . . . . . +11V  
 Differential Input Voltage . . . . . 6V  
 Voltage Between Sample and Hold Control and Ground . . . . . +5.5V  
 Output Current, Continuous . . . . . ±37mA

**Thermal Information**

Thermal Resistance (Typical, Note 1)  $\theta_{JA}$  (°C/W)  
 SOIC Package . . . . . 160  
 Maximum Junction Temperature (Plastic Package) . . . . . +150°C  
 Maximum Storage Temperature Range . . . . . -65°C to +150°C  
 Pb-Free Reflow Profile see link below  
<http://www.intersil.com/pbfree/Pb-FreeReflow.asp>

**Operating Conditions**

Temperature Range . . . . . -40°C to +85°C

*CAUTION: Stresses above those listed in "Absolute Maximum Ratings" may cause permanent damage to the device. This is a stress only rating and operation of the device at these or any other conditions above those indicated in the operational sections of this specification is not implied.*

**NOTE:**

1.  $\theta_{JA}$  is measured with the component mounted on an evaluation PC board in free air.

**Electrical Specifications**

Test Conditions:  $V_{SUPPLY} = \pm 5V$ ;  $C_H = \text{Internal} = 15pF$ , Digital Input:  $V_{IL} = 0V$  (Sample),  $V_{IH} = 4.0V$  (Hold).  
 Non-Inverting Unity Gain Configuration (Output Tied to -Input),  $C_L = 5pF$ ,  
 Unless Otherwise Specified

PARAMETER	TEST CONDITIONS	TEMP. (°C)	MIN	TYP	MAX	UNITS
<b>INPUT CHARACTERISTICS</b>						
Input Voltage Range		Full	-2.5	-	+2.5	V
Input Resistance (Note 2)		+25	100	500	-	k $\Omega$
Input Capacitance		+25	-	-	5	pF
Input Offset Voltage		+25	-2	-	2	mV
		Full	-3.0	-	3.0	mV
Offset Voltage Temperature Coefficient		Full	-	15	-	$\mu V/^\circ C$
Bias Current		Full	-	2.5	5	$\mu A$
Offset Current		Full	-1.5	-	+1.5	$\mu A$
Common Mode Range		Full	-2.5	-	+2.5	V
Common Mode Rejection Ratio	±2.5V, Note 3	Full	60	80	-	dB
<b>TRANSFER CHARACTERISTICS</b>						
Large Signal Voltage Gain	$V_{OUT} = \pm 2.5V$	+25	95	108	-	dB
		Full	85	-	-	dB
Unity Gain -3dB Bandwidth		25	-	40	-	MHz
<b>TRANSIENT RESPONSE</b>						
Rise Time	200mV Step	+25	-	8.5	-	ns
Overshoot	200mV Step	+25	0	-	30	%
Slew Rate	5V Step	Full	88	105	-	V/ $\mu s$
<b>DIGITAL INPUT CHARACTERISTICS</b>						
Input Voltage	$V_{IH}$	+25, +85	2.1	-	5.0	V
		-40	2.4	-	5.0	V
	$V_{IL}$	Full	0	-	0.8	V
Input Current	$V_{IL} = 0V$	Full	-1.0	-	1.0	$\mu A$
	$V_{IH} = 5V$	Full	-1.0	-	1.0	$\mu A$
<b>OUTPUT CHARACTERISTICS</b>						
Output Voltage	$R_L = 510\Omega$	Full	-3.0	-	+3.0	V
Output Current	$R_L = 100\Omega$	+25, +85	20	25	-	mA
		-40	15	-	-	mA
Full Power Bandwidth	5V <sub>p-p</sub> , $A_V = +1, -3dB$	Full	-	13	-	MHz
Output Resistance	Hold Mode	+25	-	0.02	-	$\Omega$
Total Output Noise (DC to 10MHz)	Sample Mode	+25	-	325	-	$\mu V_{RMS}$
	Hold Mode	+25	-	325	-	$\mu V_{RMS}$

# HA5351

**Electrical Specifications** Test Conditions:  $V_{SUPPLY} = \pm 5V$ ;  $C_H = \text{Internal} = 15pF$ , Digital Input:  $V_{IL} = 0V$  (Sample),  $V_{IH} = 4.0V$  (Hold).  
Non-Inverting Unity Gain Configuration (Output Tied to -Input),  $C_L = 5pF$ ,  
Unless Otherwise Specified **(Continued)**

PARAMETER	TEST CONDITIONS	TEMP. (°C)	MIN	TYP	MAX	UNITS
<b>DISTORTION CHARACTERISTICS</b>						
SAMPLE MODE						
Total Harmonic Distortion	$V_{IN} = 4.5V_{P-P}$ , $f_{IN} = 100kHz$	+25	-	-80	-	dBc
	$V_{IN} = 5V_{P-P}$ , $f_{IN} = 1MHz$	+25	-	-74	-	dBc
	$V_{IN} = 1V_{P-P}$ , $f_{IN} = 10MHz$	+25	-	-57	-	dBc
Signal to Noise Ratio (RMS Signal to RMS Noise)	$V_{IN} = 4.5V_{P-P}$ , $f_{IN} = 100kHz$	+25	-	73	-	dB
HOLD MODE (50% Duty Cycle S/H)						
Total Harmonic Distortion	$V_{IN} = 4.5V_{P-P}$ , $f_{IN} = 100kHz$ , $f_S \cong 100kHz$	+25	-	-78	-	dBc
	$V_{IN} = 5V_{P-P}$ , $f_{IN} = 1MHz$ , $f_S \cong 1MHz$	+25	-	-72	-	dBc
	$V_{IN} = 1V_{P-P}$ , $f_{IN} = 10MHz$ , $f_S \cong 1MHz$	+25	-	-51	-	dBc
Signal to Noise Ratio (RMS Signal to RMS Noise)	$V_{IN} = 4.5V_{P-P}$ , $f_{IN} = 100kHz$ , $f_S \cong 100kHz$	+25	-	70	-	dB
<b>SAMPLE AND HOLD CHARACTERISTICS</b>						
Acquisition Time	0V to 2.0V Step to $\pm 1mV$	+25	-	53	-	ns
	0V to 2.0V Step to 0.01% ( $\pm 200\mu V$ )	+25	-	64	70	ns
	-2.5V to +2.5V Step to 0.01% ( $\pm 500\mu V$ )	+25	-	90	100	ns
Droop Rate		+25	-	0.3	-	$\mu V/\mu s$
		Full	-2	-	2	$\mu V/\mu s$
Hold Step Error	$V_{IL} = 0V$ , $V_{IH} = 4.0V$ , $t_R = 5ns$	Full	-10	-	+10	mV
Hold Mode Settling Time	To $\pm 1mV$	+25	-	50	-	ns
Hold Mode Feedthrough	$5V_{P-P}$ , 500kHz, Sine	+25	-	72	-	dB
EADT (Effective Aperture Delay Time)		+25	-	+1	-	ns
Aperture Time (Note 2)		+25	-	10	-	ns
Aperture Uncertainty		+25	-	10	20	ps
<b>POWER SUPPLY CHARACTERISTICS</b>						
Positive Supply Current		Full	-	20	22	mA
Negative Supply Current		Full	-	20	22	mA
PSRR	10% Delta	Full	60	74	-	dB

**NOTES:**

- Derived from Computer Simulation only, not tested.
- +CMRR is measured from 0V to +2.5V, -CMRR is measured from 0V to -2.5V.

Typical Performance Curves

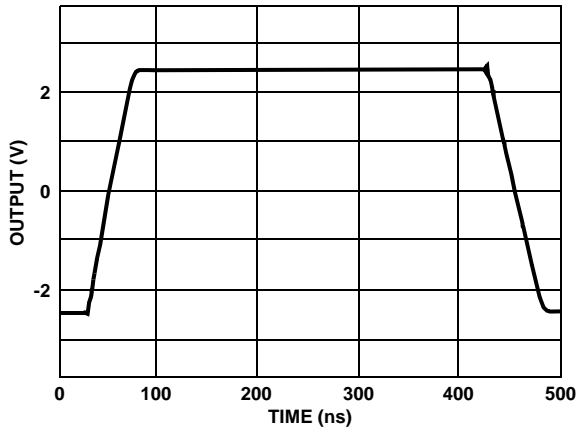

FIGURE 1. LARGE SIGNAL RESPONSE

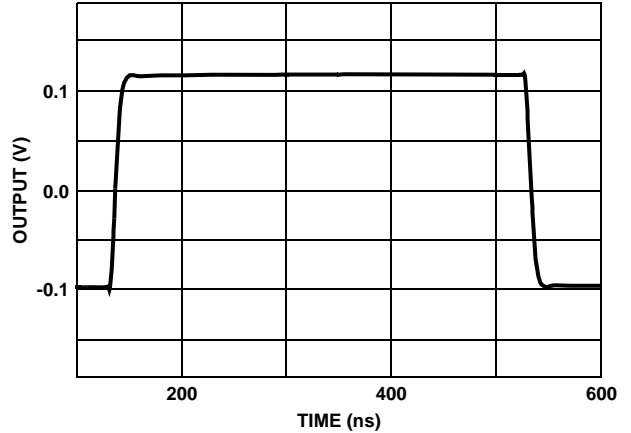

FIGURE 2. SMALL SIGNAL RESPONSE

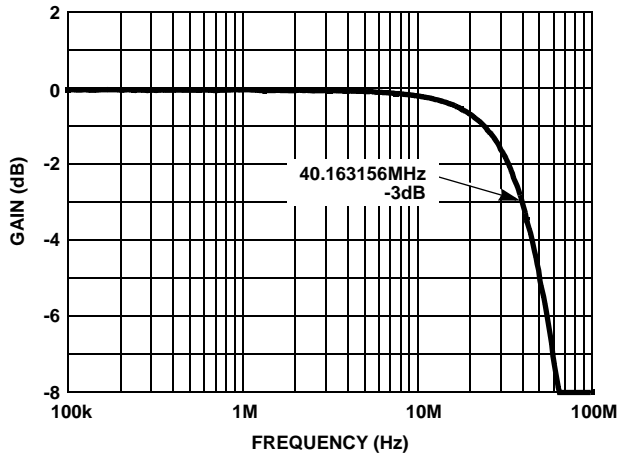

FIGURE 3. UNITY GAIN FREQUENCY RESPONSE

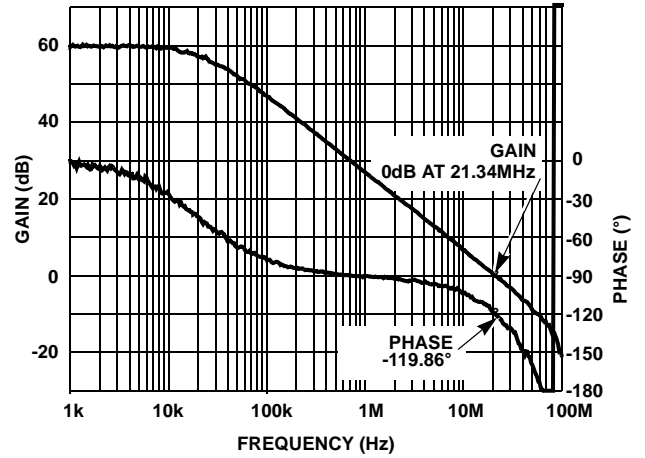

FIGURE 4. CLOSED LOOP GAIN/PHASE  $A_V = +1000$

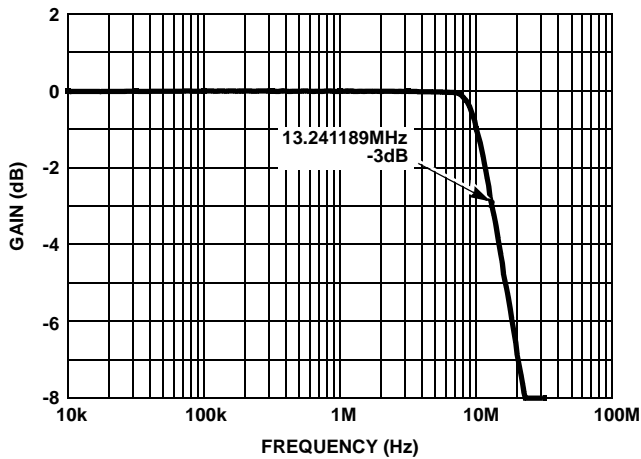

FIGURE 5. 5V<sub>p-p</sub> FULL POWER FREQUENCY RESPONSE

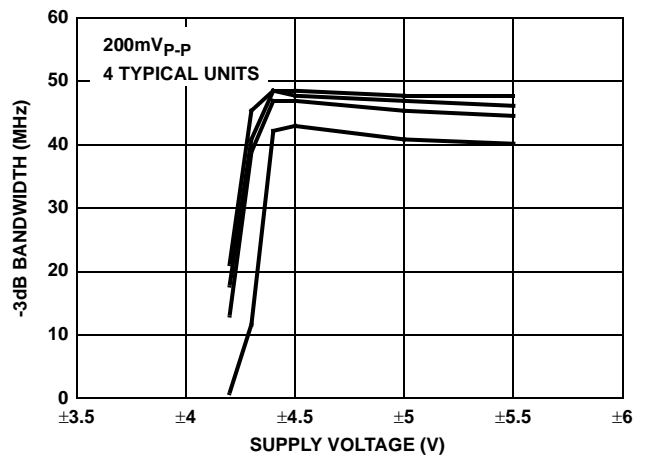

FIGURE 6. -3dB BANDWIDTH vs SUPPLY VOLTAGE

Typical Performance Curves (Continued)

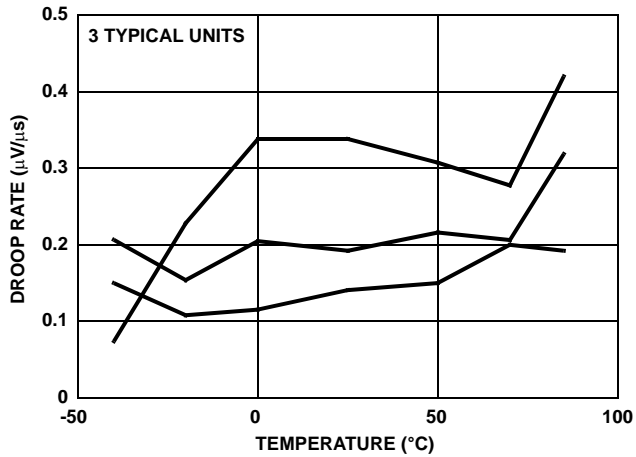

FIGURE 7. DROOP RATE vs TEMPERATURE

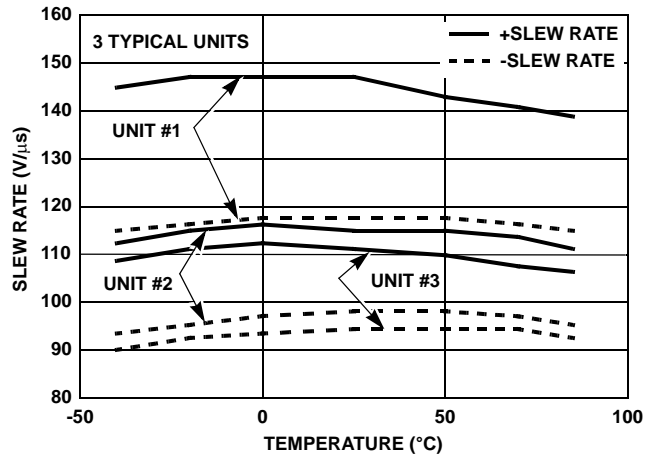

FIGURE 8. SLEW RATE vs TEMPERATURE

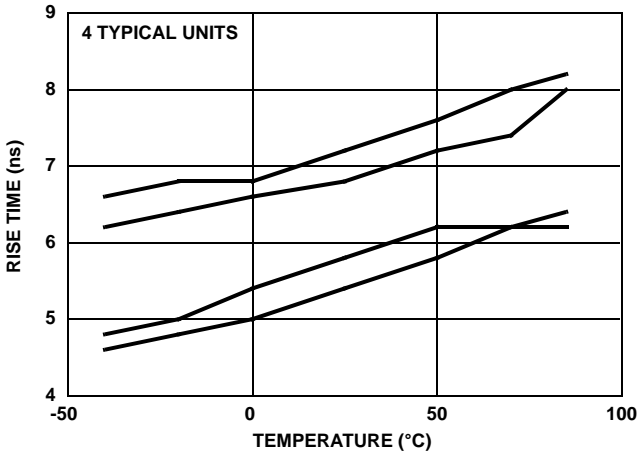

FIGURE 9. RISE TIME vs TEMPERATURE

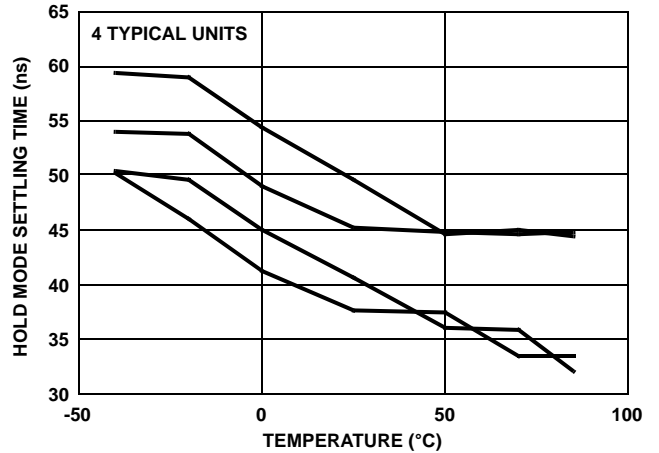

FIGURE 10. HOLD MODE SETTLING vs TEMPERATURE

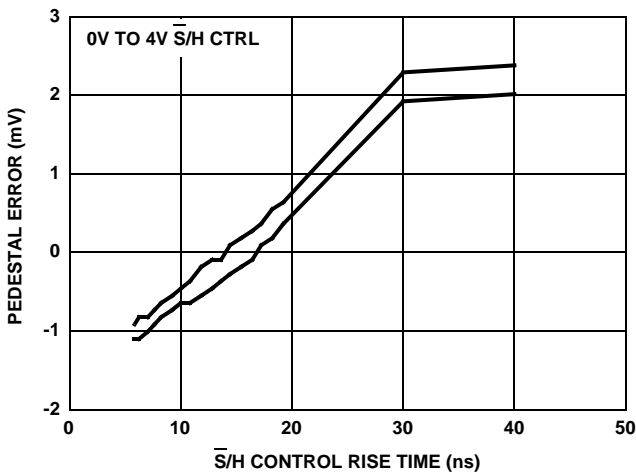

FIGURE 11. PEDESTAL vs S/H CONTROL RISE TIME

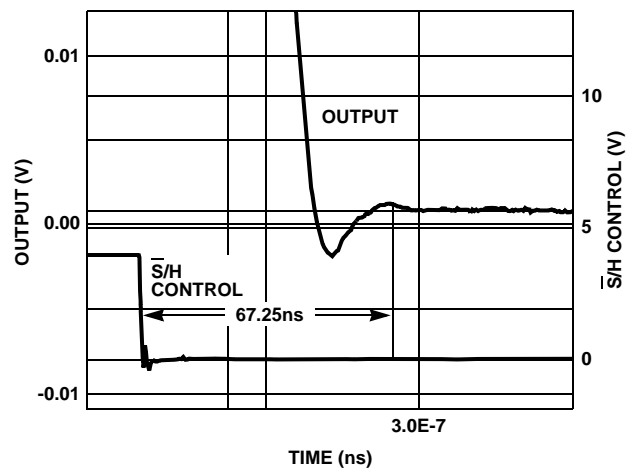

FIGURE 12. ACQUISITION TIME (0.01%, 0V TO 2V STEP)

Typical Performance Curves (Continued)

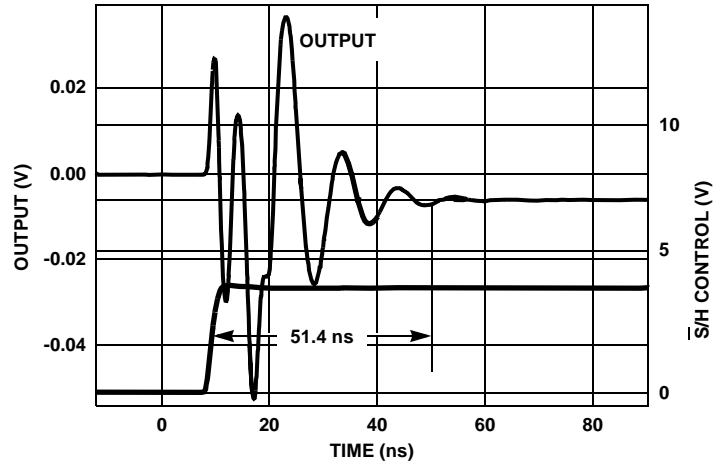

FIGURE 13. HOLD MODE SETTLING TIME ( $\pm 200\mu\text{V}$ )

Die Characteristics

TRANSISTOR COUNT:

SUBSTRATE POTENTIAL:

156

V-

Metallization Mask Layout

HA5351

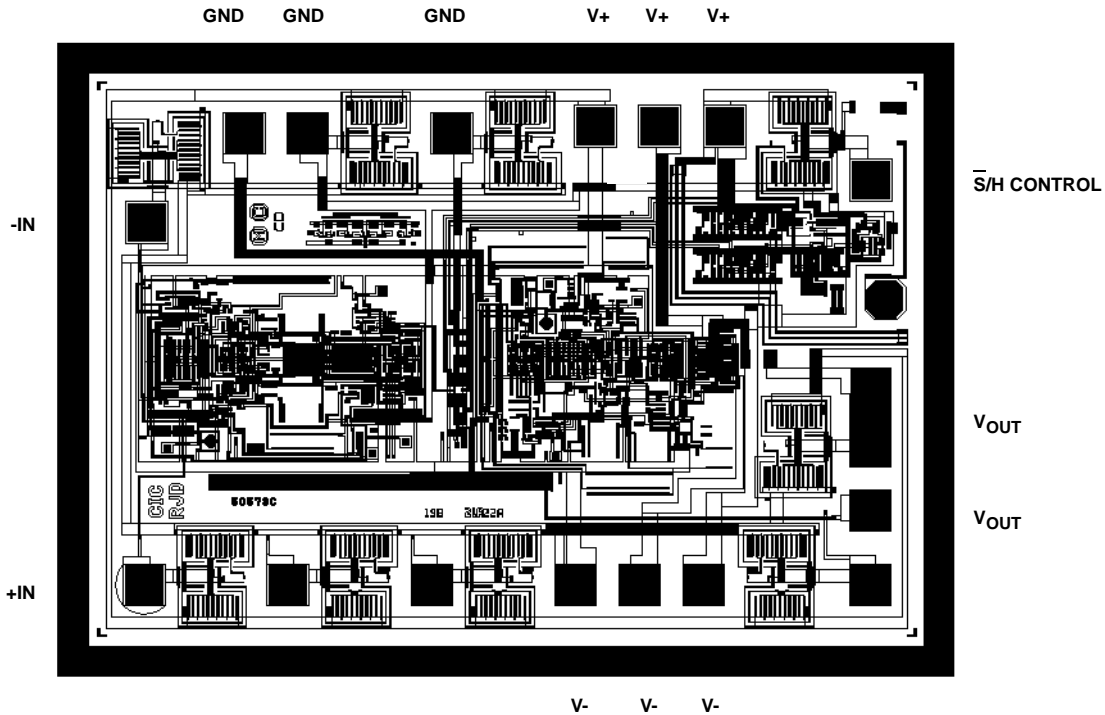

For additional products, see [www.intersil.com/en/products.html](http://www.intersil.com/en/products.html)

Intersil products are manufactured, assembled and tested utilizing ISO9000 quality systems as noted in the quality certifications found at [www.intersil.com/en/support/qualandreliability.html](http://www.intersil.com/en/support/qualandreliability.html)

Intersil products are sold by description only. Intersil Corporation reserves the right to make changes in circuit design, software and/or specifications at any time without notice. Accordingly, the reader is cautioned to verify that data sheets are current before placing orders. Information furnished by Intersil is believed to be accurate and reliable. However, no responsibility is assumed by Intersil or its subsidiaries for its use; nor for any infringements of patents or other rights of third parties which may result from its use. No license is granted by implication or otherwise under any patent or patent rights of Intersil or its subsidiaries.

For information regarding Intersil Corporation and its products, see [www.intersil.com](http://www.intersil.com)

# Package Outline Drawing

## M8.15

8 LEAD NARROW BODY SMALL OUTLINE PLASTIC PACKAGE

Rev 4, 1/12

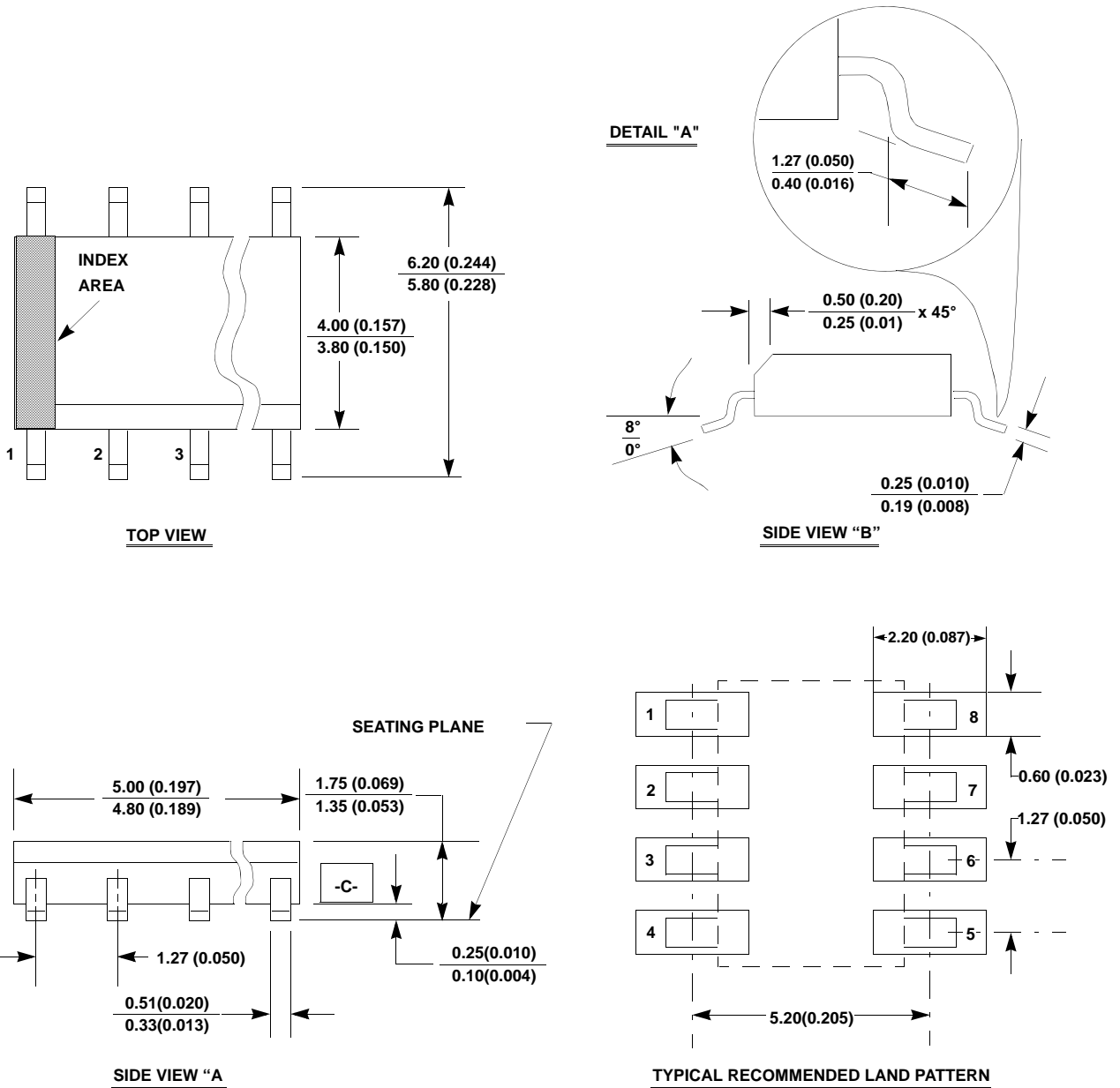

**NOTES:**

1. Dimensioning and tolerancing per ANSI Y14.5M-1994.
2. Package length does not include mold flash, protrusions or gate burrs. Mold flash, protrusion and gate burrs shall not exceed 0.15mm (0.006 inch) per side.
3. Package width does not include interlead flash or protrusions. Interlead flash and protrusions shall not exceed 0.25mm (0.010 inch) per side.
4. The chamfer on the body is optional. If it is not present, a visual index feature must be located within the crosshatched area.
5. Terminal numbers are shown for reference only.
6. The lead width as measured 0.36mm (0.014 inch) or greater above the seating plane, shall not exceed a maximum value of 0.61mm (0.024 inch).
7. Controlling dimension: MILLIMETER. Converted inch dimensions are not necessarily exact.
8. This outline conforms to JEDEC publication MS-012-AA ISSUE C.