

# LNE

## LNE LED Driver

36V 95.4W 1 Phase / LNE-36V100WACA

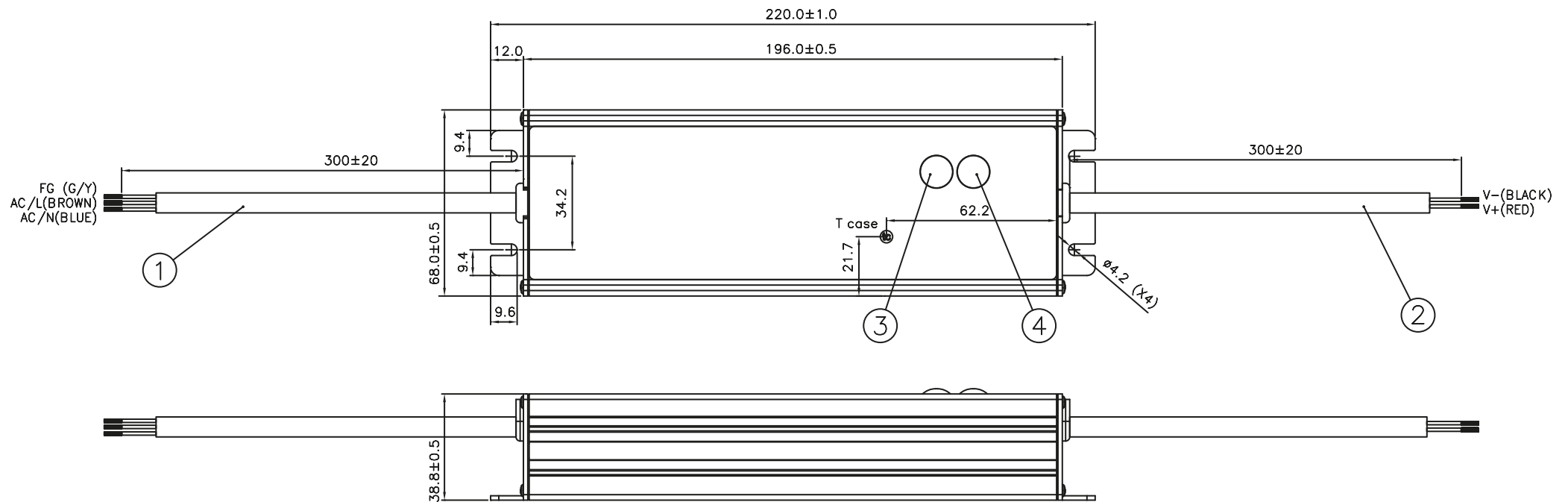

Item	Device Description
1	Input Cable
2	Output Cable
3	Vo Adjust (Constant Voltage Adjustment)
4	Io Adjust (Constant Current Adjustment)
tc	T case (tc): Temperature hot spot location on case.

# LNE

## LNE LED Driver

36V 95.4W 1 Phase / LNE-36V100WAAA

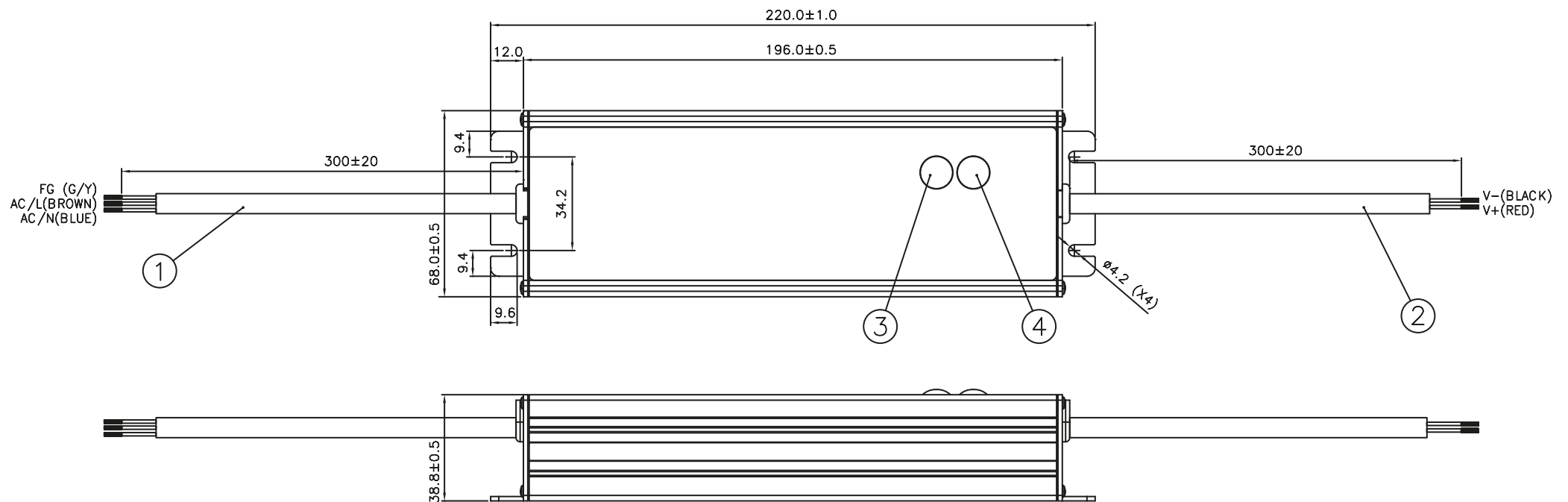

Item	Device Description
1	Input Cable
2	Output Cable
3	Vo Adjust (Constant Voltage Adjustment)
4	Io Adjust (Constant Current Adjustment)

# LNE

## LNE LED Driver

36V 95.4W 1 Phase / LNE-36V100WDCA

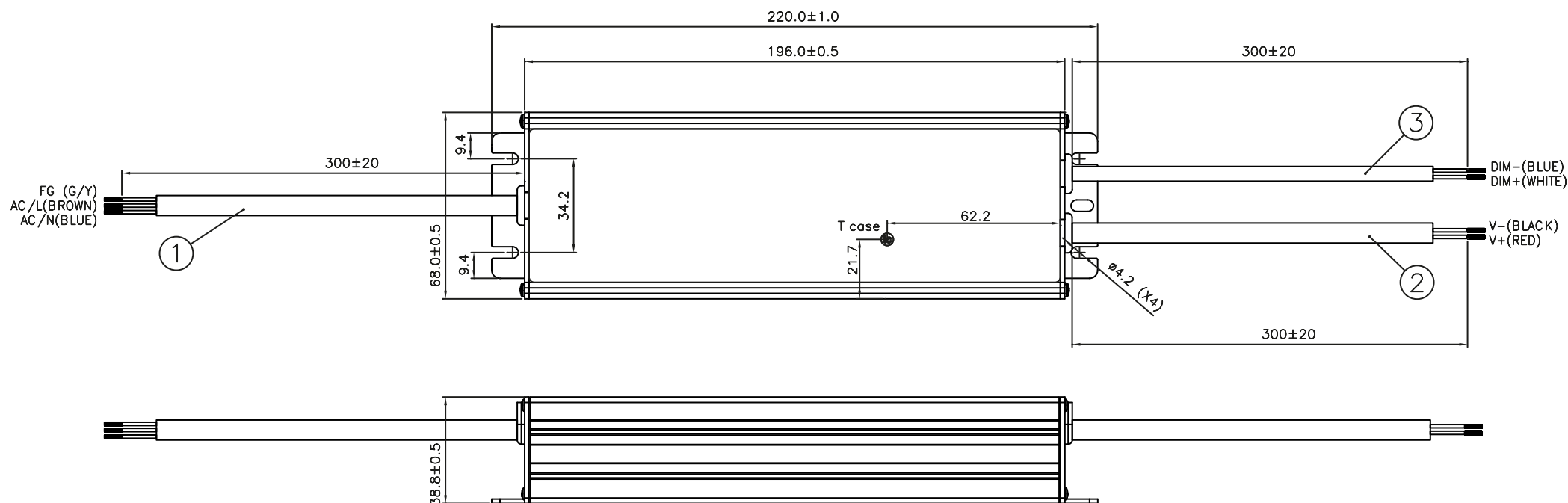

Item	Device Description
1	Input Cable
2	Output Cable
3	Dimming Cable
tc	T case (tc): Temperature hot spot location on case.

# LNE

## LNE LED Driver

36V 95.4W 1 Phase / LNE-36V100WDAA

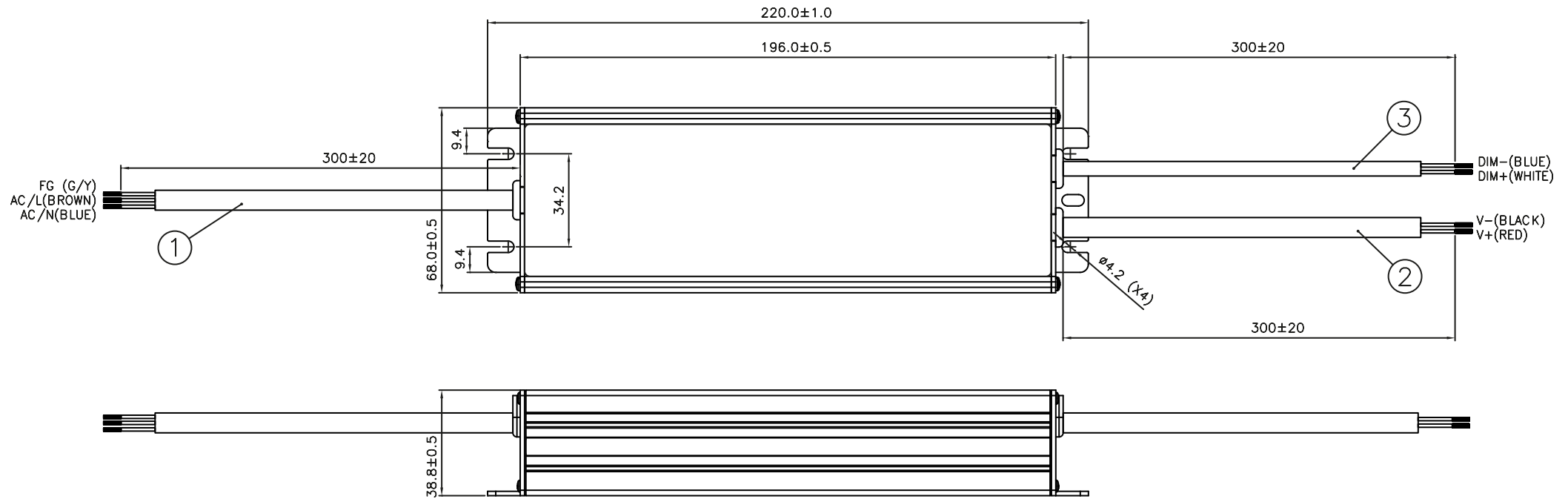

Item	Device Description
1	Input Cable
2	Output Cable
3	Dimming Cable