

THIS DRAWING IS UNPUBLISHED. RELEASED FOR PUBLICATION 20
 © COPYRIGHT 2012 ALL RIGHTS RESERVED.

LOC	DIST	REVISIONS					
		P	LTR	DESCRIPTION	DATE	DWN	APVD
J	-	A		RELEASED FOR PRODUCTION	07MAR2016	TX	SH

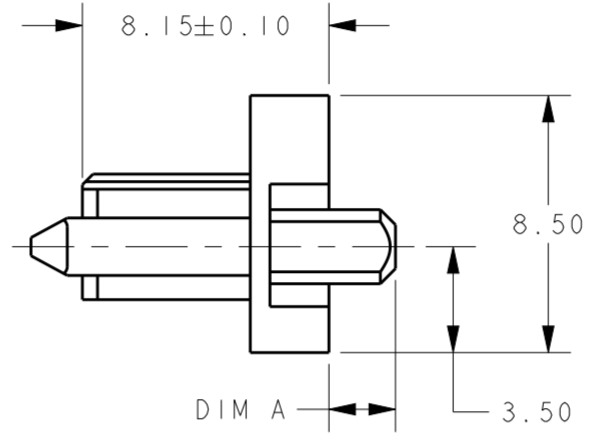

- NOTES:
- MATERIAL:
HOUSING: HIGH TEMP THERMOPLASTIC, UL94V-0,
COLOR: BLACK
CONTACT: COPPER ALLOY
BOARDLOCK: COPPER ALLOY
 - FINISH:
CONTACT AREA: MIN 0.76um GOLD PLATING
SOLDERTAIL: MIN 2.54um MATTE TIN PLATING
UNDERPLATE: MIN 1.27um NICKEL PLATING
 - PIN PIN #P4 AND PIN #P12 ONLY
 - SOLDERTAIL TO BE WITHIN 0.05MAX ABOVE AND 0.10MAX BELOW DATUM E
 - 1.33 MAX MEASURED AT DATUM X
 - PACKAGING: TAPE AND REEL

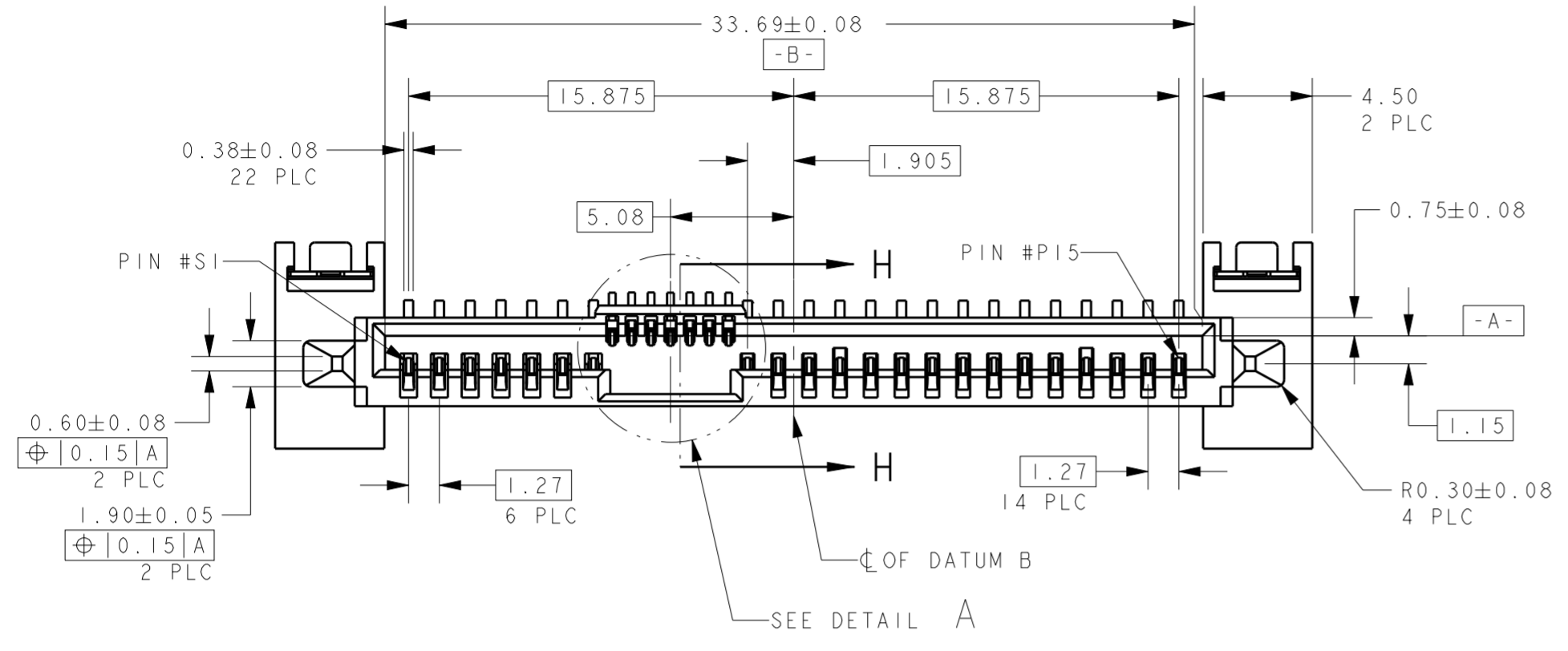
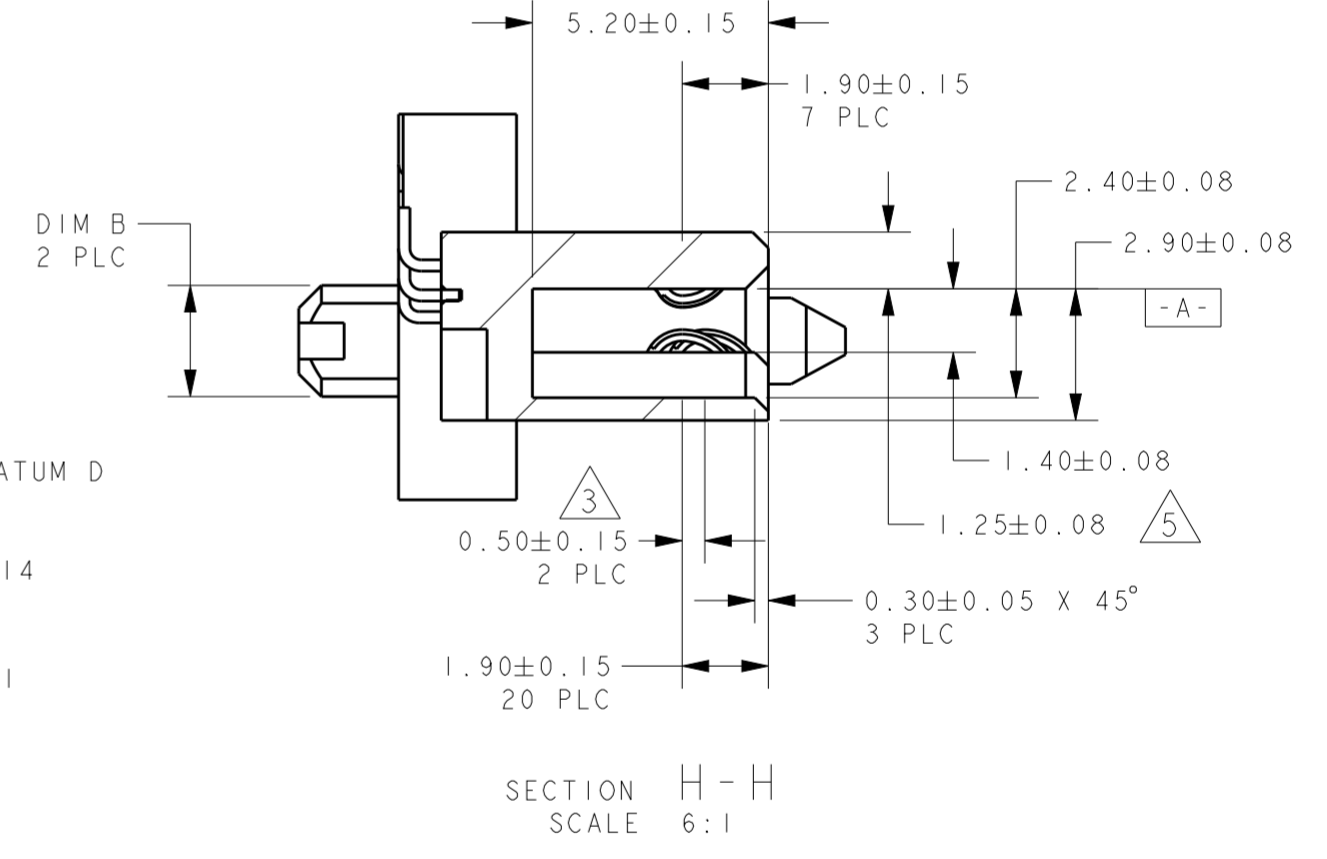
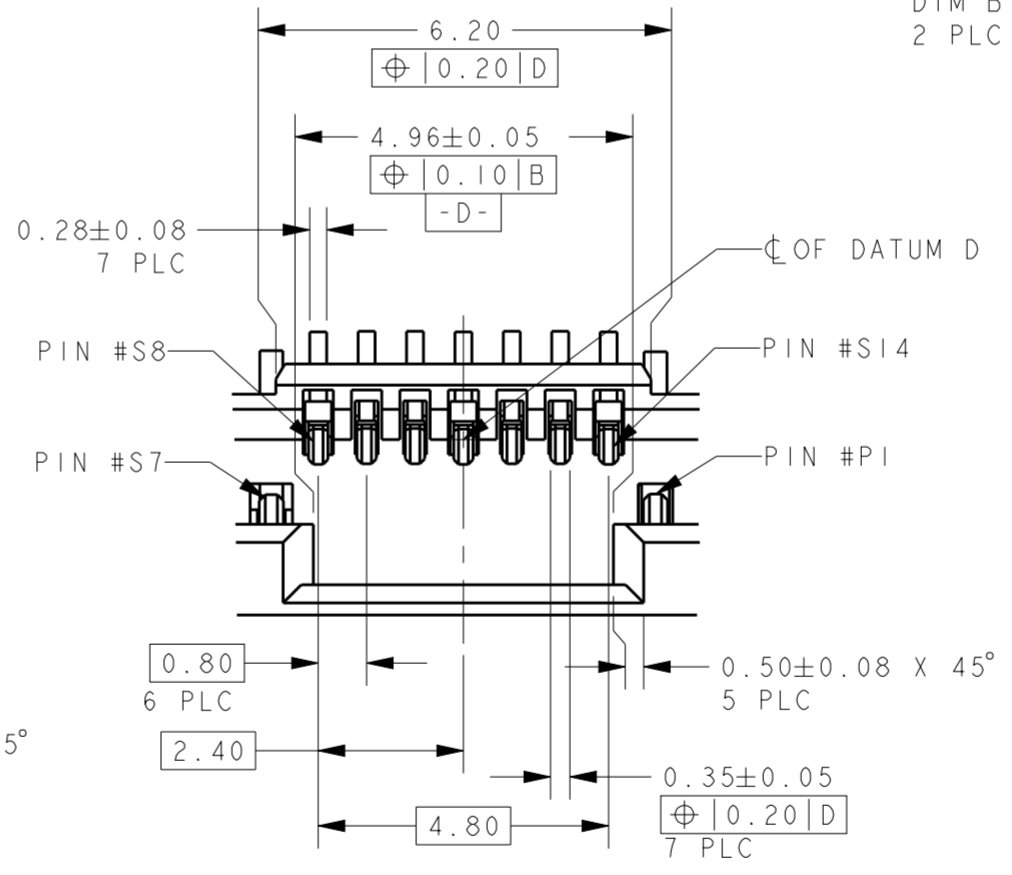
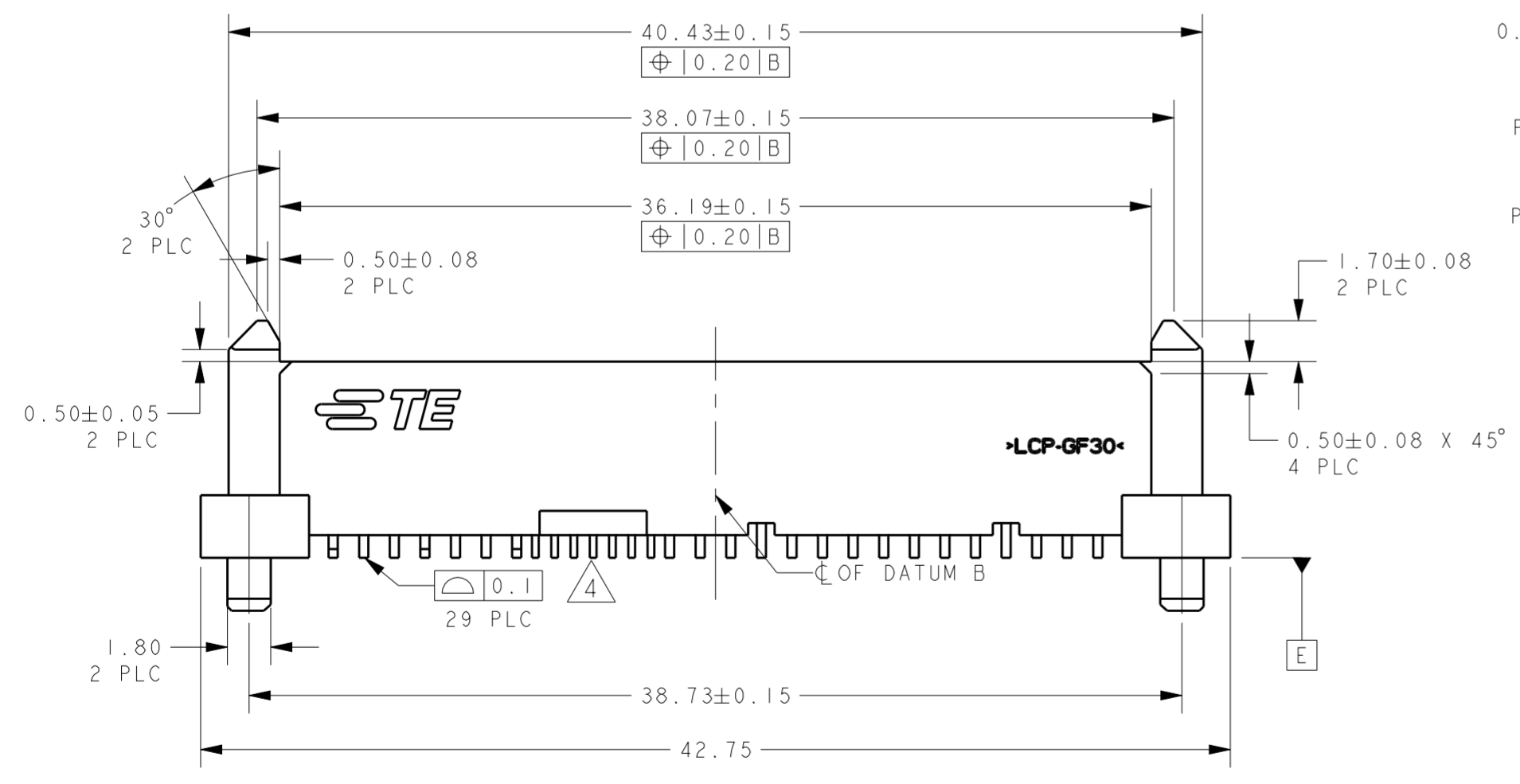

DIM C	DIM B	DIM A	DESCRIPTION	PART NUMBER
Ø1.40	Ø1.26	1.00	WITH PICK-UP CAP	2170563-3
Ø2.50	Ø2.45	2.20	WITHOUT PICK-UP CAP	2170563-2
Ø2.50	Ø2.45	2.20	WITH PICK-UP CAP	2170563-1

THIS DRAWING IS A CONTROLLED DOCUMENT.

DIMENSIONS:	TOLERANCES UNLESS OTHERWISE SPECIFIED:	DWN	26 JUL 2013
mm	0 PLC ±	CHK	26 JUL 2013
	1 PLC ±0.20	APVD	26 JUL 2013
	2 PLC ±0.20	NAME	TIM XUE
	3 PLC ±0.20	PRODUCT SPEC	ALEX CAI
	4 PLC ±	APPLICATION SPEC	ALEX CAI
MATERIAL	ANGLES ±3°	114-60017	
	FINISH	WEIGHT	

STE TE Connectivity

126 SAS RECEPTACLE
DUALLINK, WITH BOARDLOCK
1-SIDED, 15P+7P+7P

SIZE: A2 CAGE CODE: 2170563 DRAWING NO: 108-51109 RESTRICTED TO: -

CUSTOMER DRAWING SCALE: 2:1 SHEET 1 OF 2 REV A

THIS DRAWING IS UNPUBLISHED. RELEASED FOR PUBLICATION 20
 © COPYRIGHT 2012 ALL RIGHTS RESERVED.

LOC	DIST	REVISIONS			
P	LTR	DESCRIPTION	DATE	DWN	APVD
-	-	SEE SHEET 1	-	-	-

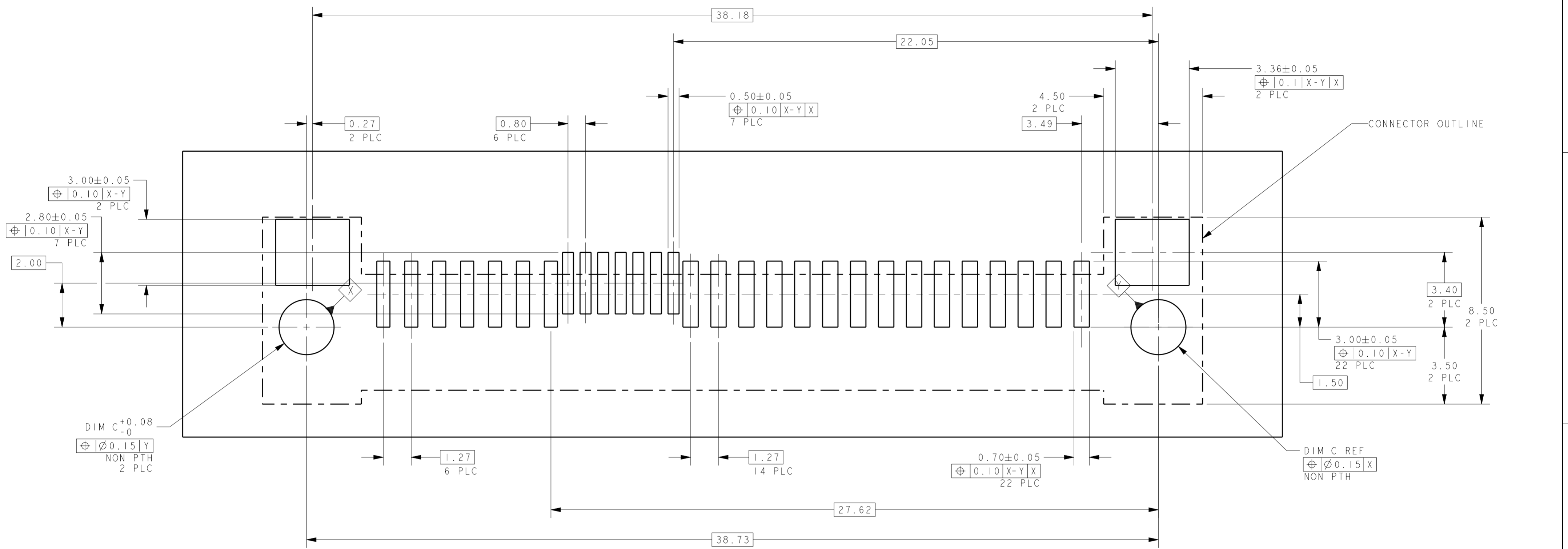

RECOMMENDED RECEPTACLE BOARD LAYOUT
 SCALE 8:1

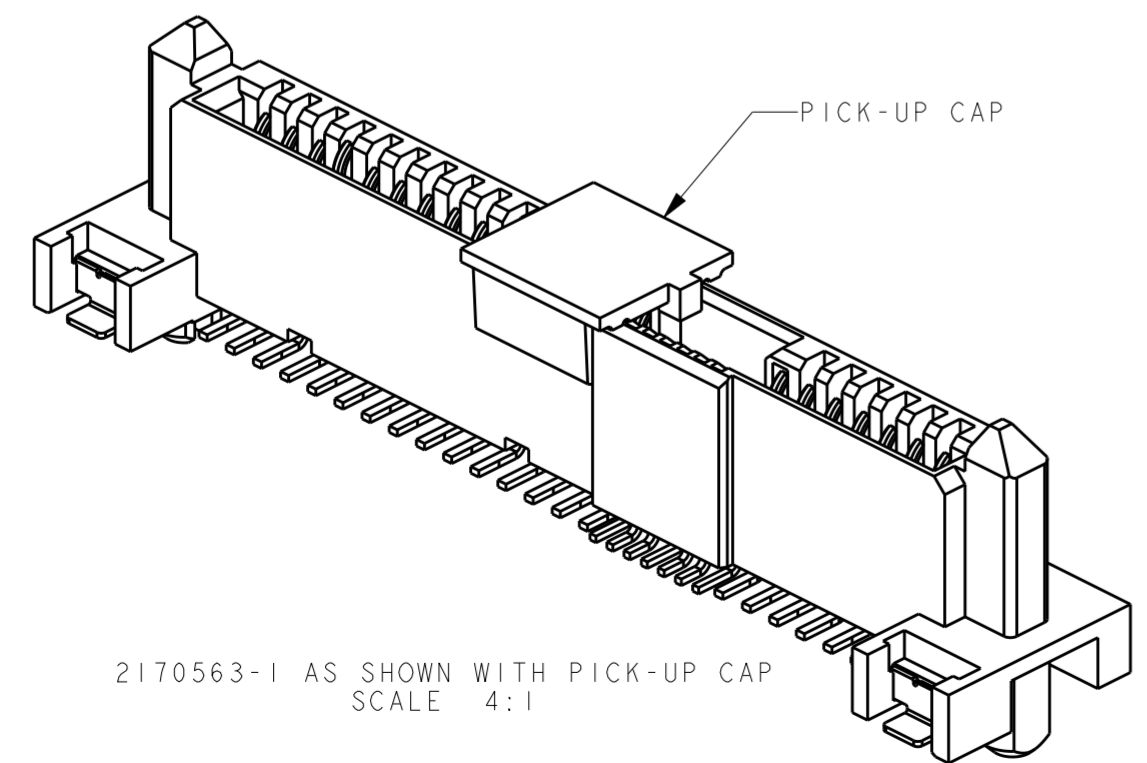

THIS DRAWING IS A CONTROLLED DOCUMENT.		DWN TIM XUE 26 JUL 2013	 TE Connectivity
DIMENSIONS: mm		CHK ALEX CAI 26 JUL 2013	
TOLERANCES UNLESS OTHERWISE SPECIFIED:		APVD ALEX CAI 26 JUL 2013	
0 PLC ± 1 PLC ±0.20 2 PLC ±0.20 3 PLC ±0.20 4 PLC ± ANGLES ±3° FINISH		NAME 12G SAS RECEPTACLE DUALLINK, WITH BOARDLOCK 1-SIDED, 15P+7P+7P PRODUCT SPEC 108-51109 APPLICATION SPEC 114-60017 WEIGHT	
MATERIAL		CUSTOMER DRAWING	SIZE A2 CAGE CODE 0779 DRAWING NO C-2170563 RESTRICTED TO - SCALE 2:1 SHEET 2 OF 2 REV A