

Inductors And Common Mode Chokes

For Use in ADSL POTS Low Pass Filters

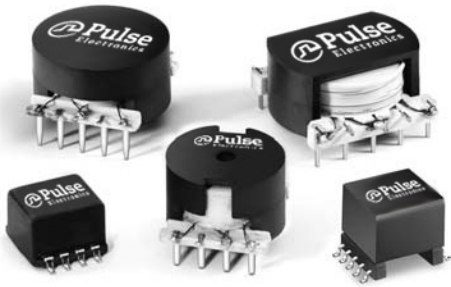

- Excellent longitudinal balance
- Inductors also available in surface mount packages
- Customized inductance values available
- Inductance is stable within $\pm 10\%$ with DC current from 0 to 100mA

Electrical Specifications @ 25°C - Operating Temperature -40°C to +125°C

RoHS-5 Compliant Part No.	RoHS-6 Compliant Part No.	Inductance (each winding) (mH)	DC Resistance (each winding) (Ω MAX)	Isolation Voltage (between windings) (Vrms)	Function	Mounting
B2005	B2005NL	9.0 \pm 30%	0.60	1500	Common Mode Choke	THT
B2013 ³	B20013NL ³	9.0 \pm 30%	1.00	1500	Common Mode Choke	SMT
B2023	-	6.0 \pm 5%	4.00	1500	Coupled Inductor for POTS Low Pass Filter	THT
B2024	-	4.0 \pm 5%	3.00	1500	Coupled Inductor for POTS Low Pass Filter	THT
B2025	-	3.0 \pm 5%	2.50	1500	Coupled Inductor for POTS Low Pass Filter	THT
B2026	-	10.0 \pm 5%	4.50	1500	Coupled Inductor for POTS Low Pass Filter	THT
B2086 ³	B2086NL ³	4.0 \pm 10%	3.60	1250	Coupled Inductor for POTS Low Pass Filter	SMT
B2113	-	2.25 \pm 10%	2.25	500	Coupled Inductor for POTS Low Pass Filter	THT
B2114	-	1.425 \pm 10%	2.25	500	Coupled Inductor for POTS Low Pass Filter	THT
B2116	-	1.65 \pm 10%	2.25	500	Coupled Inductor for POTS Low Pass Filter	THT
B2117	-	1.35 \pm 10%	2.25	500	Coupled Inductor for POTS Low Pass Filter	THT
B2118	-	0.8 \pm 10%	2.00	500	Coupled Inductor for POTS Low Pass Filter	THT
B8098 ³	B8098NL ³	4.0 \pm 10%	3.60	1250	Coupled Inductor for POTS Low Pass Filter	SMT

1. 100kHz, 20mVrms. 2. 1.0kHz, 1.0Vrms, 0 mA (each winding). 3. For Tape & Reel packaging, add the suffix "T" to this part number (B2013T or B2013NLT)

Notes: The B2005 and B2013 are common mode chokes that reduce common mode voltages in the low frequency range that may be caused by telephone ringing signals or by interference from radio transmitters in the ADSL frequency range. The chokes are also designed to accommodate DC currents up to 100mA.

Mechanical

Schematic

B2024 / B2025 / B2113 / B2114 / B2116 / B2117

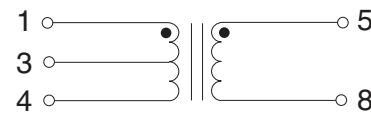
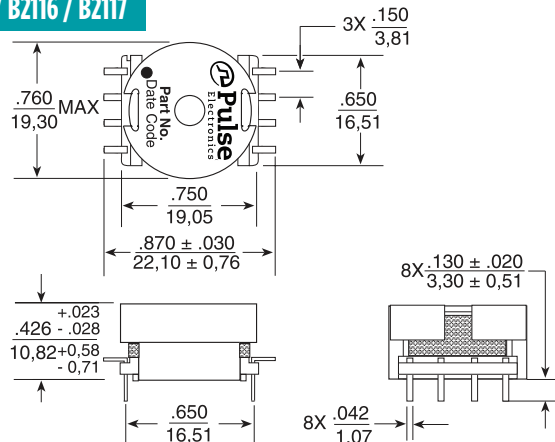

Weight9.5 grams

Tray30/tray

Dimensions: $\frac{\text{Inches}}{\text{mm}}$

Unless otherwise specified, all tolerances are $\pm \frac{.010}{0,25}$

USA 858 674 8100

Germany 49 7032 7806 0

Singapore 65 6287 8998

Shanghai 86 21 62787060

China 86 755 33966678

Taiwan 886 3 4356768

Inductors And Common Mode Chokes

For Use in ADSL POTS Low Pass Filters



Mechanicals

Schematics

B2118

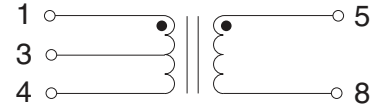
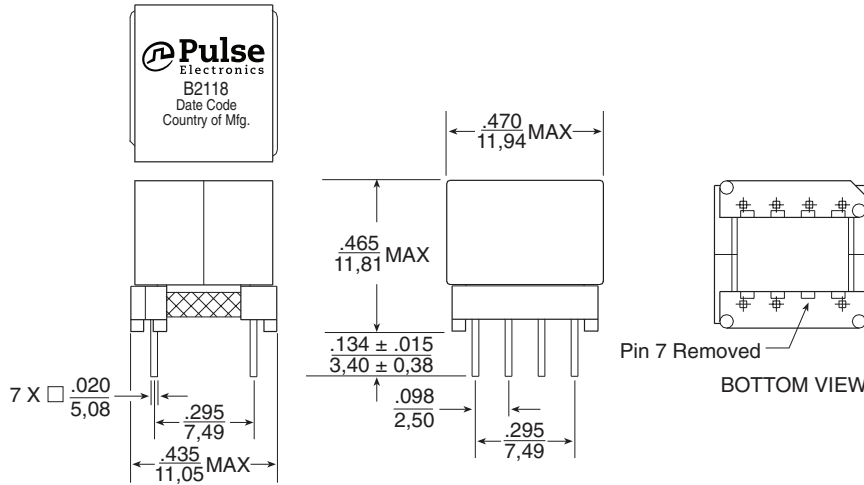

Weight3.6 grams

Tray75/tray

Dimensions: $\frac{\text{Inches}}{\text{mm}}$

Unless otherwise specified,
all tolerances are ± $\frac{.010}{0,25}$

B2023

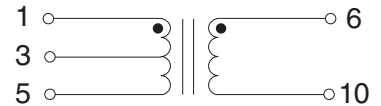
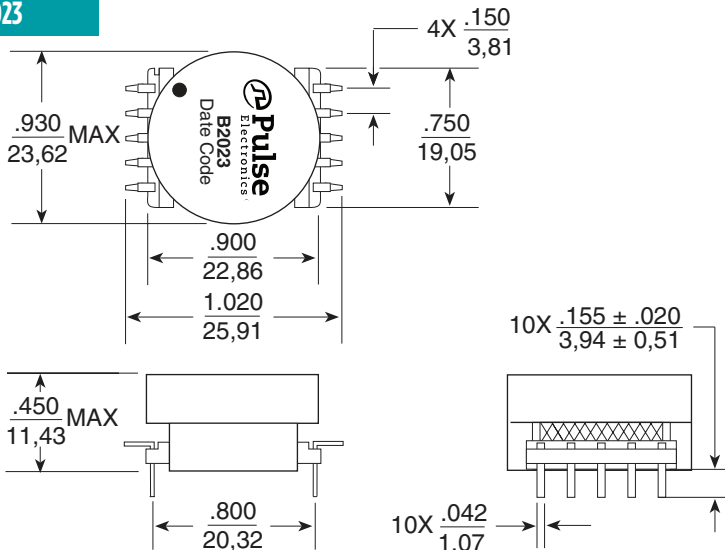

Weight15.0 grams

Tray45/tray

Dimensions: $\frac{\text{Inches}}{\text{mm}}$

Unless otherwise specified,
all tolerances are ± $\frac{.010}{0,25}$

B2026

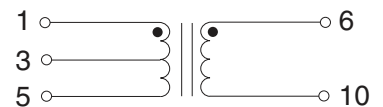
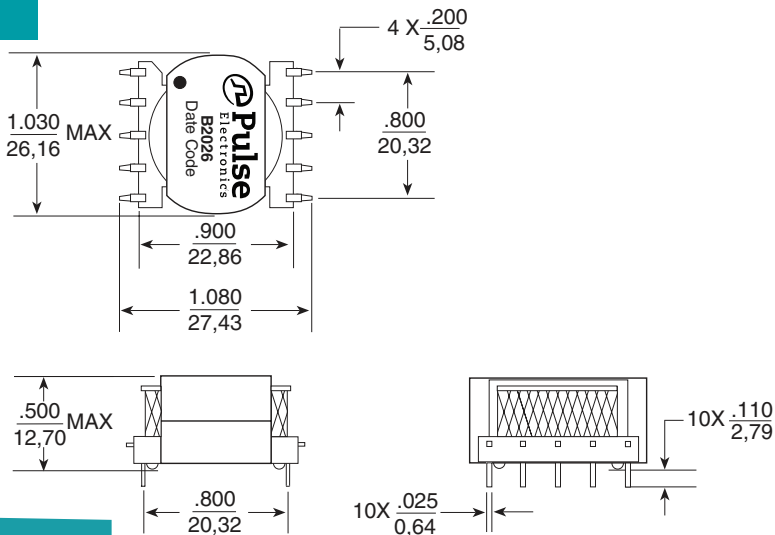

Weight17.5 grams

Tray25/tray

Dimensions: $\frac{\text{Inches}}{\text{mm}}$

Unless otherwise specified,
all tolerances are ± $\frac{.010}{0,25}$

Inductors And Common Mode Chokes

For Use in ADSL POTS Low Pass Filters



Mechanicals

Schematics

B2086 / B2086NL / B8098 / B8098NL

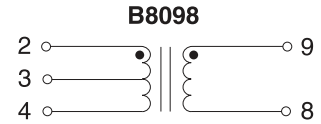
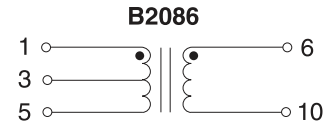
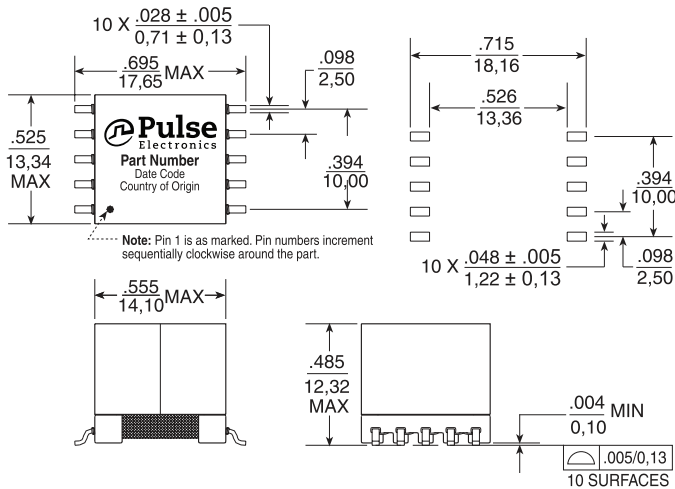

Weight6.2 grams
 Tape & Reel150/reel
 Tray60/tray
 Dimensions: $\frac{\text{Inches}}{\text{mm}}$

Unless otherwise specified,
 all tolerances are $\pm \frac{.010}{0,25}$

B2005 / B2005NL

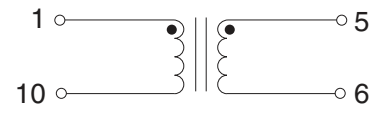
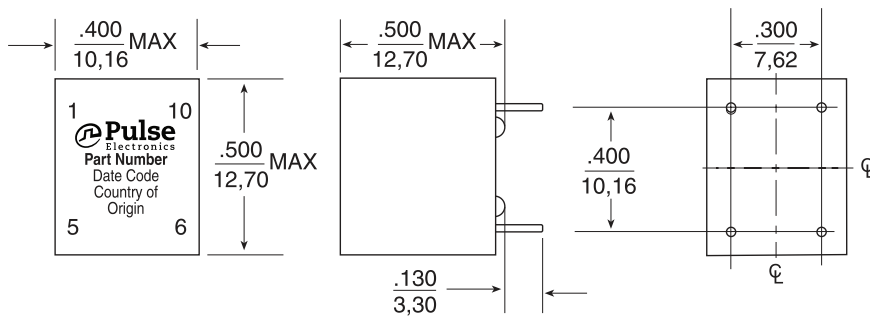

Weight3.7 grams
 Tray40/tray
 Dimensions: $\frac{\text{Inches}}{\text{mm}}$

Unless otherwise specified,
 all tolerances are $\pm \frac{.010}{0,25}$

B2013 / B2013NL

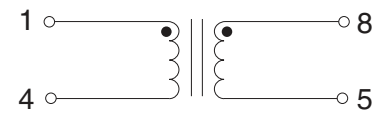
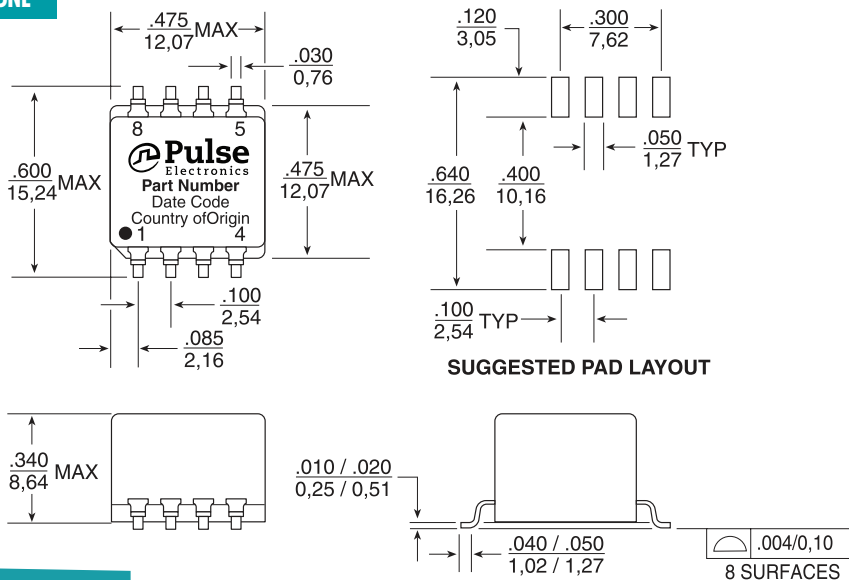

Weight2.5 grams
 Tape & Reel250/reel
 Tray40/tray
 Dimensions: $\frac{\text{Inches}}{\text{mm}}$

Unless otherwise specified,
 all tolerances are $\pm \frac{.010}{0,25}$

Inductors And Common Mode Chokes

For Use in ADSL POTS Low Pass Filters

Performance Description

The series of coupled inductors shown on this data sheet are current and temperature, high self-resonant frequency, low ideal for use in Asymmetrical Digital Subscriber Line (ADSL) applications where a low pass filter is required to separate the voice frequencies from the data frequencies that are carried on an ADSL line. In spite of their small footprint and low profile, these coupled inductors provide excellent electrical performance. They have stable inductance with varying DC current and temperature, high self-resonant frequency, low coupling capacitance, and excellent balance. The common mode chokes were developed to reduce common mode voltages in the low frequency range that is used for voice transmission. The chokes are also designed to accommodate DC currents up to 100 mA.

Application Circuit

The following schematic depicts a typical LC filter that incorporates the use of a common mode choke in addition to the LC network. As shown in the frequency response graph below, at low frequencies, the amplitude of the output signal is roughly equal to the amplitude of the

input signal. At higher frequencies, the amplitude of the output decreases. Thus, the network passes low frequency voice signals with only a small degree of attenuation, while it suppresses high frequency signals and acts as a low pass filter.

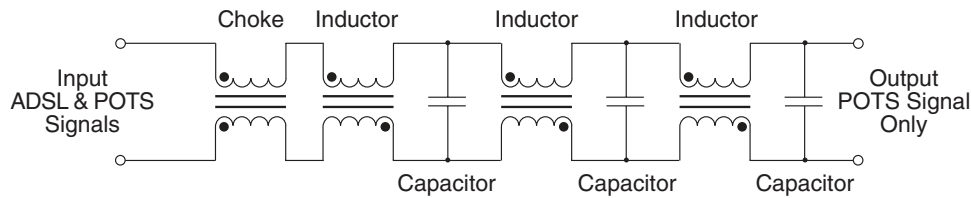

Frequency Response

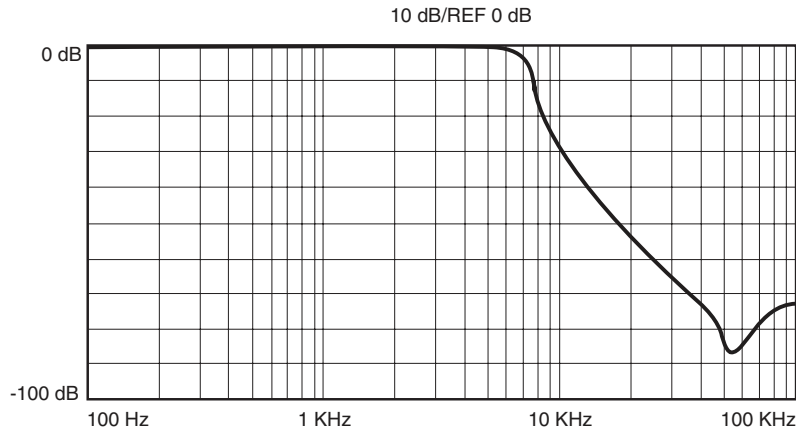

For More Information

Pulse Worldwide Headquarters
12220 World Trade Drive
San Diego, CA
92128
U.S.A.

Tel: 858 674 8100
Fax: 858 674 8262

Pulse Europe
Einsteinstrasse 1
D-71083 Herrenberg
Germany

Tel: 49 7032 78060
Fax: 49 7032 7806 135

Pulse China Headquarters
B402, Shenzhen Academy of
Aerospace Technol-
ogy Bldg.
10th Kejian Road
High-Tech Zone
Nanshan District
Shenzhen, PR China
518057
Tel: 86 755 33966678
Fax: 86 755 33966700

Pulse North China
Room 2704/2705
Super Ocean Finance
Ctr.
2067 Yan An Road
West
Shanghai 200336
China
Tel: 86 21 62787060
Fax: 86 2162786973

Pulse South Asia
135 Joo Seng Road
#03-02
PM Industrial Bldg.
Singapore 368363
Tel: 65 6287 8998
Fax: 65 6287 8998

Pulse North Asia
3F, No. 198
Zhongyuan Road
Zhongli City
Taoyuan County 320
Taiwan R. O. C.
Tel: 886 3 4356768
Fax: 886 3 4356823 (Pulse)
Fax: 886 3 4356820 (FRE)

Performance warranty of products offered on this data sheet is limited to the parameters specified. Data is subject to change without notice. Other brand and product names mentioned herein may be trademarks or registered trademarks of their respective owners. © Copyright, 2012. Pulse Electronics, Inc. All rights reserved.