

IRF7353D1

FETKY™ MOSFET / Schottky Diode

- Co-packaged HEXFET® Power MOSFET and Schottky Diode
- Ideal For Buck Regulator Applications
- N-Channel HEXFET
- Low V_F Schottky Rectifier
- Generation 5 Technology
- SO-8 Footprint

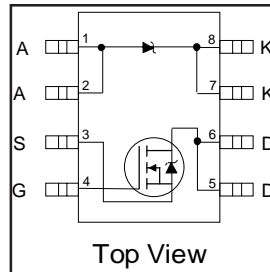

$V_{DSS} = 30V$
$R_{DS(on)} = 0.029\Omega$
Schottky $V_f = 0.39V$

Description

The **FETKY** family of co-packaged MOSFETs and Schottky diodes offers the designer an innovative, board space saving solution for switching regulator and power management applications. Generation 5 HEXFET Power MOSFETs utilize advanced processing techniques to achieve extremely low on-resistance per silicon area. Combining this technology with International Rectifier's low forward drop Schottky rectifiers results in an extremely efficient device suitable for use in a wide variety of portable electronics applications.

The SO-8 has been modified through a customized leadframe for enhanced thermal characteristics. The SO-8 package is designed for vapor phase, infrared or wave soldering techniques.

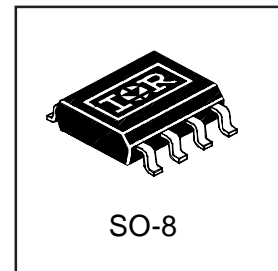

Absolute Maximum Ratings ($T_A = 25^\circ C$ unless otherwise noted)

Parameter		Maximum	Units
$I_D @ T_A = 25^\circ C$	Continuous Drain Current	6.5	A
$I_D @ T_A = 70^\circ C$		5.2	
I_{DM}	Pulsed Drain Current ①	52	
$P_D @ T_A = 25^\circ C$	Power Dissipation	2.0	W
$P_D @ T_A = 70^\circ C$		1.3	
	Linear Derating Factor	16	mW/°C
V_{GS}	Gate-to-Source Voltage	± 20	V
dv/dt	Peak Diode Recovery dv/dt ②	-5.0	V/ns
T_J, T_{STG}	Junction and Storage Temperature Range	-55 to +150	°C

Thermal Resistance Ratings

Parameter		Maximum	Units
$R_{\theta JA}$	Junction-to-Ambient ③	62.5	°C/W

Notes:

- ① Repetitive rating; pulse width limited by maximum junction temperature (see figure 9)
- ② Starting $T_J = 25^\circ C$, $L = 10mH$, $R_G = 25\Omega$, $I_{AS} = 4.0A$
- ③ $I_{SD} \leq 4.0A$, $di/dt \leq 74A/\mu s$, $V_{DD} \leq V_{(BR)DSS}$, $T_J \leq 150^\circ C$
- ④ Surface mounted on FR-4 board, $t \leq 10sec$.

MOSFET Electrical Characteristics @ T_J = 25°C (unless otherwise specified)

Parameter		Min.	Typ.	Max.	Units	Conditions
V _{(BR)DSS}	Drain-to-Source Breakdown Voltage	30	—	—	V	V _{GS} = 0V, I _D = 250μA
R _{DS(on)}	Static Drain-to-Source On-Resistance	—	0.023	0.032	Ω	V _{GS} = 10V, I _D = 5.8A
		—	0.032	0.046		V _{GS} = 4.5V, I _D = 4.7A
V _{GS(th)}	Gate Threshold Voltage	1.0	—	—	V	V _{DS} = V _{GS} , I _D = 250μA
g _{fs}	Forward Transconductance	—	14	—	S	V _{DS} = 24V, I _D = 5.8A
I _{DSS}	Drain-to-Source Leakage Current	—	—	1.0	μA	V _{DS} = 24V, V _{GS} = 0V
		—	—	25		V _{DS} = 24V, V _{GS} = 0V, T _J = 55°C
I _{GSS}	Gate-to-Source Forward Leakage	—	—	100	nA	V _{GS} = 20V
	Gate-to-Source Reverse Leakage	—	—	-100		V _{GS} = -20V
Q _g	Total Gate Charge	—	22	33	nC	I _D = 5.8A
Q _{gs}	Gate-to-Source Charge	—	2.6	3.9		V _{DS} = 24V
Q _{gd}	Gate-to-Drain ("Miller") Charge	—	6.4	9.6		V _{GS} = 10V (see figure 8)
t _{d(on)}	Turn-On Delay Time	—	8.1	12	ns	V _{DD} = 15V
t _r	Rise Time	—	8.9	13		I _D = 1.0A
t _{d(off)}	Turn-Off Delay Time	—	26	39		R _G = 6.0Ω
t _f	Fall Time	—	17	26		R _D = 15Ω
C _{iss}	Input Capacitance	—	650	—	pF	V _{GS} = 0V
C _{oss}	Output Capacitance	—	320	—		V _{DS} = 25V
C _{rss}	Reverse Transfer Capacitance	—	130	—		f = 1.0MHz (see figure 7)

MOSFET Source-Drain Ratings and Characteristics

Parameter		Min.	Typ.	Max.	Units	Conditions
I _S	Continuous Source Current (Body Diode)	—	—	2.5	A	
I _{SM}	Pulsed Source Current (Body Diode)	—	—	30		
V _{SD}	Body Diode Forward Voltage	—	0.78	1.0	V	T _J = 25°C, I _S = 1.7A, V _{GS} = 0V
t _{rr}	Reverse Recovery Time (Body Diode)	—	45	68	ns	T _J = 25°C, I _F = 1.7A
Q _{rr}	Reverse Recovery Charge	—	58	87	nC	di/dt = 100A/μs ^③

Schottky Diode Maximum Ratings

	Parameter	Max.	Units	Conditions	
I _{F(av)}	Max. Average Forward Current	2.7	A	50% Duty Cycle. Rectangular Wave, T _A = 25°C	
		1.9		See Fig. 14 T _A = 70°C	
I _{SM}	Max. peak one cycle Non-repetitive Surge current	120	A	5μs sine or 3μs Rect. pulse	Following any rated load condition & with V _{RRM} applied
		11		10ms sine or 6ms Rect. pulse	

Schottky Diode Electrical Specifications

	Parameter	Max.	Units	Conditions	
V _{FM}	Max. Forward voltage drop	0.50	V	I _F = 1.0A, T _J = 25°C	
		0.62		I _F = 2.0A, T _J = 25°C	
		0.39		I _F = 1.0A, T _J = 125°C	
		0.57		I _F = 2.0A, T _J = 125°C .	
I _{RM}	Max. Reverse Leakage current	0.06	mA	V _R = 30V	T _J = 25°C
		16		T _J = 125°C	
C _t	Max. Junction Capacitance	92	pF	V _R = 5Vdc (100kHz to 1 MHz) 25°C	
dv/dt	Max. Voltage Rate of Charge	3600	V/ μs	Rated V _R	

Power Mosfet Characteristics

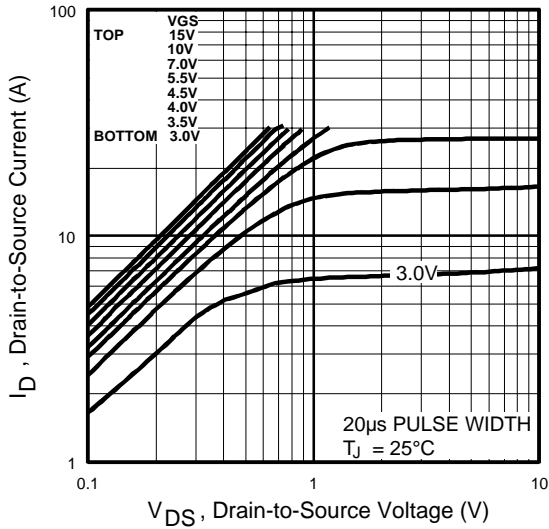

Fig 1. Typical Output Characteristics

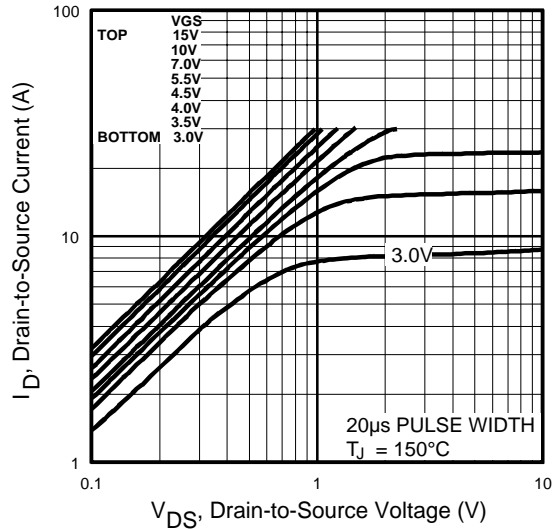

Fig 2. Typical Output Characteristics

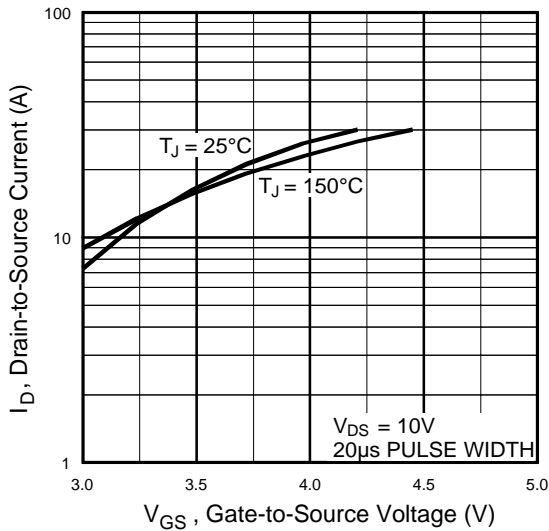

Fig 3. Typical Transfer Characteristics

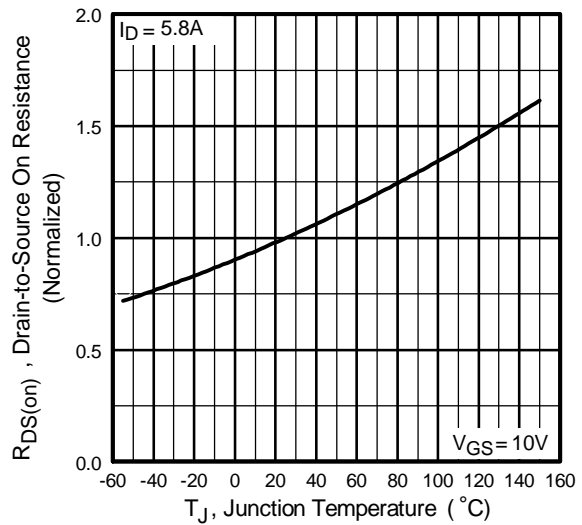

Fig 4. Normalized On-Resistance Vs. Temperature

Power Mosfet Characteristics

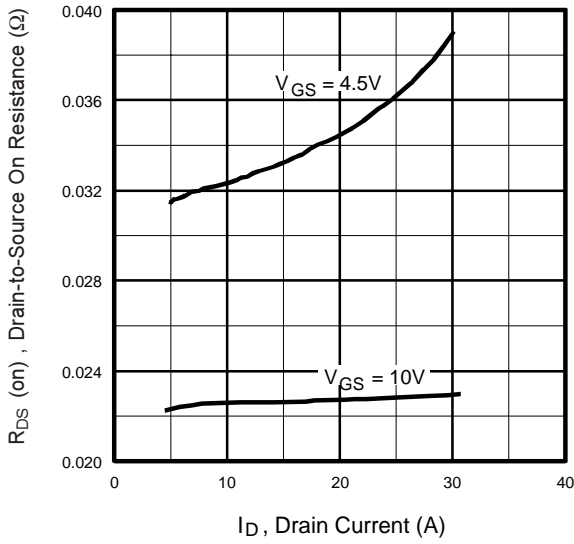

Fig 5. Typical On-Resistance Vs. Drain Current

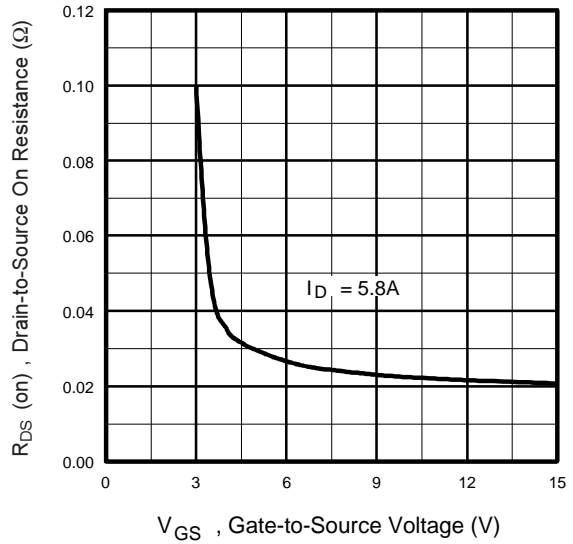

Fig 6. Typical On-Resistance Vs. Gate Voltage

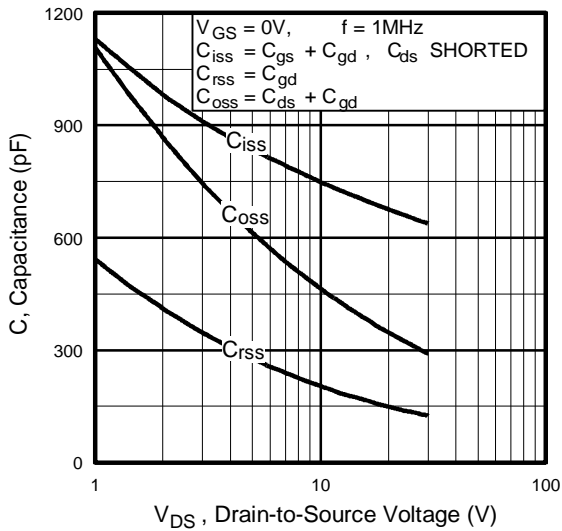

Fig 7. Typical Capacitance Vs. Drain-to-Source Voltage

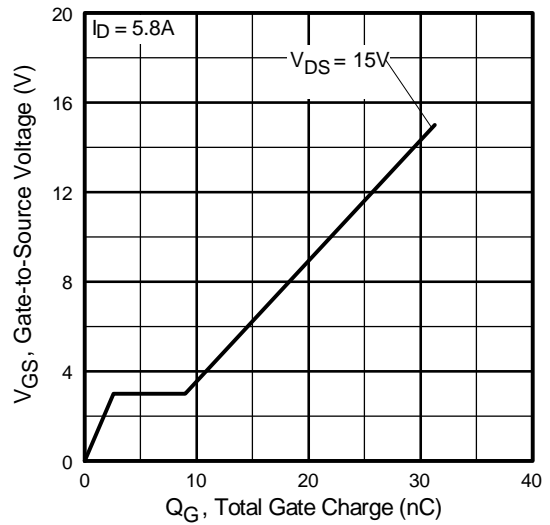

Fig 8. Typical Gate Charge Vs. Gate-to-Source Voltage

Power Mosfet Characteristics

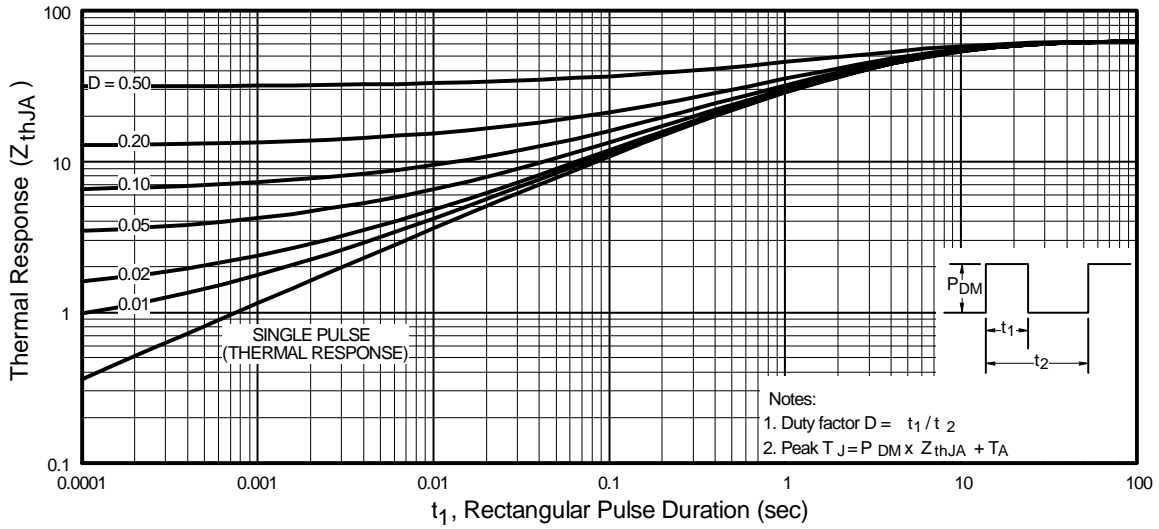

Fig 9. Maximum Effective Transient Thermal Impedance, Junction-to-Ambient

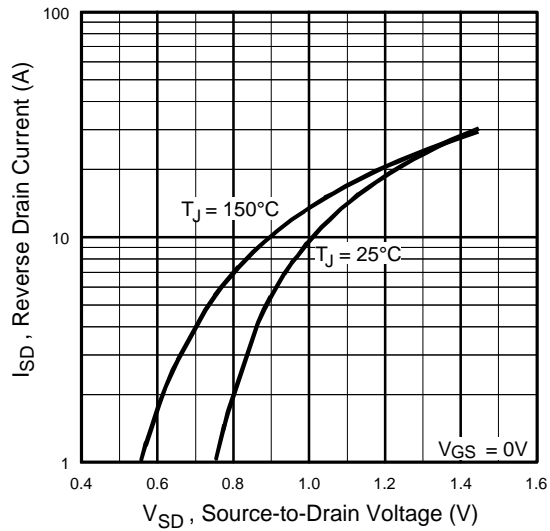

Fig 10. Typical Source-Drain Diode Forward Voltage

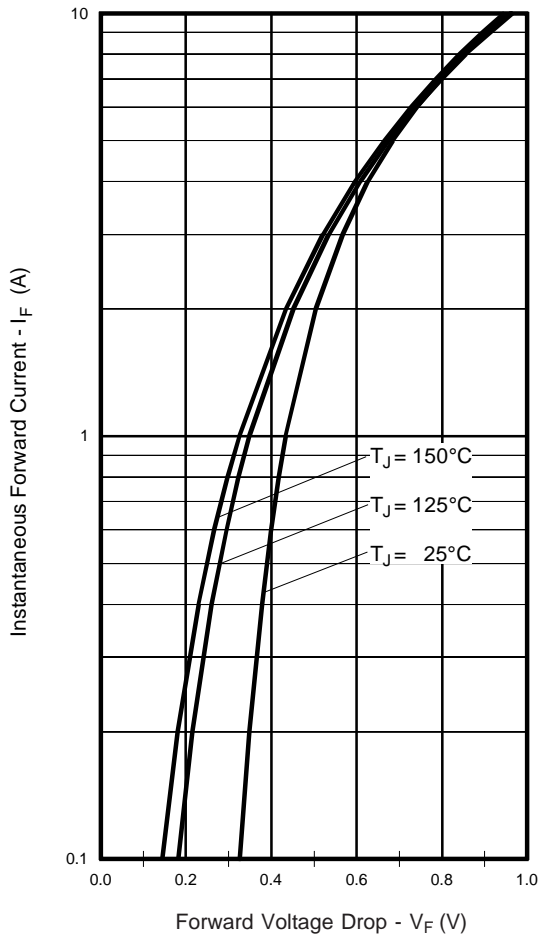

Fig. 12 - Typical Forward Voltage Drop Characteristics

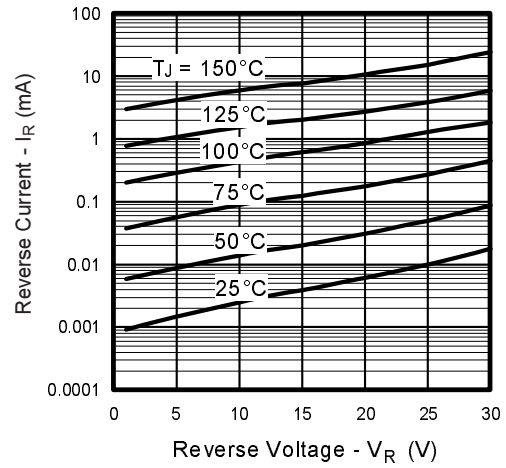

Fig. 13 - Typical Values of Reverse Current Vs. Reverse Voltage

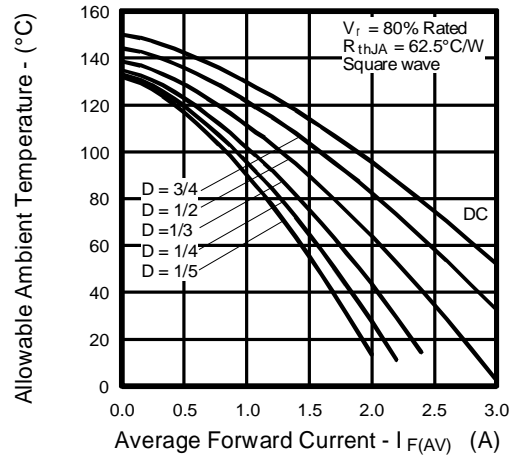
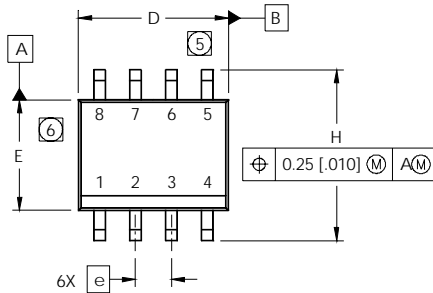

Fig.14 - Maximum Allowable Ambient Temp. Vs. Forward Current

SO-8 (Fetky) Package Outline

Dimensions are shown in millimeters (inches)



DIM	INCHES		MILLIMETERS	
	MIN	MAX	MIN	MAX
A	.0532	.0688	1.35	1.75
A1	.0040	.0098	0.10	0.25
b	.013	.020	0.33	0.51
c	.0075	.0098	0.19	0.25
D	.189	.1968	4.80	5.00
E	.1497	.1574	3.80	4.00
e	.050 BASIC		1.27 BASIC	
e1	.025 BASIC		0.635 BASIC	
H	.2284	.2440	5.80	6.20
K	.0099	.0196	0.25	0.50
L	.016	.050	0.40	1.27
y	0°	8°	0°	8°

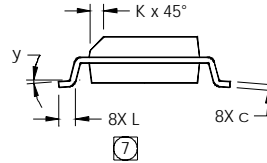
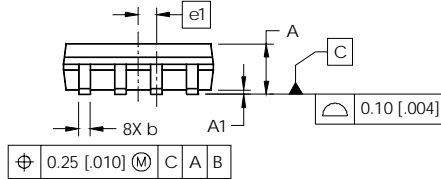

NOTES:

1. DIMENSIONING & TOLERANCING PER ASME Y14.5M-1994.
2. CONTROLLING DIMENSION: MILLIMETER
3. DIMENSIONS ARE SHOWN IN MILLIMETERS [INCHES].
4. OUTLINE CONFORMS TO JEDEC OUTLINE MS-012AA.
5. DIMENSION DOES NOT INCLUDE MOLD PROTRUSIONS. MOLD PROTRUSIONS NOT TO EXCEED 0.15 [0.006].
6. DIMENSION DOES NOT INCLUDE MOLD PROTRUSIONS. MOLD PROTRUSIONS NOT TO EXCEED 0.25 [0.010].
7. DIMENSION IS THE LENGTH OF LEAD FOR SOLDERING TO A SUBSTRATE.

FOOTPRINT

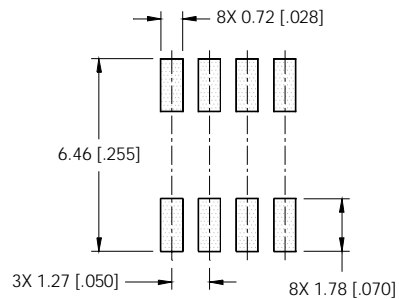

SO-8 (Fetky) Part Marking Information

EXAMPLE: THIS IS AN IRF7807D1 (FETKY)

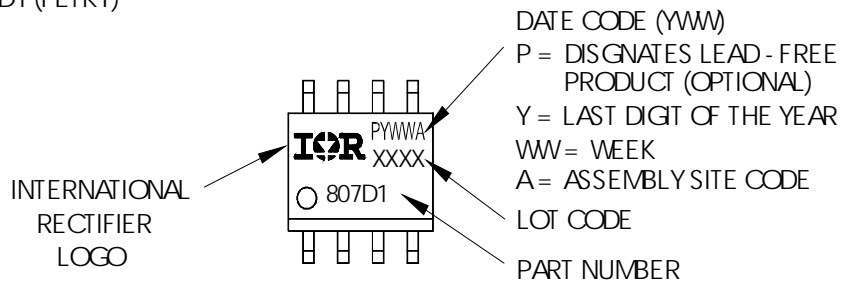

IRF7353D1

SO-8 (Fetky) Tape and Reel

Dimensions are shown in millimeters (inches)

International
IR Rectifier

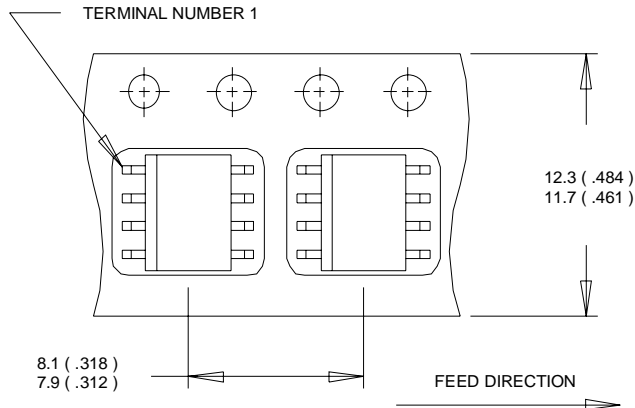

NOTES:

1. CONTROLLING DIMENSION : MILLIMETER.
2. ALL DIMENSIONS ARE SHOWN IN MILLIMETERS(INCHES).
3. OUTLINE CONFORMS TO EIA-481 & EIA-541.

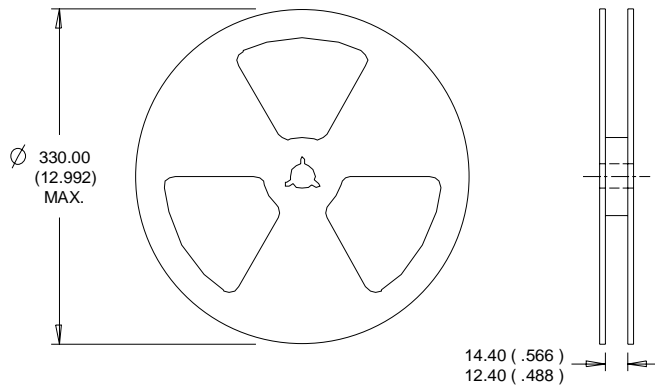

NOTES :

1. CONTROLLING DIMENSION : MILLIMETER.
2. OUTLINE CONFORMS TO EIA-481 & EIA-541.

Data and specifications subject to change without notice.

This product has been designed and qualified for the Consumer market.

Qualification Standards can be found on IR's Web site.

International
IR Rectifier

IR WORLD HEADQUARTERS: 233 Kansas St., El Segundo, California 90245, USA Tel: (310) 252-7105

TAC Fax: (310) 252-7903

Visit us at www.irf.com for sales contact information.10/04

www.irf.com