



ON Semiconductor®

<http://onsemi.com>

# LA4535MC

Monolithic Linear IC

## Power Amplifier for 1.5V Headphone Stereo

### Features

- Low current drain.
- 16Ω load drive capability.
- Excellent reduced voltage characteristics.
- Excellent power supply ripple rejection.
- Minimum number of external parts required (no input capacitor, feedback capacitor required).
- Less harmonic interference in radio band.
- On-chip power switch function, muting function.

### Specifications

#### Absolute Maximum Ratings at Ta = 25°C

Parameter	Symbol	Conditions	Ratings	Unit
Maximum supply voltage	V <sub>CC</sub> max	Quiescent	4.5	V
Allowable power dissipation	P <sub>d</sub> max		290	mW
Operating temperature	T <sub>opr</sub>		-20 to +75	°C
Storage temperature	T <sub>stg</sub>		-40 to +125	°C

Stresses exceeding Maximum Ratings may damage the device. Maximum Ratings are stress ratings only. Functional operation above the Recommended Operating Conditions is not implied. Extended exposure to stresses above the Recommended Operating Conditions may affect device reliability.

#### Operating Conditions at Ta = 25°C

Parameter	Symbol	Conditions	Ratings	Unit
Recommended supply voltage	V <sub>CC</sub>		1.5	V
Operating voltage range	V <sub>CC</sub> op		0.9 to 4.0	V
Recommended load resistance	R <sub>L</sub>		16 to 32	Ω

# LA4535MC

**Electrical Characteristics** at  $T_a = 25^\circ\text{C}$ ,  $R_L = 16\Omega$ ,  $R_g = 600\Omega$ , See specified Test Circuit.

Parameter	Symbol	Conditions	Ratings			Unit
			min	typ	max	
Quiescent current *1	$I_{CCO1}$	$V_{CC} = 1.2\text{V}$ , quiescent		3.5	6.0	mA
	$I_{CCO2}$	$V_{CC} = 2.5\text{V}$ , pin 10 $\rightarrow$ GND		1.5	2.5	mA
	$I_{CCO3}$	$V_{CC} = 2.5\text{V}$ , pin 1 $\rightarrow$ GND			1.0	$\mu\text{A}$
Voltage gain	VG1	$V_{CC} = 1.2\text{V}$ , $f = 1\text{kHz}$ , $V_O = -20\text{dBm}$	20.5	22	23	dB
	VG2	$V_{CC} = 0.9\text{V}$ , $f = 1\text{kHz}$ , $V_O = -20\text{dBm}$	19.5	22	23	dB
Voltage gain difference	$\Delta\text{VG1}$	$V_{CC} = 1.2\text{V}$ , $f = 1\text{kHz}$ , $V_O = -20\text{dBm}$			1.0	dB
	$\Delta\text{VG2}$	$V_{CC} = 0.9\text{V}$ , $f = 1\text{kHz}$ , $V_O = -20\text{dBm}$			1.0	dB
Total harmonic distortion	THD	$V_{CC} = 1.2\text{V}$ , $f = 1\text{kHz}$ , $P_O = 0.5\text{mW}$		0.8	1.5	%
Output power	$P_O$	$V_{CC} = 1.5\text{V}$ , $f = 1\text{kHz}$ , THD = 10%	5	8		mW
Crosstalk	CT	$V_{CC} = 1.2\text{V}$ , $f = 100\text{Hz}$ , $R_g = 1\text{k}\Omega$ , $V_O = -20\text{dB}$	40	45		dB
Ripple rejection	SVRR	$V_{CC} = 1.0\text{V}$ , $f = 100\text{Hz}$ , $R_g = 1\text{k}\Omega$ , $V_R = -30\text{dBm}$ , BPF = 100Hz	45	50		dB
Output noise voltage	$V_{NO}$	$V_{CC} = 2.5\text{V}$ , $R_g = 1\text{k}\Omega$ , BPF = 20Hz to 20kHz		30	44	$\mu\text{V}$
Power off effect	$V_{O(\text{off})}$	$V_{CC} = 0.9\text{V}$ , $f = 100\text{Hz}$ , pin 1 $\rightarrow$ GND, $V_{IN} = -10\text{dB}$			-80	dBm
Muting effect	$V_{O(\text{MT})}$	$V_{CC} = 0.9\text{V}$ , $f = 100\text{Hz}$ , pin 10 $\rightarrow$ GND, $V_{IN} = -10\text{dB}$			-80	dBm
Power on current sensitivity	$I_1(\text{on})$	$V_{CC} = 0.85\text{V}$ , $V_5 \geq 0.5\text{V}$		0.1	1.0	$\mu\text{A}$
Power off voltage sensitivity	$V_1(\text{off})$	$V_{CC} = 0.85\text{V}$ , $V_5 \leq 0.1\text{V}$	0.5	0.65		V
Muting off current sensitivity	$I_{10}(\text{off})$	$V_{CC} = 0.85\text{V}$ , $V_5 \geq 0.5\text{V}$		0.3	1.0	$\mu\text{A}$
Muting on voltage sensitivity	$V_{10}(\text{on})$	$V_{CC} = 0.85\text{V}$ , $V_5 \leq 0.1\text{V}$	0.5	0.65		V

Note) The quiescent current is represented by the current flowing into pin 6. The respective maximum currents flowing into pin 1 and pin 10 are calculated by  $(V_{\text{pin } -0.5} / 16 [V / \text{k}\Omega])$  and the total current increases by these current values.

## Package Dimensions

unit : mm (typ)

3426

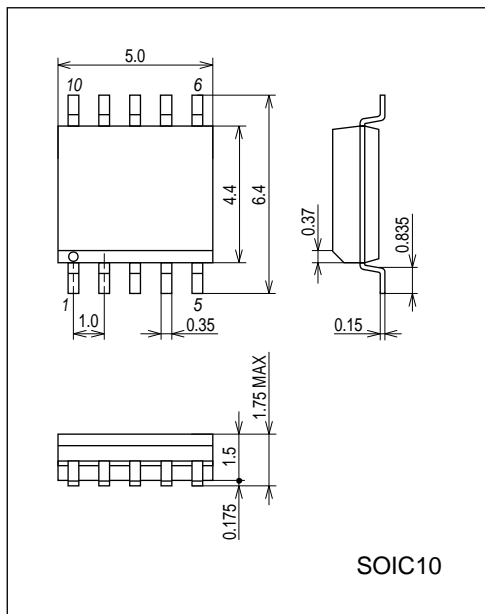

# LA4535MC

## Block Diagram

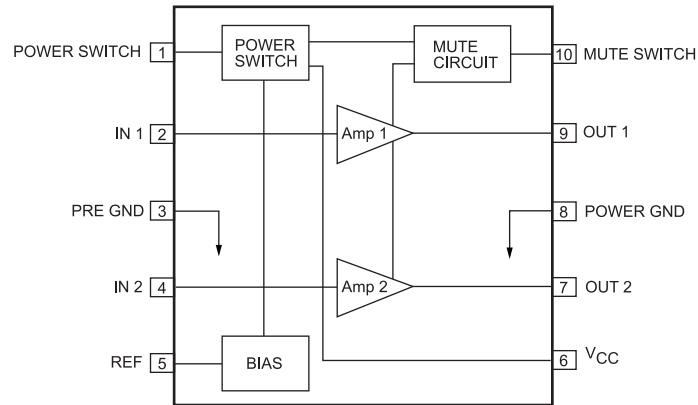

## Test Circuit

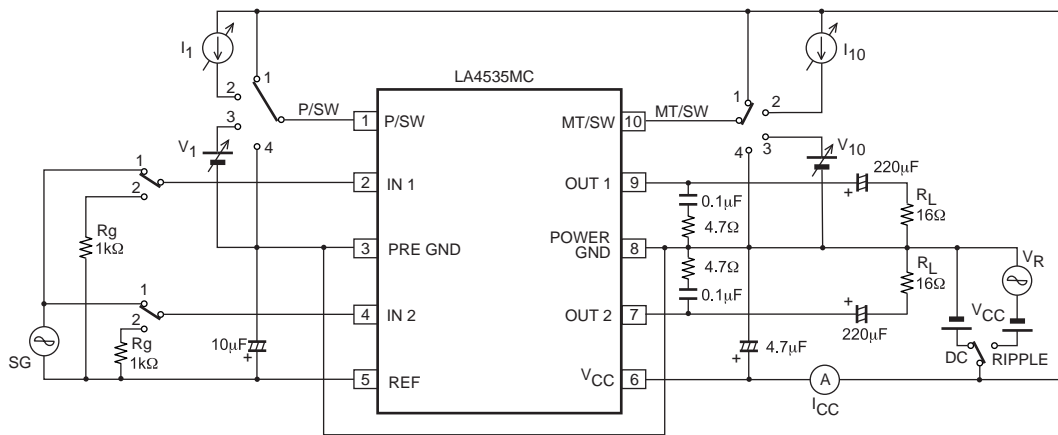

## Sample Application Circuit

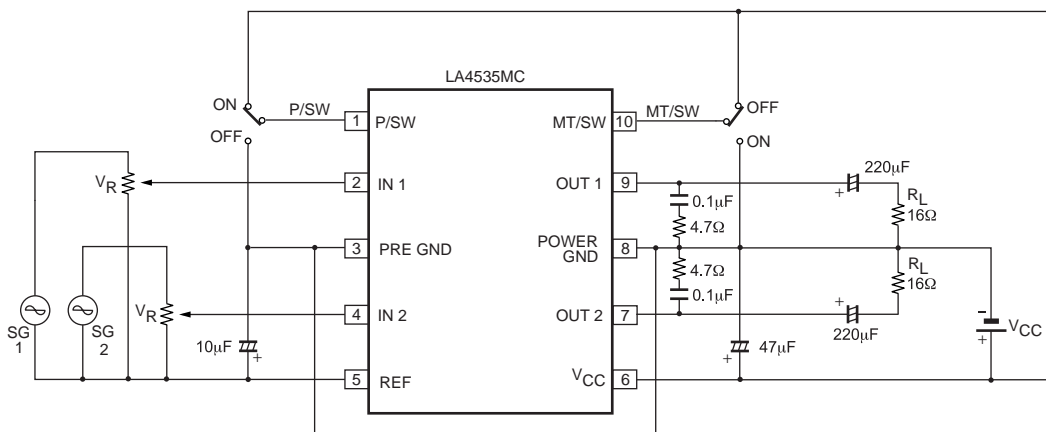

# LA4535MC

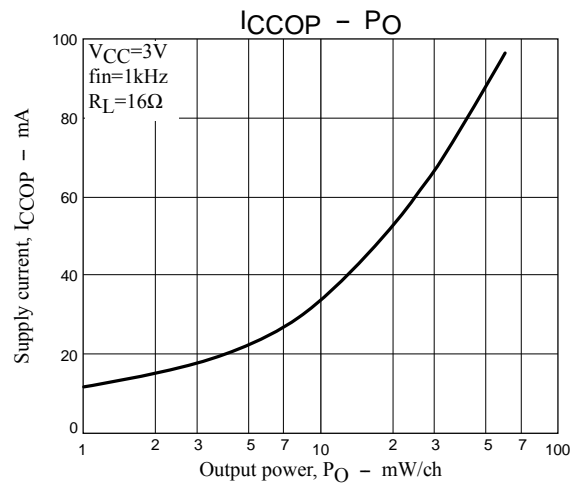
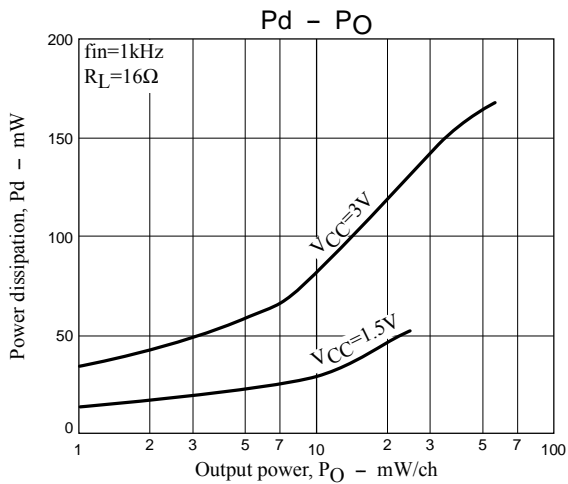
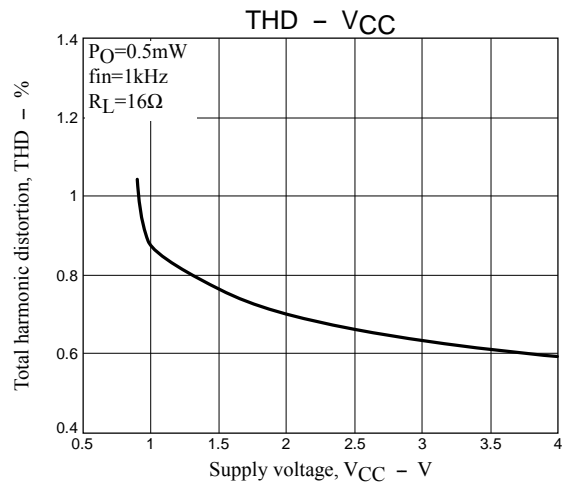
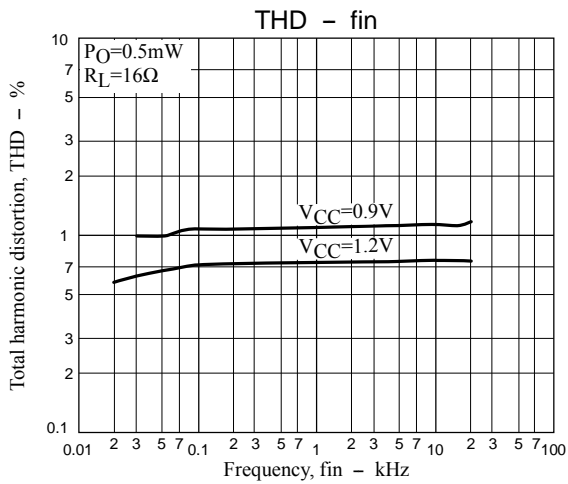
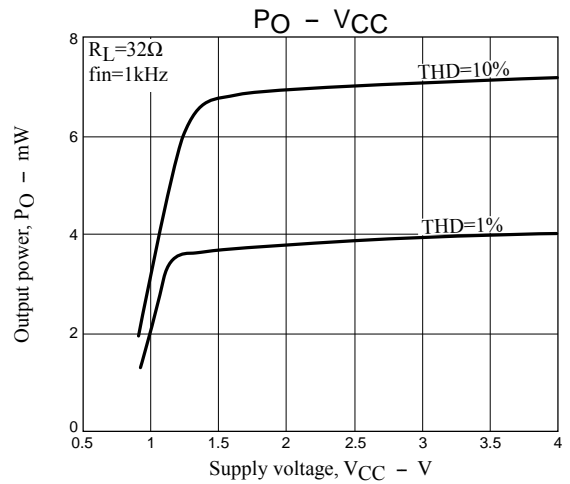
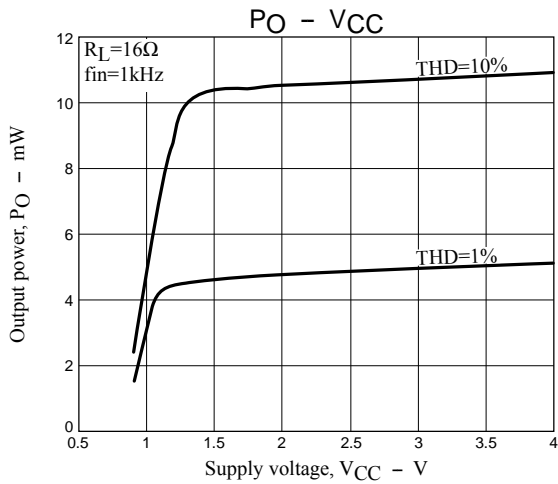
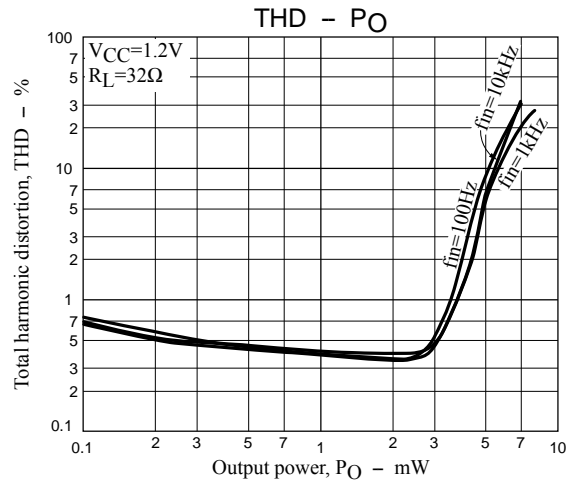
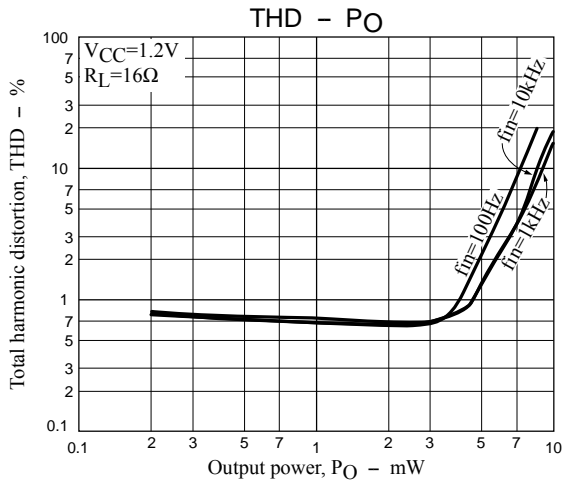

# LA4535MC

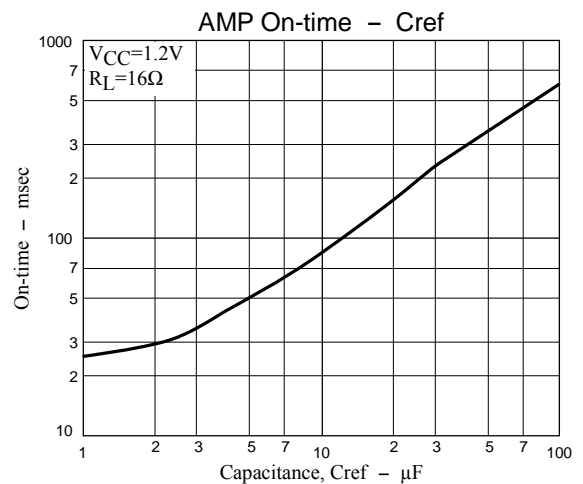
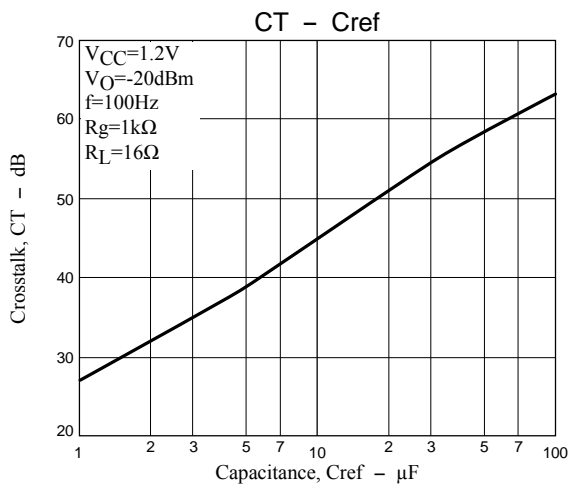
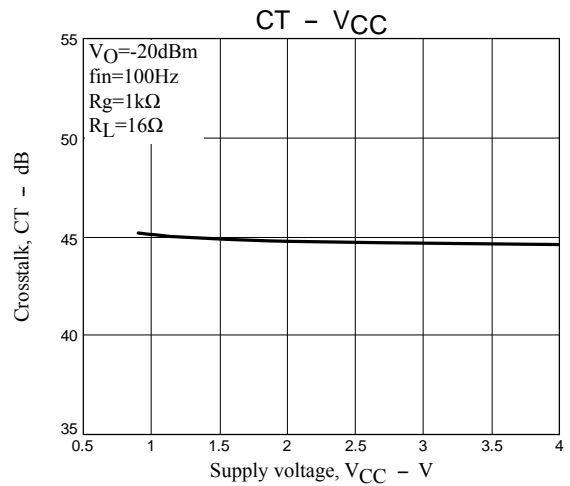
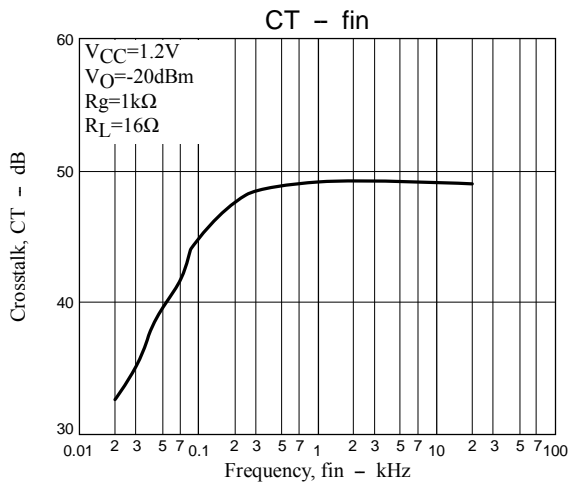
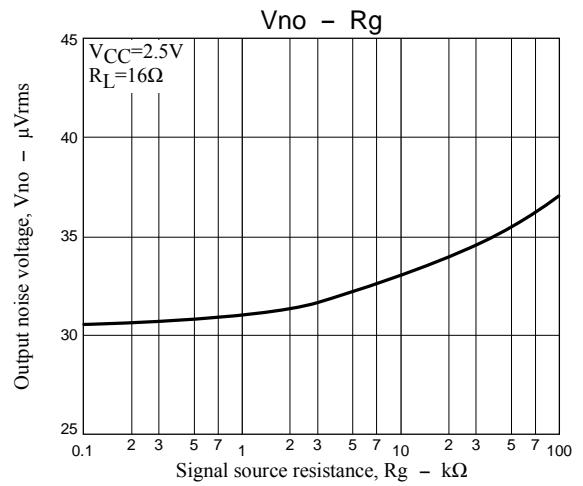
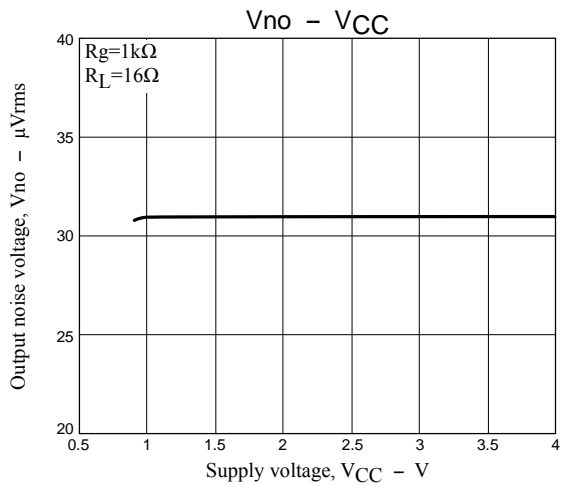
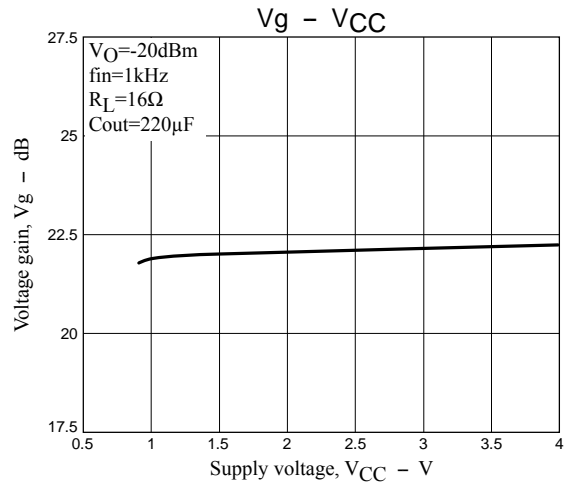
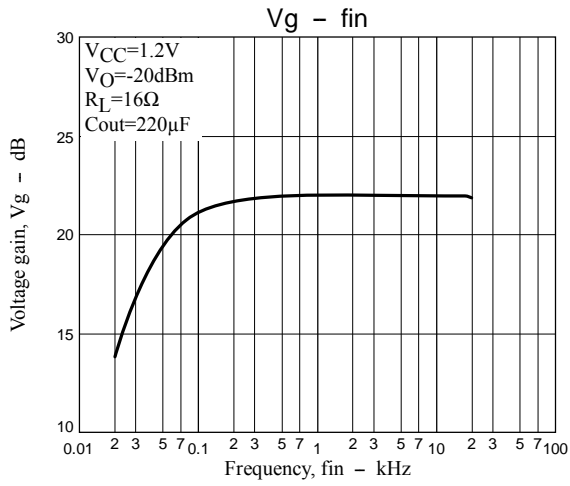

# LA4535MC

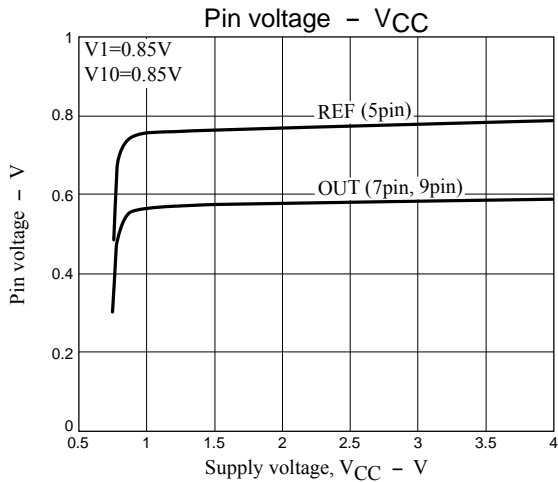
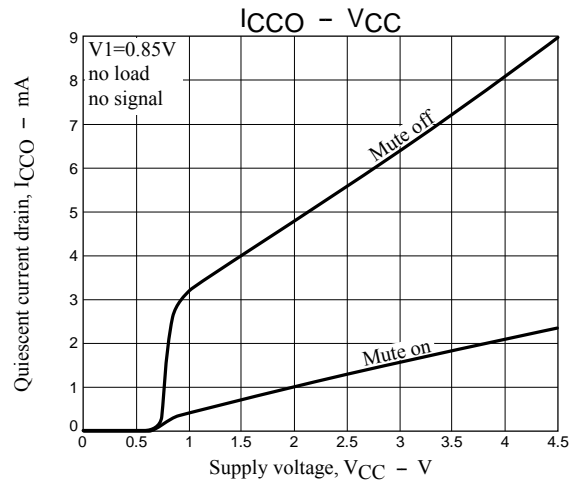
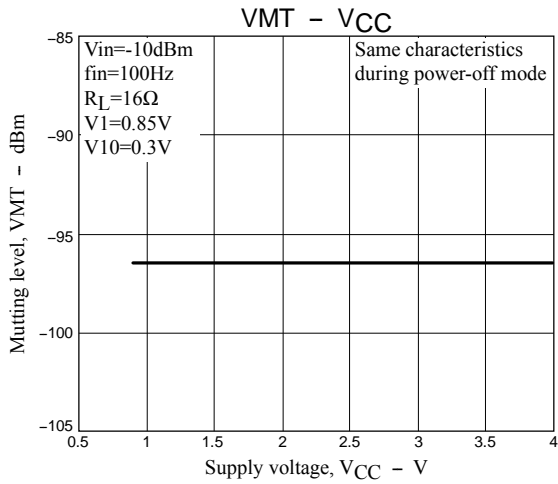
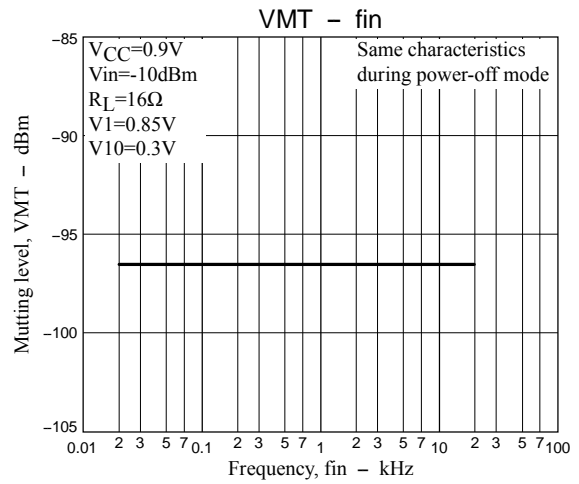
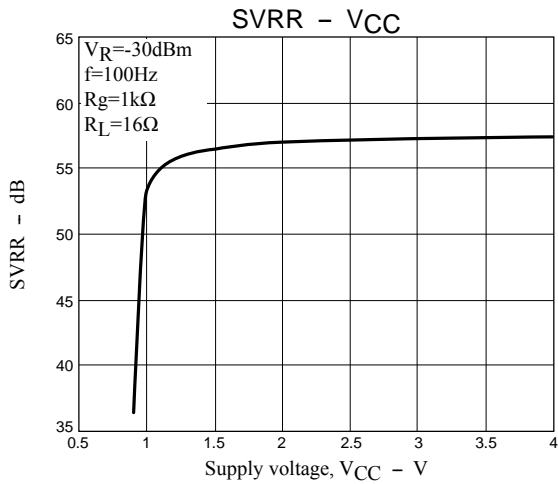
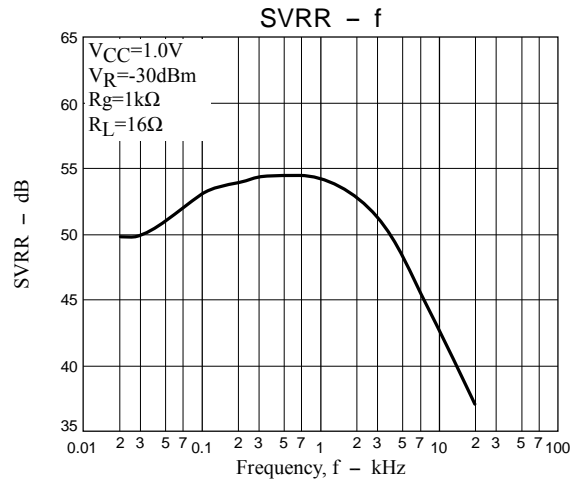
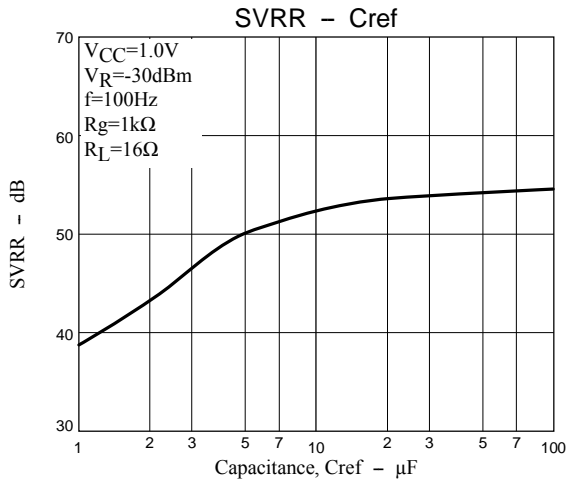

ON Semiconductor and the ON logo are registered trademarks of Semiconductor Components Industries, LLC (SCILLC). SCILLC owns the rights to a number of patents, trademarks, copyrights, trade secrets, and other intellectual property. A listing of SCILLC's product/patent coverage may be accessed at [www.onsemi.com/site/pdf/Patent-Marking.pdf](http://www.onsemi.com/site/pdf/Patent-Marking.pdf). SCILLC reserves the right to make changes without further notice to any products herein. SCILLC makes no warranty, representation or guarantee regarding the suitability of its products for any particular purpose, nor does SCILLC assume any liability arising out of the application or use of any product or circuit, and specifically disclaims any and all liability, including without limitation special, consequential or incidental damages. "Typical" parameters which may be provided in SCILLC data sheets and/or specifications can and do vary in different applications and actual performance may vary over time. All operating parameters, including "Typicals" must be validated for each customer application by customer's technical experts. SCILLC does not convey any license under its patent rights nor the rights of others. SCILLC products are not designed, intended, or authorized for use as components in systems intended for surgical implant into the body, or other applications intended to support or sustain life, or for any other application in which the failure of the SCILLC product could create a situation where personal injury or death may occur. Should Buyer purchase or use SCILLC products for any such unintended or unauthorized application, Buyer shall indemnify and hold SCILLC and its officers, employees, subsidiaries, affiliates, and distributors harmless against all claims, costs, damages, and expenses, and reasonable attorney fees arising out of, directly or indirectly, any claim of personal injury or death associated with such unintended or unauthorized use, even if such claim alleges that SCILLC was negligent regarding the design or manufacture of the part. SCILLC is an Equal Opportunity/Affirmative Action Employer. This literature is subject to all applicable copyright laws and is not for resale in any manner.