



SARK-110

Vector Impedance Antenna Analyzer

User's Manual

Revision 1.3.8

Updated to Firmware Version 0.10.x



This document is licensed under a Creative Commons Attribution-NonCommercial-ShareAlike 3.0 Unported License.

© Melchor Varela – EA4FRB 2011-2018

Contents

1	INTRODUCTION.....	4
1.1	OVERVIEW.....	4
1.2	MAIN FEATURES.....	5
1.3	OVERVIEW OF FUNCTIONS.....	6
1.4	PRECAUTIONS.....	7
1.5	REGULATORY COMPLIANCE.....	7
2	OPERATING THE SARK-110	8
2.1	SCREEN LAYOUT.....	8
2.2	STATUS SYMBOLS MEANING.....	9
2.3	MEANS OF INPUT.....	10
2.4	MAIN MENU	11
2.5	CHANGING THE FREQUENCY.....	13
2.6	CHANGING THE SPAN.....	14
2.7	CHANGING THE START AND STOP FREQUENCIES.....	15
2.8	FREQUENCY PRESETS.....	16
2.9	USING MARKERS.....	17
2.10	CHANGING THE VERTICAL AXIS PARAMETER.....	21
2.11	SAVING AND RECALLING MEASUREMENTS.....	21
2.12	TAKING SCREENSHOTS.....	27
2.13	CHANGING THE OPERATING MODE.....	28
2.14	CHANGING THE SETTINGS.....	28
3	OPERATING MODES.....	43
3.1	SCALAR CHART MODE.....	43
3.2	SMITH CHART MODE	45
3.3	SINGLE FREQUENCY MODE	48
3.4	CABLE TEST MODE (TDR)	54
3.5	FIELD MODE	57
3.6	MULTI-BAND MODE	59

3.7	SIGNAL GENERATOR MODE	62
3.8	COMPUTER CONTROL MODE	67
3.9	BAND SCAN MODE	69
4	SPECIAL FUNCTIONS.....	71
4.1	TRANSMISSION LINE ADD/SUBTRACT	71
4.2	CIRCUIT MODELS	74
4.2.1	<i>Loop Antenna/Coil</i>	74
4.2.2	<i>Capacitor</i>	77
4.2.3	<i>Quartz Crystal</i>	78
4.2.4	<i>Transmission Line</i>	80
4.3	TUNING STUBS.....	83
APPENDIX A:	THEORY OF OPERATION.....	85
APPENDIX B:	FUNDAMENTAL PARAMETERS.....	87
APPENDIX C:	UPGRADING THE FIRMWARE	89
APPENDIX D:	OSL CALIBRATION	90
APPENDIX E:	FREQUENCY CALIBRATION.....	95
APPENDIX F:	DETECTOR CALIBRATION.....	96
APPENDIX G:	FREQUENCY PRESETS FILE	100
APPENDIX H:	SCALE PRESETS	101
APPENDIX I:	CUSTOM CABLE SETTINGS	103
APPENDIX J:	SPECIFICATIONS	104
APPENDIX K:	ACKNOWLEDGMENTS	106

1 Introduction

1.1 Overview

The SARK-110 Antenna Analyzer is a pocket size instrument providing fast and accurate measurement of vector impedance, VSWR, vector reflection coefficient, return loss and R-L-C (as series or parallel equivalent circuits). Additionally, the analyzer features a TDR (Time Domain Reflectometer) mode which is intended for fault location and length determination in coaxial cables as well as a programmable RF signal generator.

The SARK-110 is intended for standalone operation but also operates when connected to a personal computer in combination with SARK Plots client software for Windows, further enhancing the device's capabilities.

Typical applications include checking and tuning antennas, impedance matching, component testing, cable fault location, measuring coaxial cable losses and cutting coaxial cables to precise electrical lengths. As a signal generator it is ideal for receiver calibration, sensitivity tests and signal tracing.

The SARK-110 features a Direct Digital Synthesis (DDS) generator with a range of 0.1 to 230 MHz and a frequency resolution of 1 Hz. The instrument has full vector measurement capability and accurately resolves the resistive, capacitive and inductive components of a load. The measurement reference plane is automatically adjusted via the Open/Short/Load calibration procedure for higher measurement accuracy. Also, the analyzer implements a transmission line addition or subtraction feature in order to make antenna measurements while discounting the effect of the feed line.

The user interface, based on a color display, has been designed to be intuitive and easy to use. The graphical impedance displays provide a quick view of the antenna impedance characteristics on a user-selected sweep range. This includes the graphical plot of two user-selectable parameters in a scalar chart or a complex reflection coefficient in Smith chart form. To help speed up measurements, two markers are available, both of which are user positionable or can operate in automatic tracking mode.

The Multiband mode is a unique feature of the SARK-110, whereby it is able to display simultaneously the plot of an impedance parameter in four scalar charts. This feature is ideal for tuning multiband antennas.

Also included is a single frequency measurement mode that presents a complete impedance parameter analysis at a user selectable frequency and displays diagrams of equivalent circuits.

The analyzer uses an internal 2MB flash disk for the storage and recall of measured parameters, screenshots, analyzer configuration and firmware updates. This disk is accessible via USB so the measured parameters can be downloaded to a PC for analysis using the ZPLOTS spreadsheet program or the SARK Plots client software for Windows.

Please let us have your suggestions through the website <http://www.sark110.com> as we are highly motivated to extend this device's functionality, based on community requests.

1.2 Main Features

- Pocket size and lightweight
- Solid aluminum case
- Intuitive and easy to use
- Operating modes: Scalar Chart, Smith Chart, Single Frequency, Cable Test (TDR), Field Mode, Multi-band, Signal Generator, Computer Control and Band Scan
- Good accuracy over a broad range of impedances
- Resolves the sign of the impedance
- Manual and automatic positioning tracking markers
- Internal 2MB USB disk for the storage of measurements, screenshots, configuration and firmware upgrade
- Exports data in ZPLOTS-compatible format for further analysis on a PC
- SARK Plots client software for Windows
- Lifetime free firmware upgrades
- Open to community requested features
- Open source Software Development Kit (SDK) including a device simulator for development of user applications

1.3 Overview of Functions

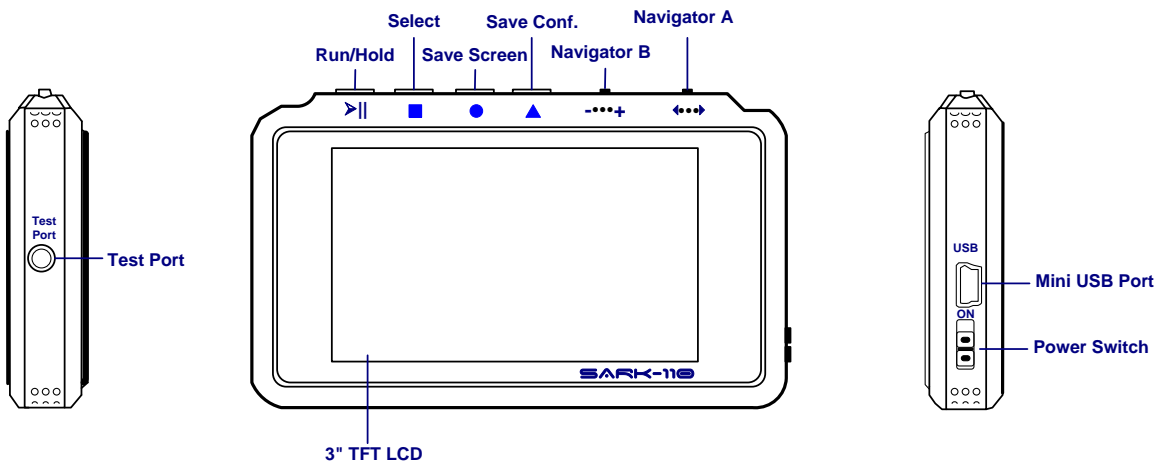

The unit has a Test Port located on its left side, to connect to the device under test. This receptacle accepts straight MCX plug connector types. The product pack includes an MCX to SMA female connector adapter and a 20-cm SMA plug to SMA female cable adapter.

The USB port located on the right side facilitates connection to a personal computer for communication and internal battery charging using a compatible mini-USB cable (not included). The unit charges the internal battery when connected to USB. The internal battery charger automatically manages the charge cycle and stops the process when the battery is fully charged. The complete charge cycle takes around 3.5 hours.

Slide the Power Switch button located on the right side to the ON position to turn the unit on. An automatic power-off feature can be set for power-saving after a user-specified period of inactivity.

Operation is controlled by four buttons and two navigation keys located on the top side of the unit. A 3" TFT color LCD is used to display diagrams.

1.4 Precautions

1. *Never connect the unit to an antenna during a lightning storm and windy dry days. Lightning strikes and static discharges can damage the unit and may kill the operator.*
2. *Static build-up on an antenna may cause damage to the unit when connected. As a precaution, before plugging the coax cable into the analyzer always discharge the antenna by momentarily shorting the center and outer conductors of the connecting coax cable together and then touching the coax connector shell to the analyzer to equalize the charge. After operation, always disconnect the antenna.*
3. *Maximum safe RF input is 2V peak (+16 dBm). Exceeding this RF level may damage the unit. Note that powerful active transmitters nearby may induce a high RF voltage on the antenna.*
4. *Test port is DC coupled. Use an external series capacitor for measurement scenarios whereby a DC voltage is present.*
5. *This product emits a low power RF signal during its active measurement mode. When connected to an antenna system, this radiation may cause interference to nearby communication systems. Connect only for as long is necessary.*
6. *On first time use, it is recommended saving the factory files in a safe place. Please connect the device to a PC via an USB cable and copy the files in the internal disk to a location in your PC.*

1.5 Regulatory Compliance

SARK-110 is certified for CE compliance under regulations EN61000-4-2 and EN55022.

2 Operating the SARK-110

This chapter provides information about the SARK-110's basic functionality and user interface.





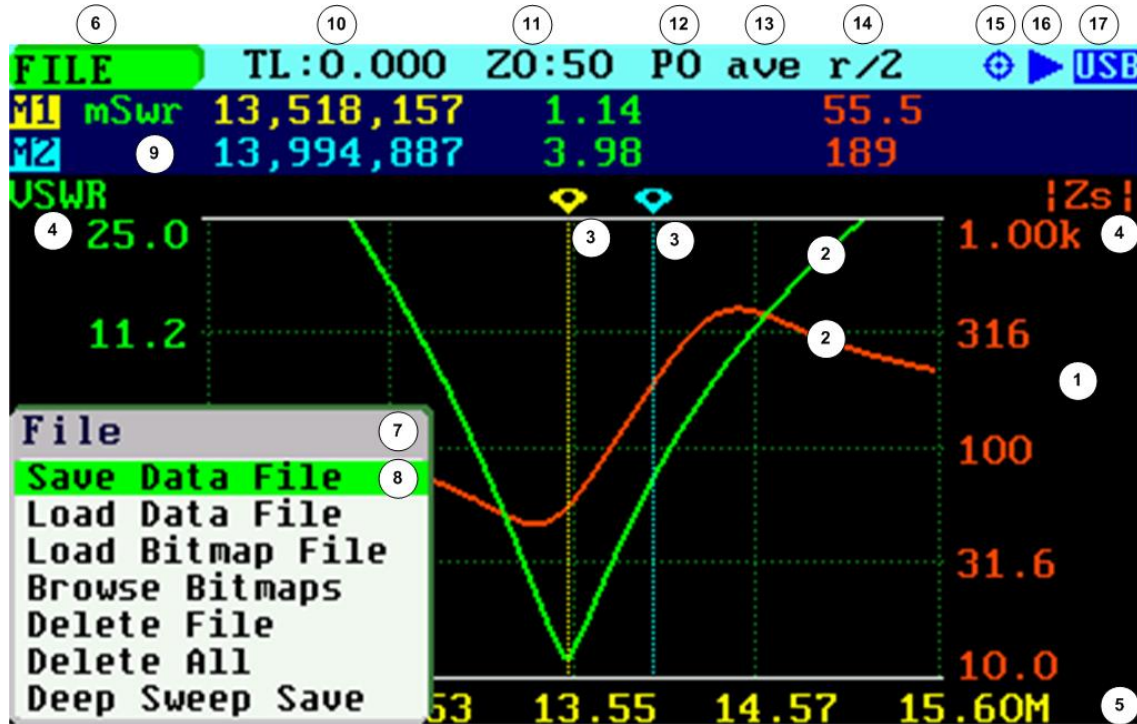

2.1 Screen Layout

The following figure shows the screen layout in Scalar Chart mode. It shows diagram areas that are the same for all operating modes of the SARK-110. Screen layouts that show specifics for each operating mode are provided in corresponding sections of this manual.



1	Diagram	10	Transmission Line length setting
2	Traces	11	Reference impedance setting
3	Markers	12	Calibration profile
4	Vertical axis labeling	13	Filter setting
5	Horizontal axis labeling	14	Sampling setting
6	Active main menu option	15	Calibration status
7	Submenu	16	Run/Hold status
8	Selected submenu option	17	USB/Battery status
9	Markers information window		

2.2 Status Symbols Meaning

Calibration status		Calibrated
		Not calibrated
Run/Hold status		Measurements in progress
		Measurements on hold
USB/Battery status		Device operating from USB
		Battery charge status when operating from battery
Disk		Disk write operation in progress
Zoom (Smith Chart)	Zoom:E	Zoom Extends
	Zoom:1o	Zoom 1 st Octave
	Zoom:1s	Zoom 1 st Sixteenth
	Zoom:nq	Zoom 1 st to 4 th (n) Quarter
Sampling	d/s	Double sampling
	r/2	Normal sampling – resolution 1/2
	r/4	Normal sampling – resolution 1/4
	r/8	Normal sampling – resolution 1/8
Filter	ave	Average
	smo	Smoothing

2.3 Means of Input

There are four buttons and two navigation keys on the SARK-110.

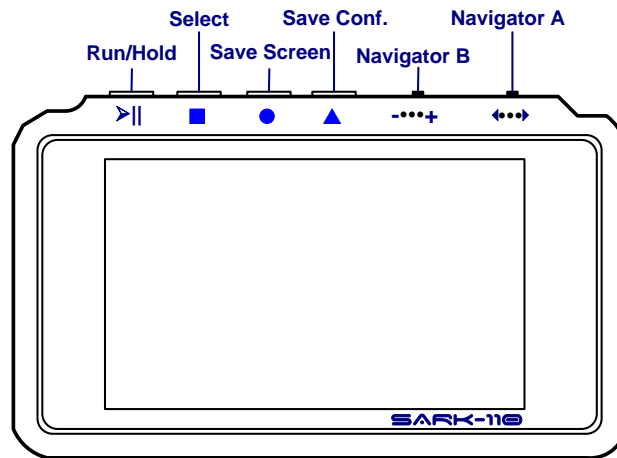

Navigator A

Navigator A is used to navigate within the main menu.

Navigator B

Navigator B is used for changing the value of the active option in the main menu (for Freq, Span, Marker1, Marker2, LeftY and RightY) and to navigate within the popup submenus.

Run/Hold [▶ ||]

The Run/Hold button is used to control the operating state of the SARK-110: Running or Holding. In the holding state the signal generator and measurement circuits are inactive.

- **Note:** when loading a stored data file the analyzer is automatically placed in a holding state.

Select [■]

The button is used to activate the popup submenu associated with the highlighted option and for selecting the desired option within the popup submenu.

- **Note:** Pressing any other button will cancel a selection.

Save Screen [●]

The Save Screen button is used to take a screenshot of the current screen. The screenshot is stored on the internal flash disk.

- Since firmware version v0.10.7, Save Screen [●] button can be used to launch Setup menu if pressed for few seconds.

Save Conf. [▲]

The Save Conf. button is used to store the complete analyzer state and settings. The stored state is restored automatically after the device is powered on.

- Since firmware version v0.10.7, the analyzer state and settings are saved automatically. Save Conf. [▲] button can be used to launch Mode menu.

2.4 Main Menu

The main menu is the primary navigation tool. Navigator A is used to change the active menu option. If the Main Menu setup option is enabled, a popup menu is shown automatically when the Navigator A right or left buttons are pressed; see the screenshot below. The active menu option is shown on the top left side of the screen

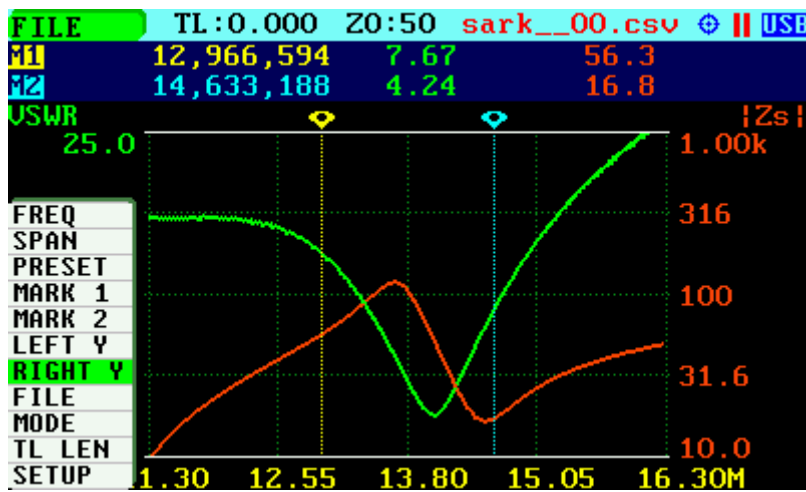

Figures below illustrate the main menu options available for each mode.

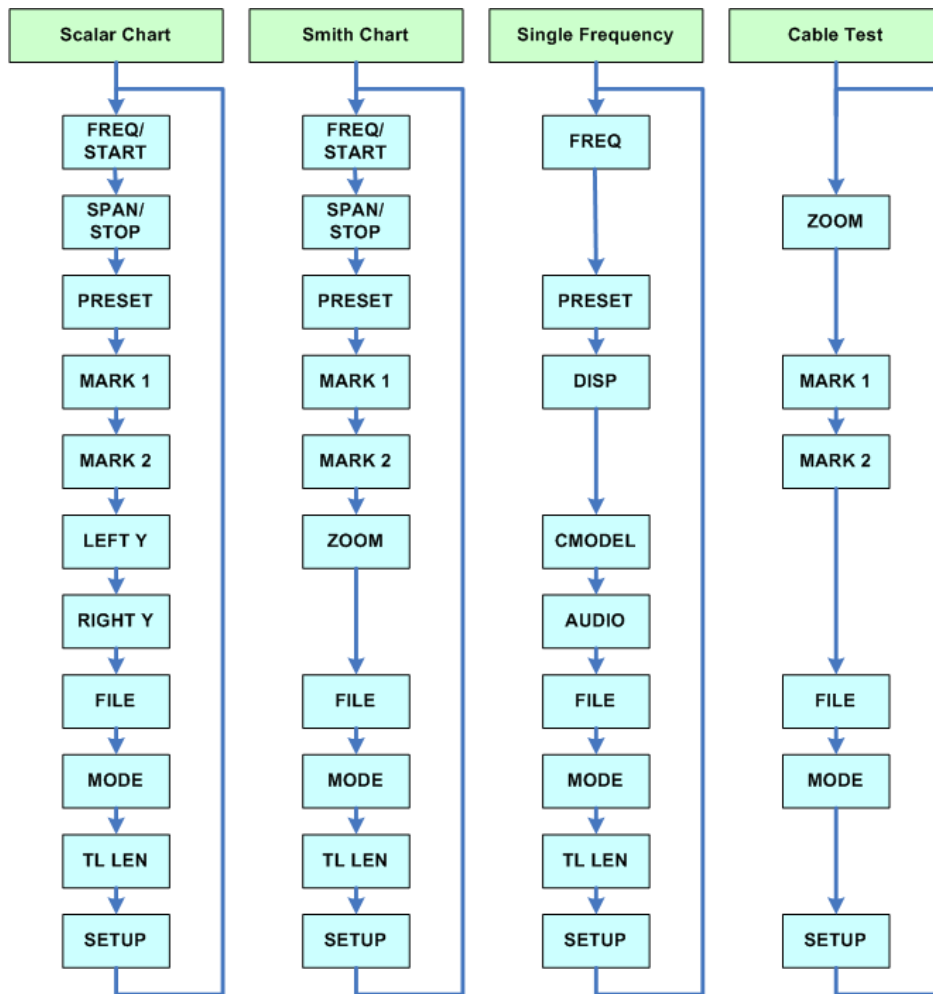

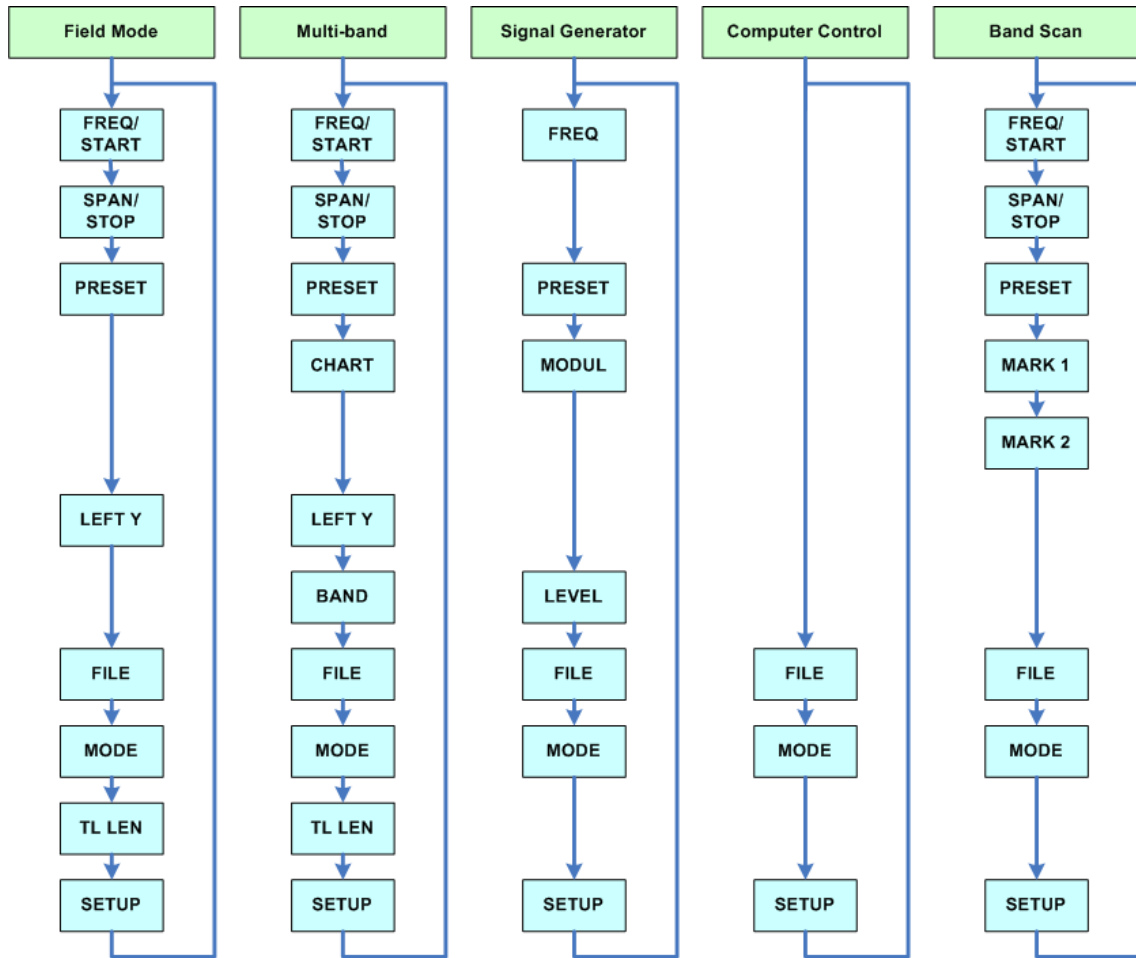

2.5 Changing the Frequency

There are two methods of editing the frequency (center frequency for sweep modes):

- (i) Use Navigator A to select «**FREQ**» in the main menu. Press the Select [■] button to display the popup dialog associated with «**FREQ**». Then use Navigator B to change the frequency. The frequency will change according to the current frequency multiplier that is highlighted in reverse video. Use Navigator A to change the frequency multiplier position if needed. Press the Select [■] button to validate the frequency selection. Press any other button to cancel the operation.

The screenshot below is of the frequency edit dialog, showing the highlighted frequency multiplier positioned over digit 5 from right to left (frequency increments of 10 KHz).

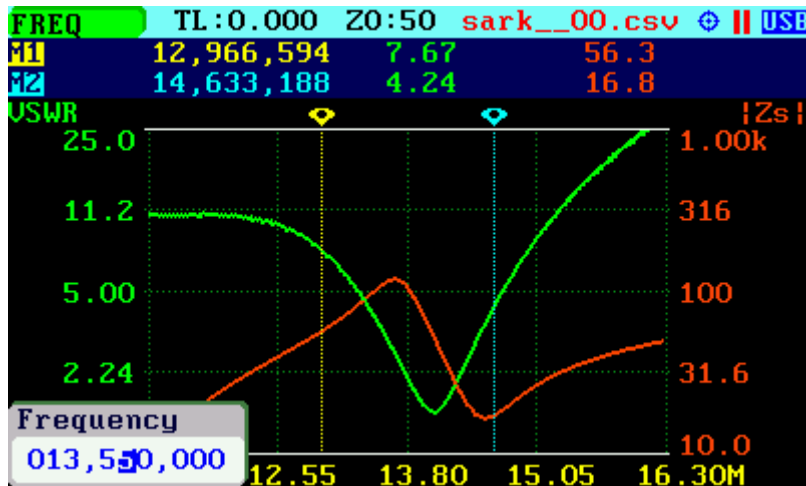

(ii) Use Navigator A to select «FREQ» in the main menu. Then use Navigator B to change the frequency. The frequency will change according to the current frequency multiplier. The frequency multiplier can be changed from the popup dialog, see (i) above.

- **Note:** the span range will be adjusted automatically if the resultant upper or lower frequency entry causes it to fall outside operational limits.

2.6 Changing the Span

There are two methods of editing the Span:

(i) Use Navigator A to select «SPAN» in the main menu. Press the Select [■] button to display the popup dialog associated with «SPAN». Then use Navigator B to change the span. The span will change according to the current span frequency multiplier that is highlighted in reverse video. Use Navigator A to change the span frequency multiplier position if needed. Press the Select [■] button to validate the span selection. Press any other button to cancel the operation.

The screenshot below is of the span edit dialog, showing the span frequency multiplier positioned over digit 6 from right to left (frequency increments of 100 kHz).

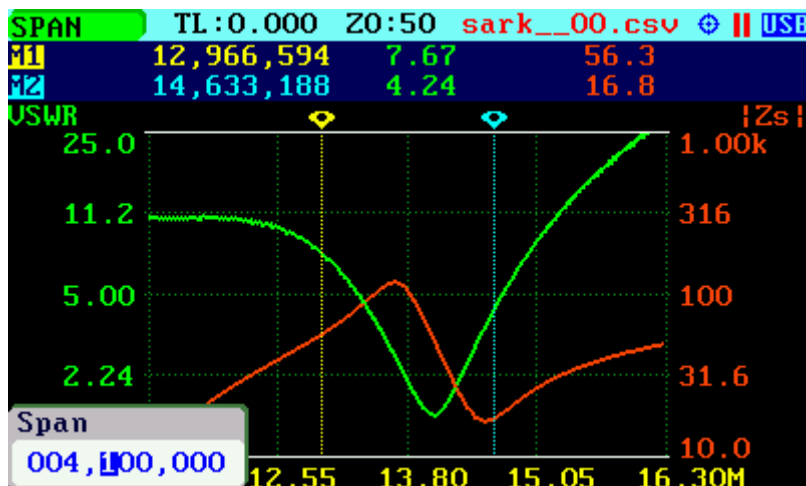

(ii) Use Navigator A to select «SPAN» in the main menu. Then use Navigator B to change the span. The span will change according to the current span frequency multiplier. The span frequency multiplier can be changed from the popup dialog, see (i) above.

2.7 Changing the Start and Stop Frequencies

For sweep modes it is also possible specifying the Start and Stop frequencies. Use Navigator A to select «FREQ» or «SPAN» in the main menu and then press Navigator A to change the entry mode. These main menu options will change to display «START» and «STOP». Pressing the Navigator A again will revert to the «FREQ» and «SPAN» entry mode.

The screenshot below shows the main menu changed to allow the entry of «START» and «STOP» frequencies.

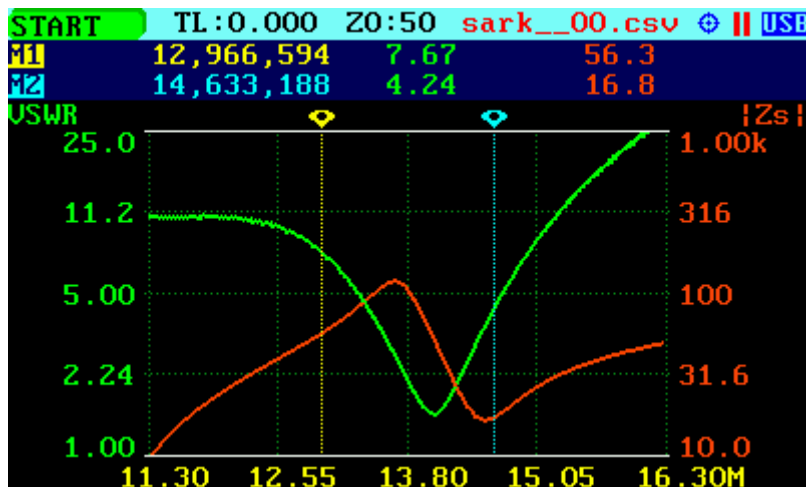

Operation is similar to the «FREQ» or «SPAN» entry:

(i) Use Navigator A to select «START» or «STOP» in the main menu. Press the Select [■] button to display the popup dialog. Then use Navigator B to change the frequency. The frequency will change according to the current frequency multiplier that is highlighted in reverse video. Use Navigator A to change the frequency multiplier position if needed. Press the Select [■] button to validate the frequency selection. Press any other button to cancel the operation.

(ii) Use Navigator A to select «START» or «STOP» in the main menu. Then use Navigator B to change the frequency. The frequency will change according to the current frequency multiplier. The frequency multiplier can be changed from the popup dialog, see (i) above.

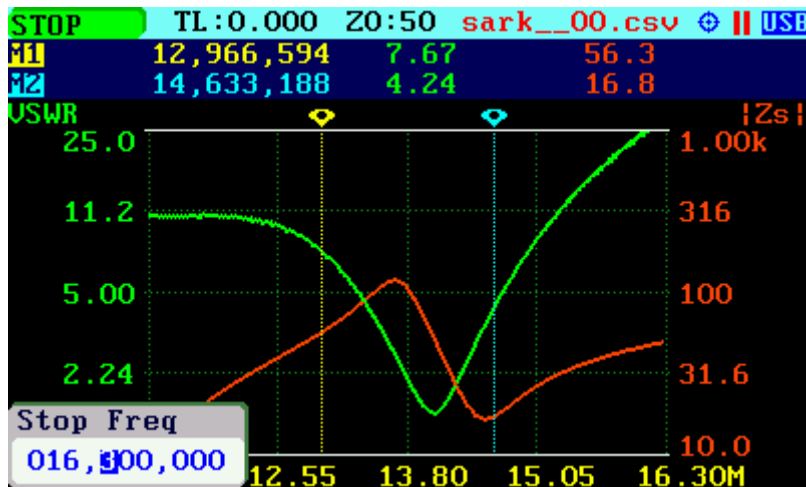
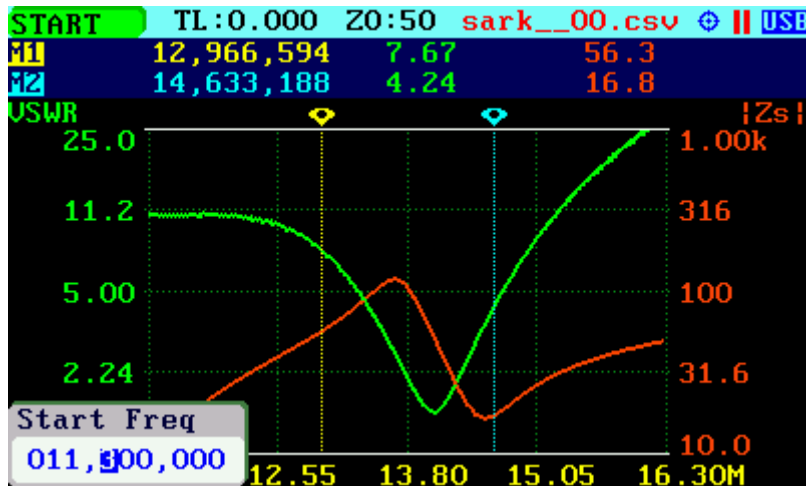

2.8 Frequency Presets

The analyzer provides predetermined frequency and span settings including the amateur radio bands and other suitable settings. Use Navigator A to select «PRESET» in the main menu.

Press the Select [■] button to activate the Preset popup submenu. Use Navigator B to highlight the desired preset. Press the Select [■] button to validate the preset selection. Press any other button to cancel the operation.

See in the screenshot below the available presets:



2.9 Using Markers

The SARK-110 has two markers that can either be manually positioned by the user or set to operate in automatic tracking mode. The markers indicate the horizontal and vertical position of the point on which they are positioned. The horizontal position of a marker is shown by a dotted vertical line which extends from the top to the bottom of the measurement diagram. The markers information window, in blue background, shows the frequency (or distance in cable test mode) and the two values that correspond to the plotted values at each of the markers.

Use Navigator A to select either «MARK 1» or «MARK 2» in the main menu.

Press the Select [■] button to activate the Marker popup submenu. Available options are: «Enable» for activating or deactivating the marker, «Tracking» for selecting the tracking mode, «Info» to display detailed information and «Center» to set the center frequency at the marker position; see screenshot below:



The automatic tracking feature makes positioning of the markers easier, thus helping the user to speed up measurements.

The following tracking modes are available:

- Peak Min (p)
- Peak Max (P)
- Absolute Min (m)
- Absolute Max (M)
- Value Cross Any (X)
- Value Cross Up (^)
- Value Cross Down (v)

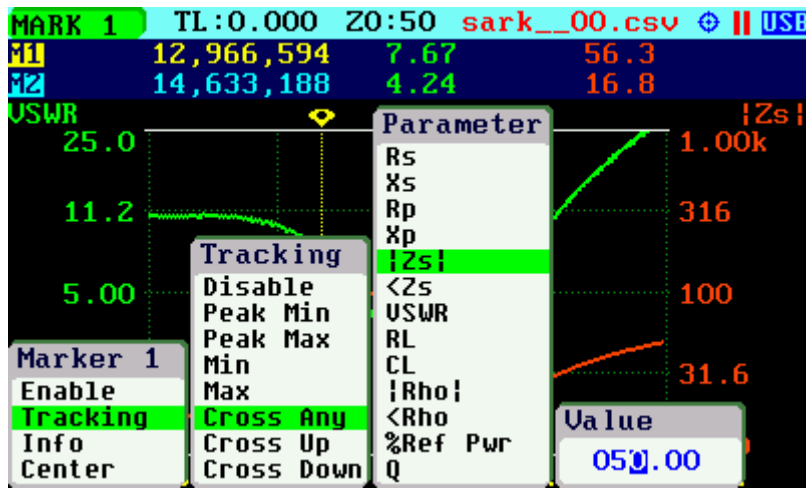

The automatic positioning of markers is activated in the «Tracking» sub-option. Select the tracking mode from any of the modes above and then the applicable parameter to track. In addition, a detection value must be specified for the Cross detection modes.

For example, you could set Marker 1 to automatically track the minimum VSWR values in the trace: «MARK 1» «Tracking» «Peak Min» «VSWR»; and Marker 2 to track the crossovers on the 50-ohm impedance value: «MARK 2» «Tracking» «Cross Any» «Z» «50.0».

You could also program the unit to detect the bandwidth by setting «MARK 1» «Tracking» «Cross Down» «VSWR» «2.0»; and «MARK 2» «Tracking» «Cross Up» «VSWR» «2.0».

Navigator B will be used to move to the different detection points, except for the Max and Min tracking modes where logically there is only a single detection point.

The tracking mode for each marker is shown in the markers information window. This information is displayed in red if either the data is not available or if the tracking condition cannot be resolved; otherwise it is displayed in green.

The screenshot below shows Marker 1 tracking the minimum value of VSWR and Marker 2, tracking all |Z| crossing at 50-ohms:

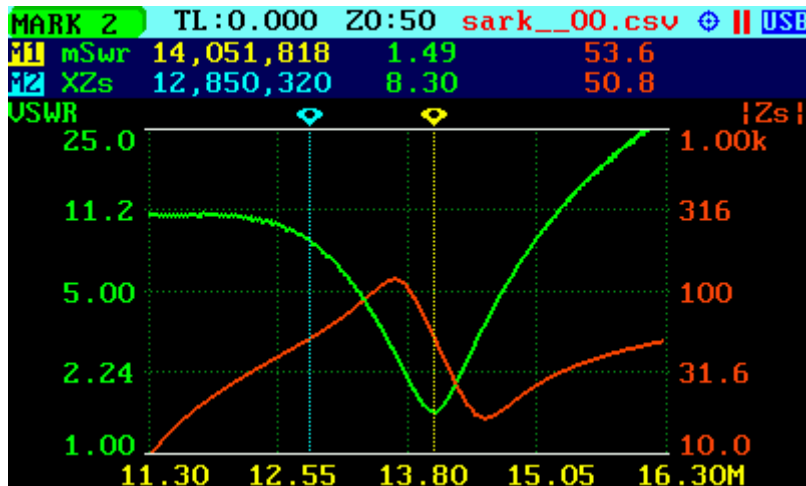

The «Info» option displays detailed information of the readings at the marker position, including the difference in frequency between both markers. One possible use of this feature is determining the VSWR bandwidth of an antenna.

Besides, the display includes the calculation of electrical length of a line that will be useful for applications such as tuning stubs; see section 4.3.

The «Info» option can be also selected by pressing Navigator A when either «MARK 1» or «MARK 2» are highlighted.



The «Center» menu option can be used to set the center frequency at the marker's frequency value.

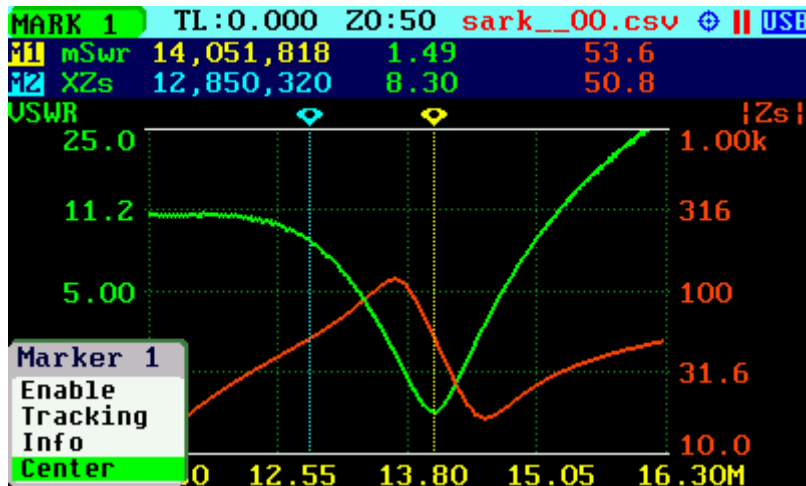

Since firmware version v0.10.6, there is the new «Data» menu option that allows selecting the data to the display at the marker position.

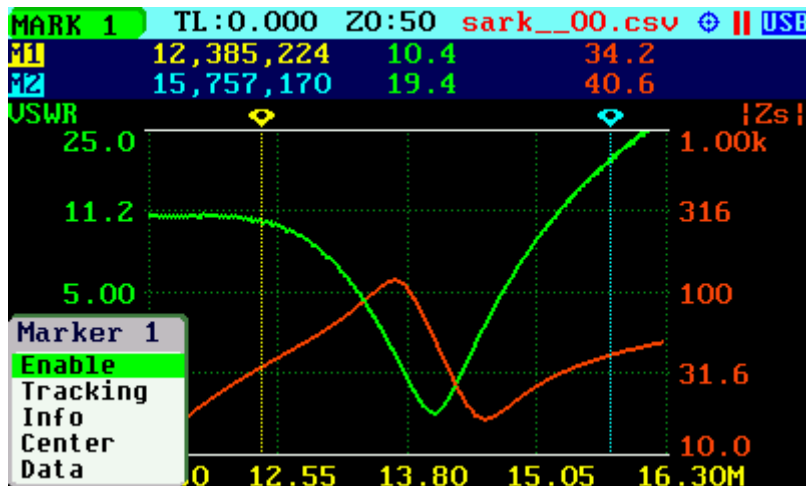

The choices are the Plot Values, Z in rectangular notation, Z in polar notation, Rho in rectangular notation or Rho in polar notation.

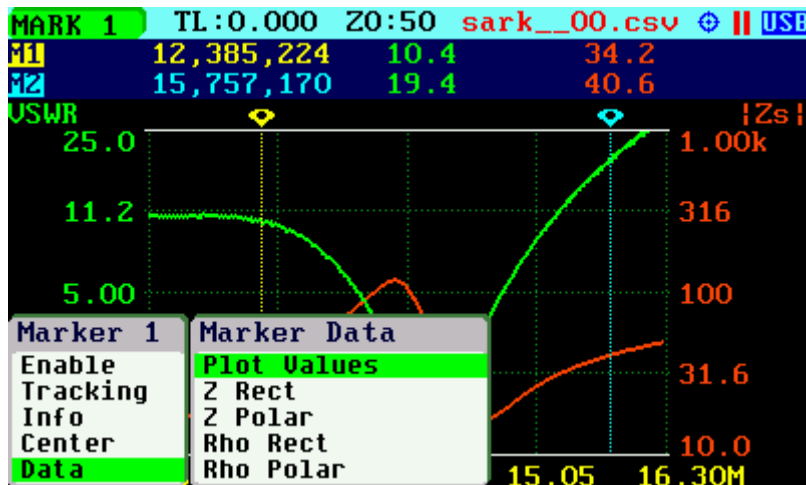

As an example, the screenshot below shows the marker 1 set to display Z in rectangular form.

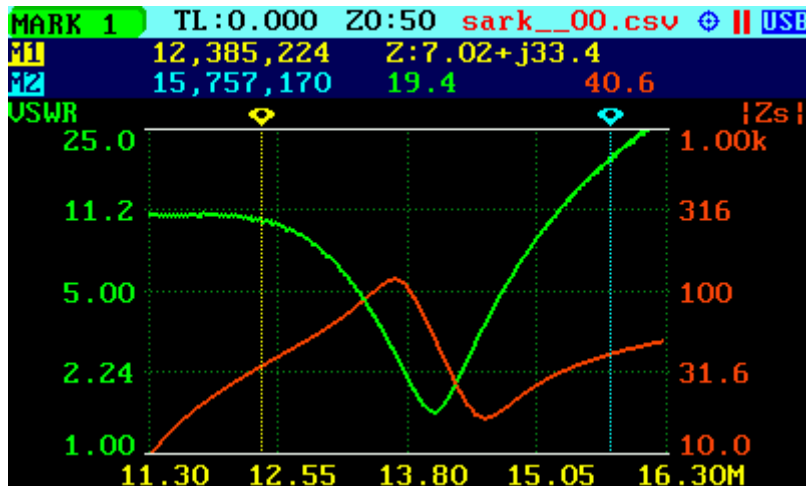

2.10 Changing the Vertical Axis Parameter

In Scalar Chart mode, the SARK-110 can display two traces from any of the available parameters for the vertical axis. Use Navigator A to select either «LEFT Y» or «RIGHT Y» in the main menu.

There are two methods of changing the selected vertical axis parameter:

- (i) Press the Select [■] button to activate the LeftY or RightY popup submenu. Use Navigator B to highlight the desired submenu parameter option. Press the Select [■] button to validate the selection. Press any other button to cancel the operation.

The screenshot below shows the available parameters for the vertical axis:

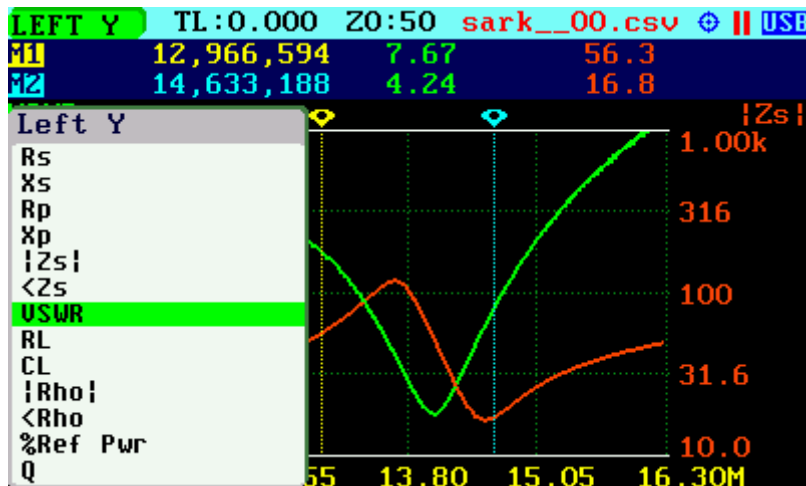

- (ii) Use Navigator B when either the «LEFT Y» or «RIGHT Y» option is highlighted. Options are selected sequentially.

2.11 Saving and Recalling Measurements

The SARK-110 has the capability to store measurements to the internal disk and recall them either to review the data later in the analyzer screen or to download the data from the USB disk

to a PC for further analysis using SARK Plots or the ZPLOTS Excel application, available from <http://www.ac6la.com/zplots.html>.

Use Navigator A to select «FILE» in the main menu for data file operations.

Press the Select [■] button to activate the File popup submenu. Use Navigator B to highlight the desired submenu File option.

«Save Data File»

The Save Data File option enables the current measured data to be saved for further review:

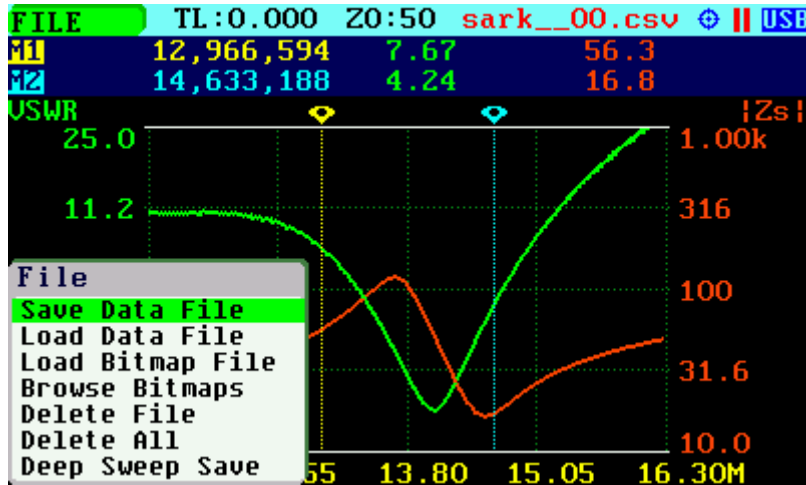

After selecting the «Save Data File» submenu option, enter the file name. By default, the file name has the format “sark__xx.csv” (or “sark__xx.tdr” for Cable Test mode), where xx is an automatically assigned number. To change the file name, use Navigator B to change the character value and Navigator A to change the character position highlighted in inverse video. Press the Select [■] button to validate the selection. Press any other button to cancel the operation.

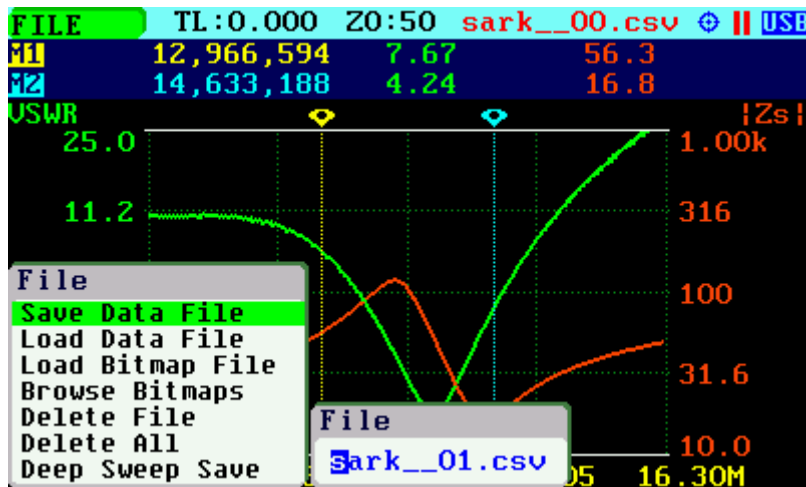

The «Save Data File» option can be also selected by pressing Navigator A when «FILE» is highlighted.

If the file base name (the name without the xx numbers) is changed, it will be recalled in subsequent save data operations. In the example below, if the file base name is changed to EA4FRB in the first save data operation, then the same file base name will be applied to all subsequent saves of that file.

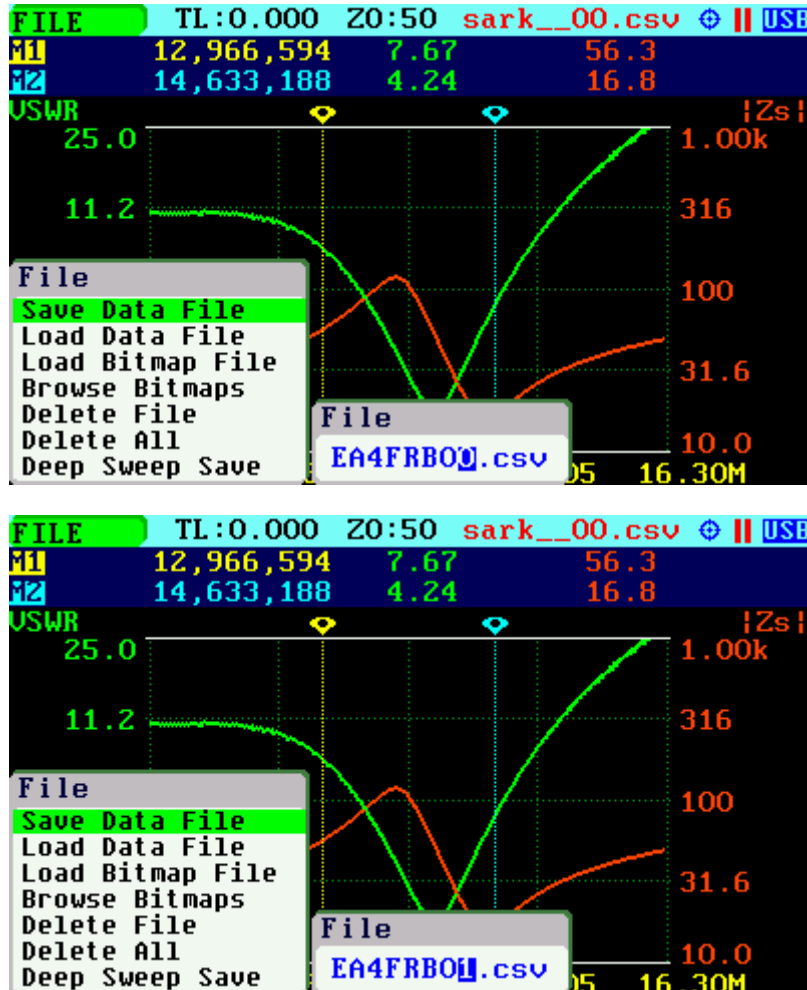

«Load Data File»

To retrieve the stored data, select the «Load Data File» submenu option. A second popup submenu is displayed with a list of available files. Use Navigator B to highlight the desired file. Press the Select [■] button to validate the selection. Press any other button to cancel the operation. Once the file is selected, the data is loaded and plotted.

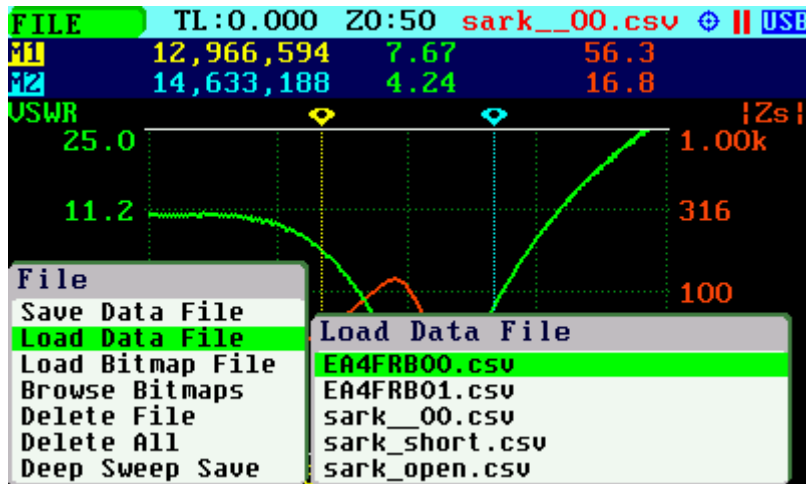

«Load Bitmap File»

Use the «Load Bitmap File» option to display a captured screenshot. Press the Select [■] button to finalize the operation.

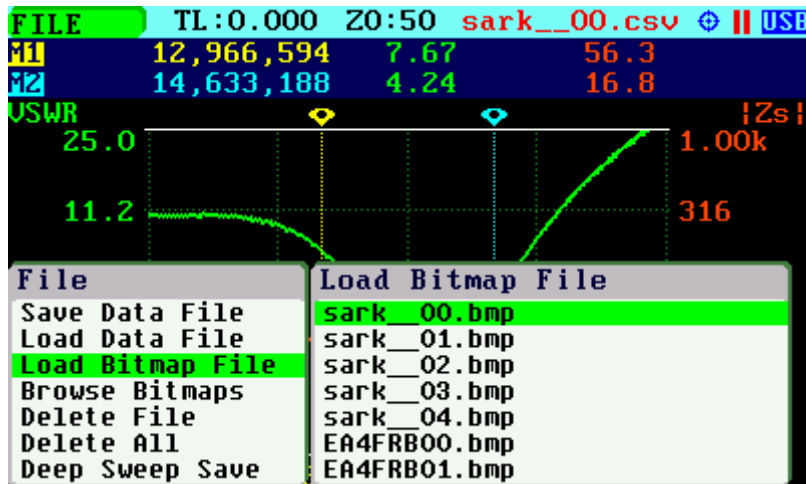

«Browse Bitmaps»

Select the option «Browse Bitmaps» from the «FILE» menu to review the captured screenshots. Use Navigator B to select the different bitmaps. Press the Select [■] button to finalize the operation.

«Delete File»

Use the «Delete file» option to delete a single file on the device disk.

When selecting the «Delete File» option a popup submenu will be displayed with the list of available files. Use Navigator B to highlight the desired file. Press the Select [■] button to validate the selection. Press any other button to cancel the operation.

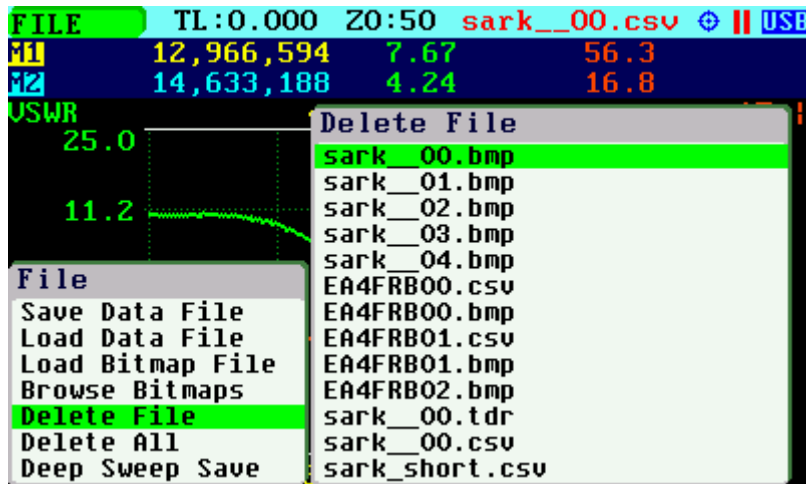

«Delete All»

Use the «Delete All» option to delete all user files.

When selecting the «Delete All» option, a confirmation dialog box is activated to prevent an accidental deletion.

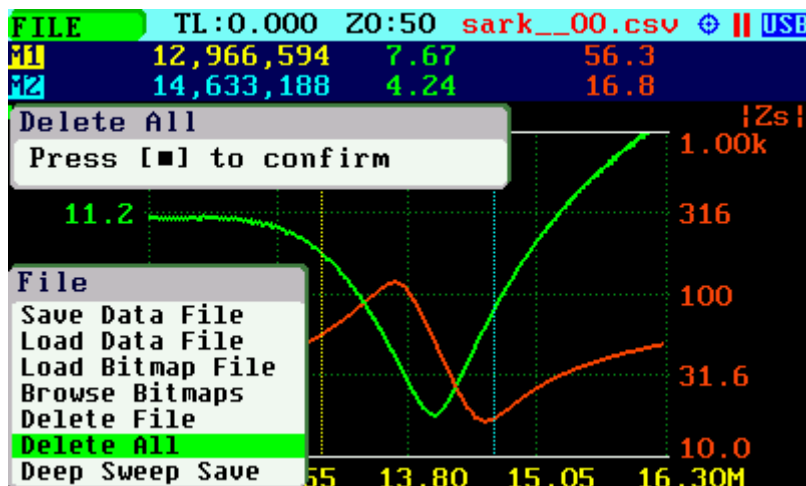

«Deep Sweep Save»

The deep sweep save function provides the capability of saving measurements with higher accuracy and resolution. It permits a higher number of frequency points to increase the frequency resolution to be specified and uses the higher accuracy settings during the sweep scan; this means a double sampling rate and an average of four measurements per single frequency point.

In addition, this function enables a user programmable timeout for the automatic start of measurements to be specified. This function is similar to the self-timer function on cameras.

In order to use this function, first set the frequency and span range in any of the sweep modes such as Scalar Chart and then select «FILE» «Deep Sweep Save».

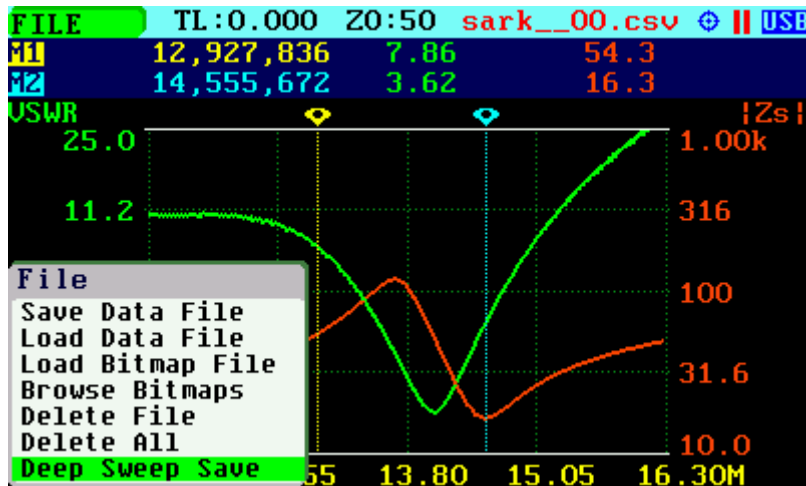

The procedure is as follows:

Enter the file name.

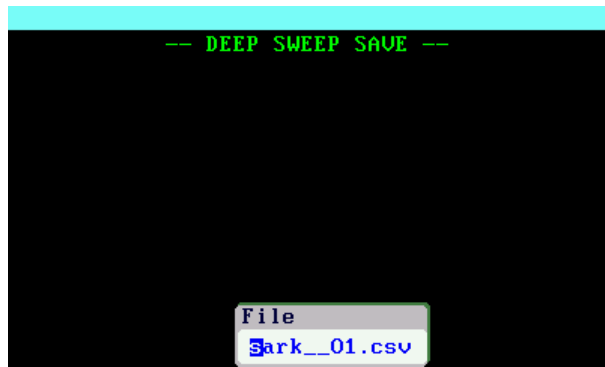

Enter the number of frequency points. Minimum value is 258 and maximum value is 10000.



Specify an optional delay for the automatic start of the measurements (self-timer function).

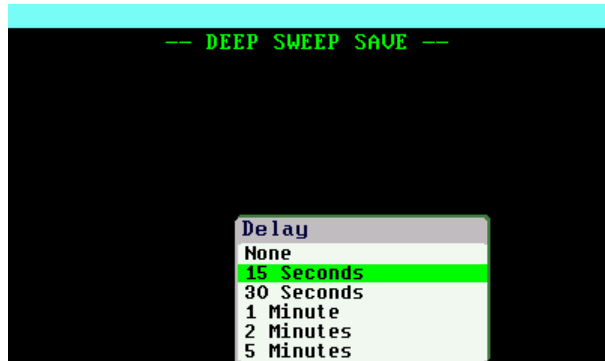

When a Delay is specified, a countdown will commence.

Otherwise, press the appropriate button to continue.

```

-- DEEP SWEEP SAVE --
File: sark__01.csv
Start: 9,100,000
Stop: 11,100,000
Points: 1000

1: Connect load

*** Count down: 10 ***

[■]:Continue [▲]:Exit
    
```

After completing the sweep scan, the analyzer will save the results of the sweep scan to the file.

Notice that the scan time is much longer than usual due to the higher accuracy setting and the additional number of points.

```

-- DEEP SWEEP SAVE --
File: sark__01.csv
Start: 9,100,000
Stop: 11,100,000
Points: 1000

Processing...
Progress 11%

[▲]:Exit
    
```

Press the appropriate button to continue.

```

-- DEEP SWEEP SAVE --
File: sark__01.csv
Start: 9,100,000
Stop: 11,100,000
Points: 1000

2: Completed

[■]:Continue
    
```

2.12 Taking Screenshots

Press the Save Screen [●] button to capture the current screen. Then enter the file name. By default the file name has the format "sark__xx.bmp", where xx is an automatically assigned number. To change the file name, use Navigator B to change the character value and Navigator A to change the character position highlighted in inverse video. Press the Select [■] button to validate the selection. Press any other button to cancel the operation.



Select the option «Load Bitmap File» or «Browse Bitmaps» from the «FILE» menu to review the captured screenshots. Also, they can be reviewed on a PC because they are in Windows bitmap compatible format.

- **Note:** the bitmap files use a significant amount of disk (48 or 94kB per screenshot)

2.13 Changing the Operating Mode

Use Navigator A to select «MODE» in the main menu.

Press the Select [■] button to activate the Mode popup submenu; see the screenshot below:

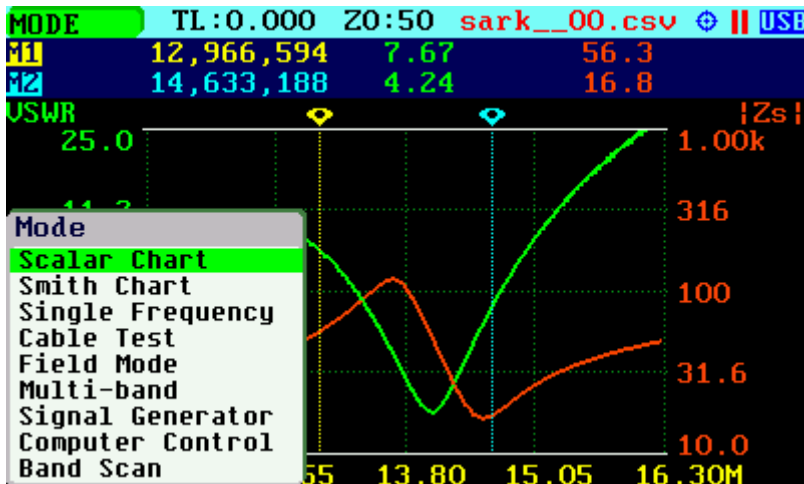

Use Navigator B to highlight the desired submenu mode option. Press the Select [■] button to validate the selection. Press any other button to cancel the operation.

- Since firmware version v0.10.7, Save Conf. [▲] button can be used to launch Mode menu.

2.14 Changing the Settings

Use Navigator A to select «SETUP» in the main menu.

Press the Select [■] button to activate the Setup popup submenu; see the screenshot below:



Use Navigator B to highlight the desired submenu setup option. Press the Select [■] button to validate the selection. Press any other button to cancel the operation.

- Since firmware version v0.10.7, Save Screen [●] button can be used to launch Setup menu if pressed for few seconds.

Setup – Rotate Screen

The Rotate Screen setup menu option can be used to flip the screen so that the device can be used upside down.

Use Navigator B to highlight the Rotate Screen submenu setup option. Press the Select [■] button to flip the screen. Repeat the process to flip the screen back.

Setup – Calibration

The calibration features are accessible through the Calibration submenu:

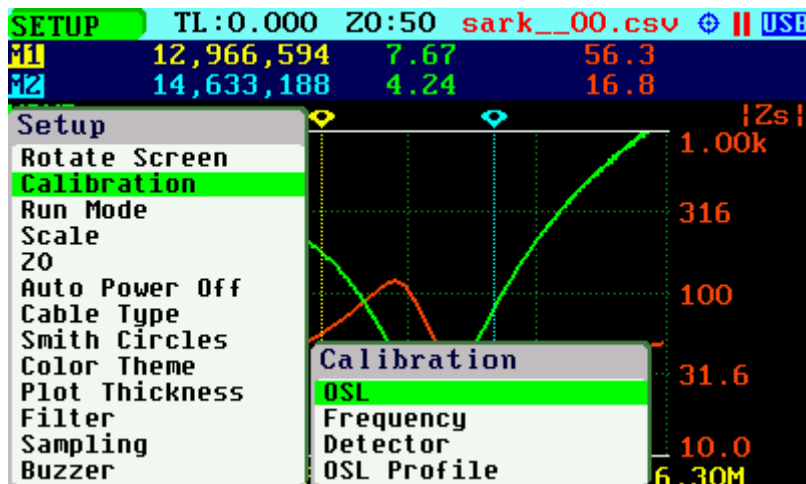

Setup – Calibration - OSL

See Appendix D:

Setup – Calibration - Frequency

See Appendix E:

Setup – Detector

See Appendix F:

Setup – Calibration - OSL Profile

See Appendix D:

Setup – Run Mode

The Run Mode setup menu option allows setting «Continuous» or «Single Shot» sweep modes.

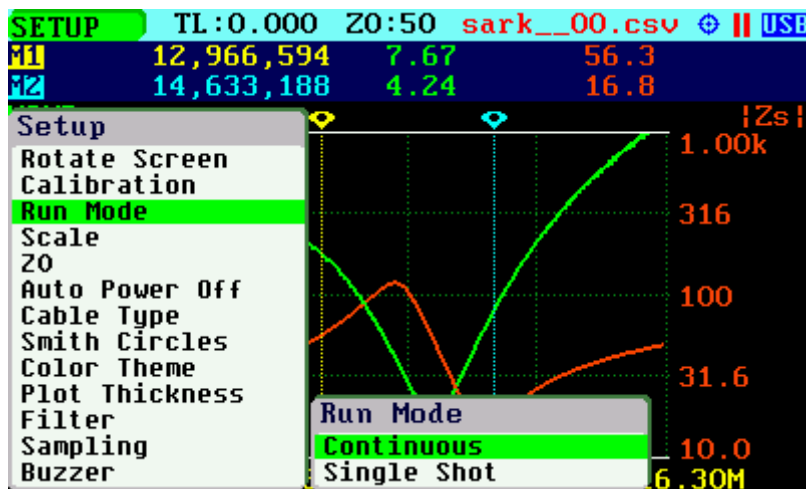

In continuous mode the analyzer is constantly sweeping provided that it is not in on hold state. In single-shot mode the sweep automatically stops on completion. Press the Run/Hold [▶||] button to start a new sweep. Notice that in the stop condition the power consumption is reduced, so using single-shot mode helps to increase the battery autonomy.

Setup - Scale

The SARK-110 provides three pre-defined scale values: Normal, High and Low as well as automatic scaling. This setting defines the maximum and minimum values for each parameter on the Y axis, see Appendix H:. This setup is valid for the Scalar Chart, Field, Cable Test (Normal and Auto only) and Multi-band modes.

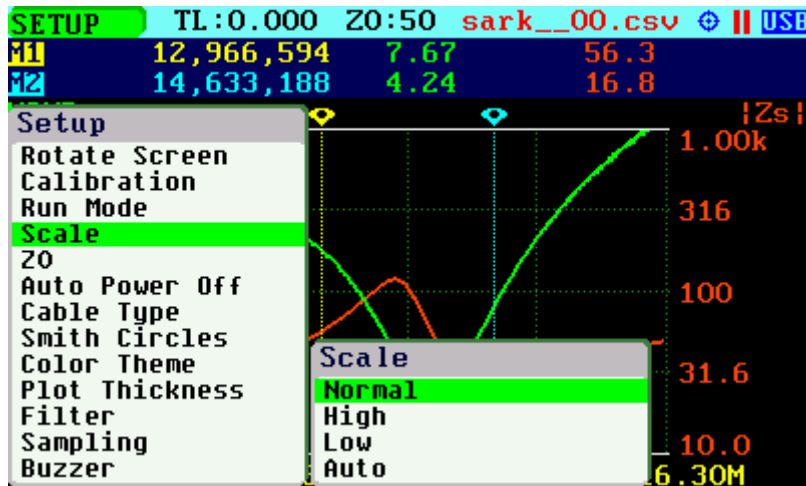

Setup - Z0

This setup permits the reference characteristic impedance to be changed. The value can be selected from a set of predetermined values or it can be user-specified selecting the Custom option.

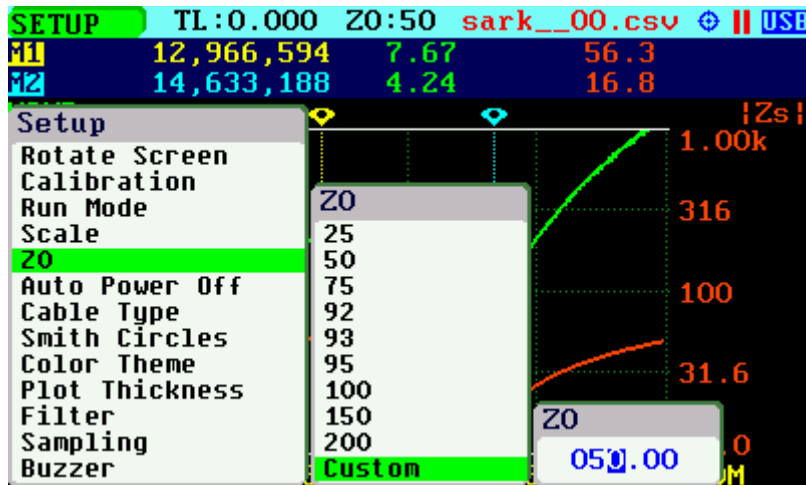
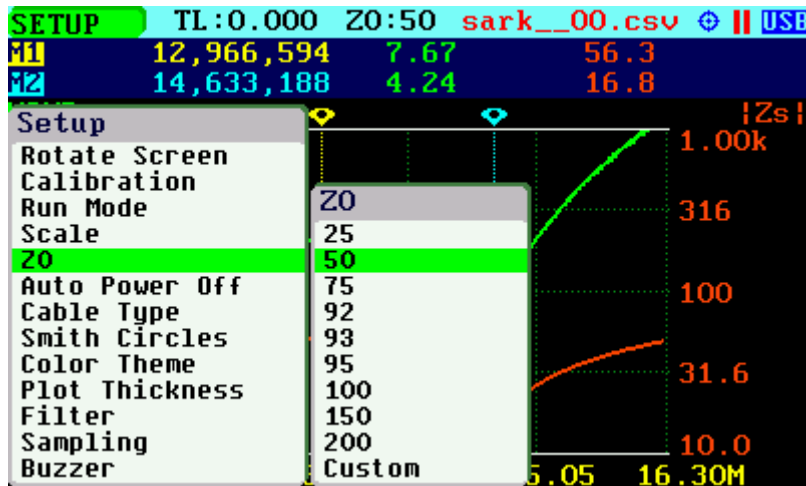

Setup - Automatic Power Off

This setup permits the automatic power off delay to be selected from a set of predefined times.

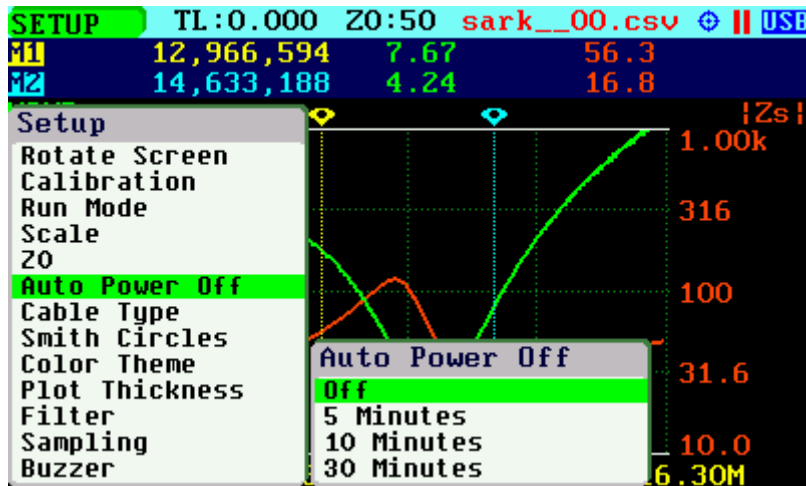

After power-off, press the Select [■] button to resume operation. Alternatively, power off and power on the device using the Power Switch.

Setup - Cable Type

The length measurements in the cable test mode and transmission line operations require the proper setting of the cable type. This setup permits the selection of cable parameters from a set of predetermined values for the most popular coaxial cables. Additionally, the user can specify three custom cable settings; see Appendix I:

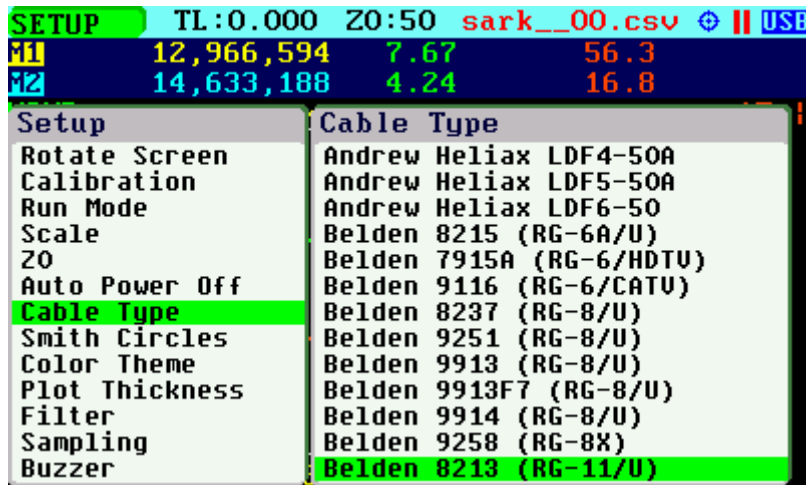

Setup – Smith Chart Circles

This setup enables the display of the constant VSWR circle or constant-Q lines.

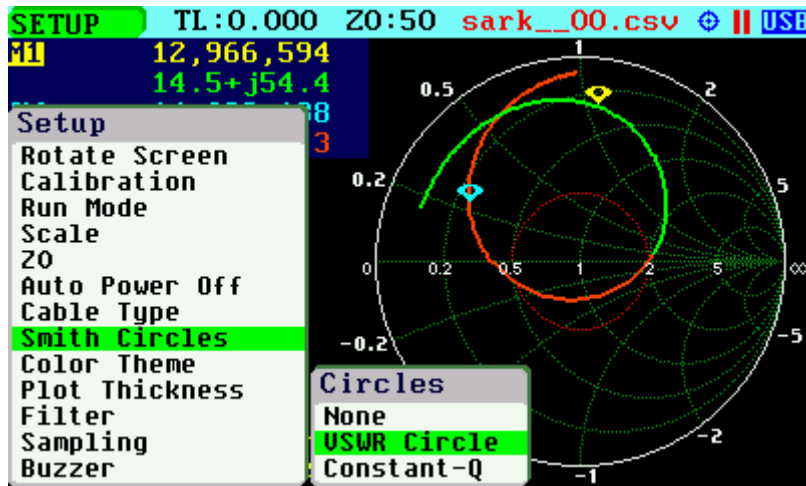

The screenshots below show how to configure a VSWR circle set at a value of 5.0.

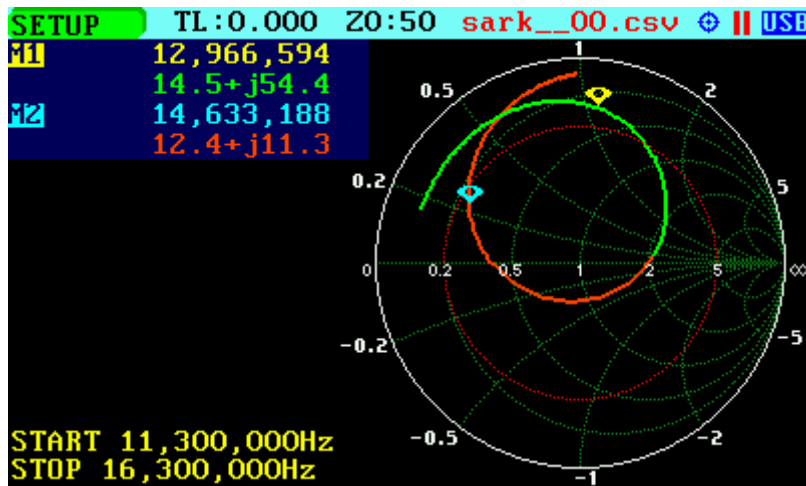
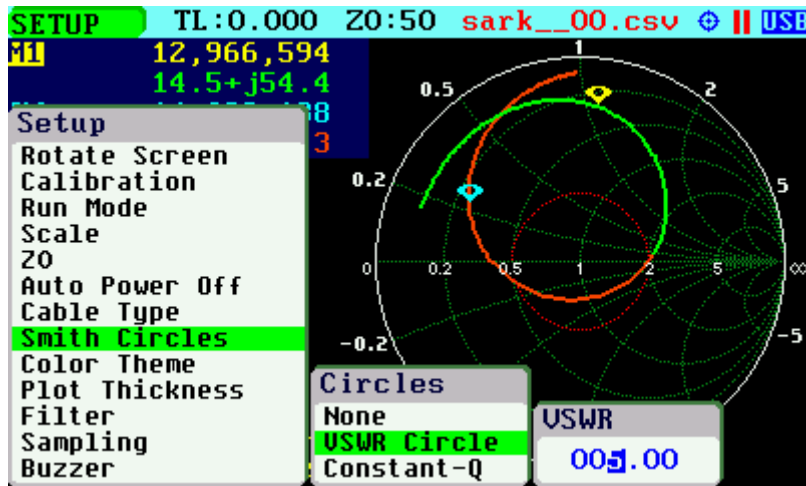

The screenshots below show how to configure constant Q-lines set at a value of Q of 1.

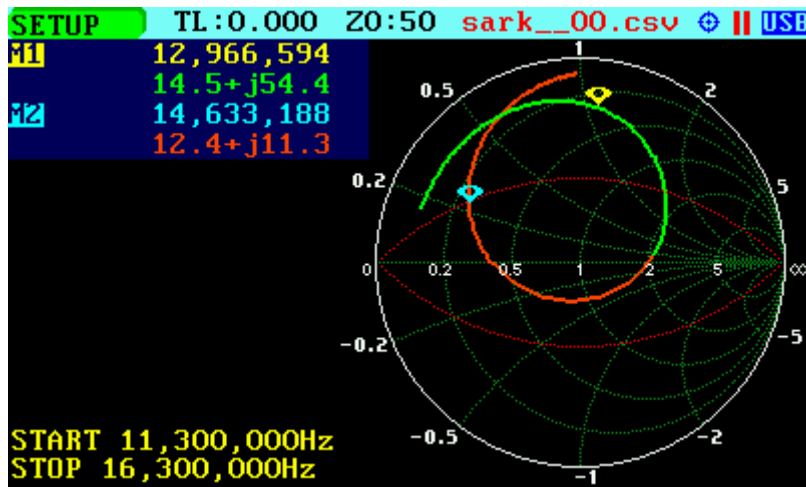
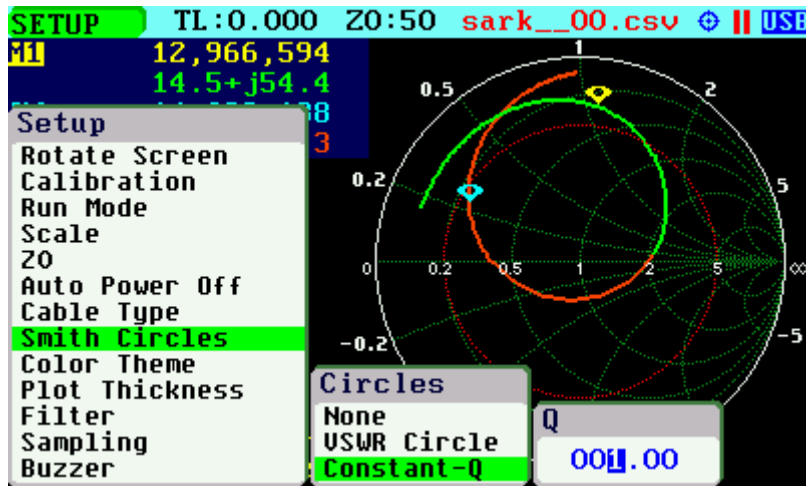

Circles can be disabled by selecting «None».

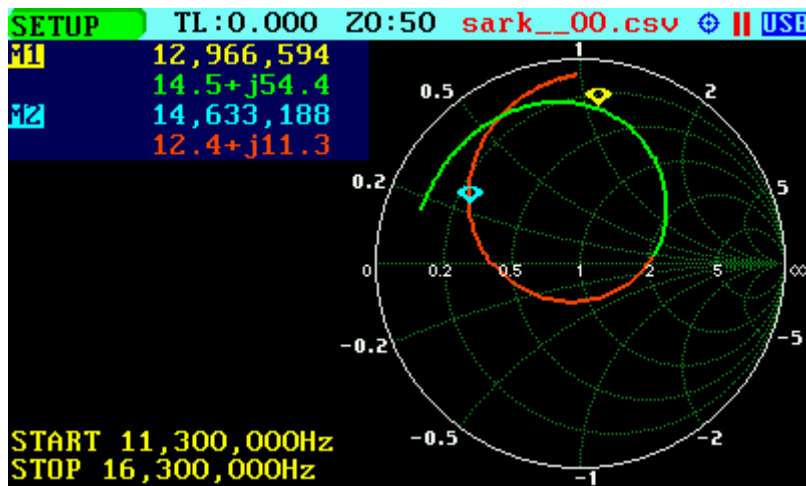

Setup – Color Theme

This setup permits a choice of two color themes: «Black» or «White».

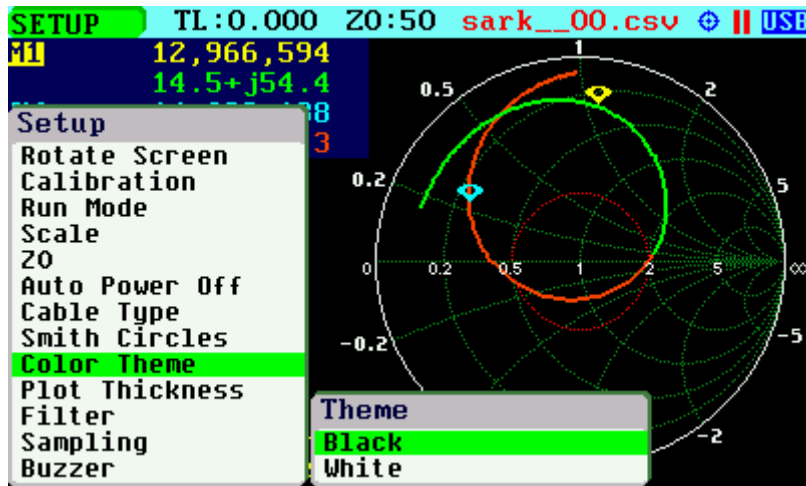

The screenshots below shows graphs with color themes set to «White» and «Black»:

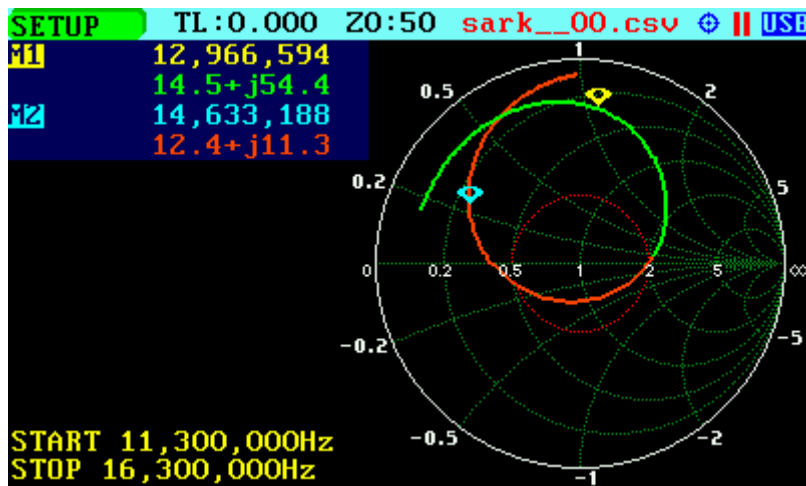
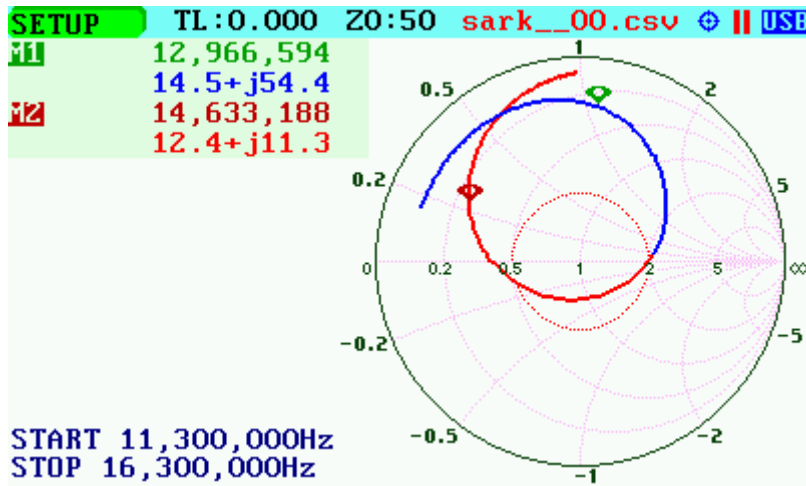

Setup – Plot Thickness

This setup allows a choice of thickness of the diagram's traces from two options: «Thick» and «Thin». This option is unavailable in the Field Mode graph, where traces are always set to thick.

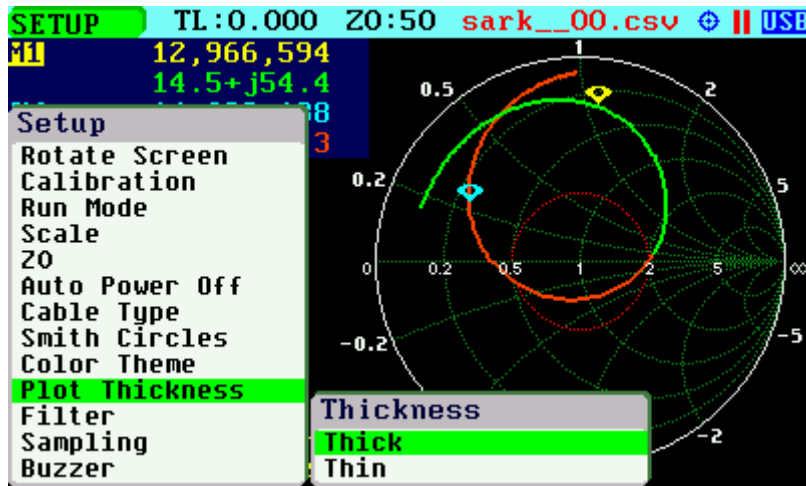

The screenshots below show graphs with plot thicknesses set to «Thick» and «Thin»:

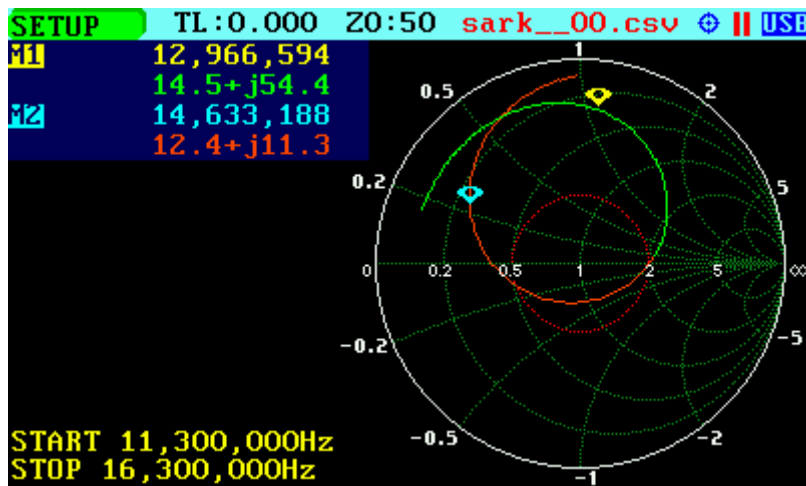
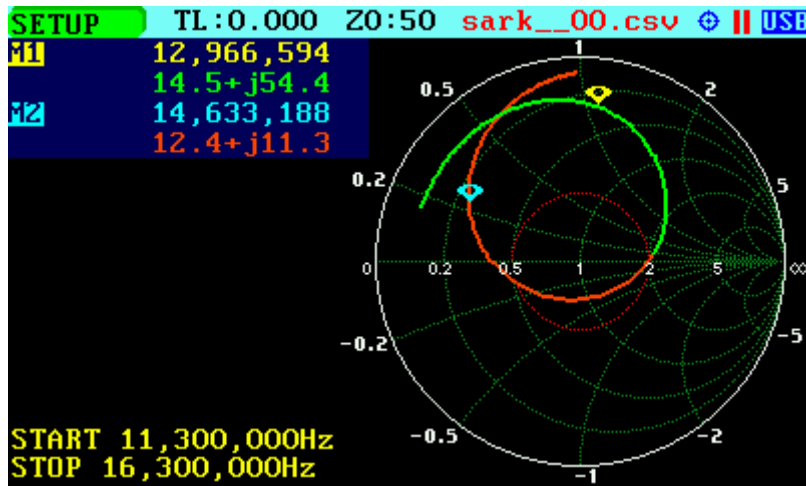

Setup – Filter

This setup offers the choice of one of two noise reduction filters or none for the Scalar Chart, Smith Chart, Field and Multi-band modes.

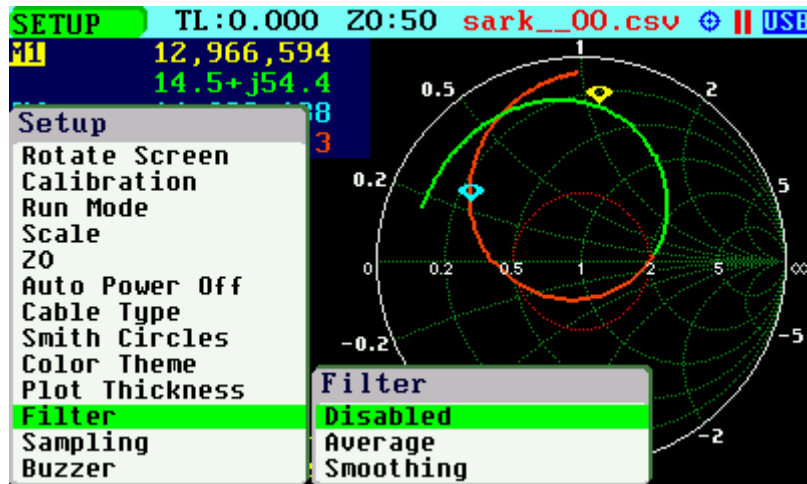

The «Average» filter minimizes the noise but at the expense of reducing the measurement speed. Four samples are taken for each measurement frequency and an average from these samples is calculated.

The «Smoothing» filter is a moving average calculation for each measurement point of the unweighted mean of the previous measurement points. The measurement speed is not affected but there could be a loss of accuracy.

- The magnitude of the peak or valley of a rapidly changing parameter may be affected. Check the results with and without the filter if there is any doubt.

Setup – Sampling

This setup permits a choice of sampling modes: «Normal», «Double», «Normal / Res. 1/2», «Normal / Res. 1/4» and «Normal / Res. 1/8». The «Normal» option is the default setting and provides a good balance between accuracy and measurement speed. The «Double » option is intended for enhanced accuracy measurements, because it reduces measurement ripple by doubling the number of samples taken, but at the expense of a slower sweep speed. This enhancement of the measurements is more noticeable when using automatic scales for measurement over a small range of values.

The rest of options are equivalent to «Normal» option, but the sweep speed is faster because the number of frequency measurement points is reduced by half, quarter or octave.

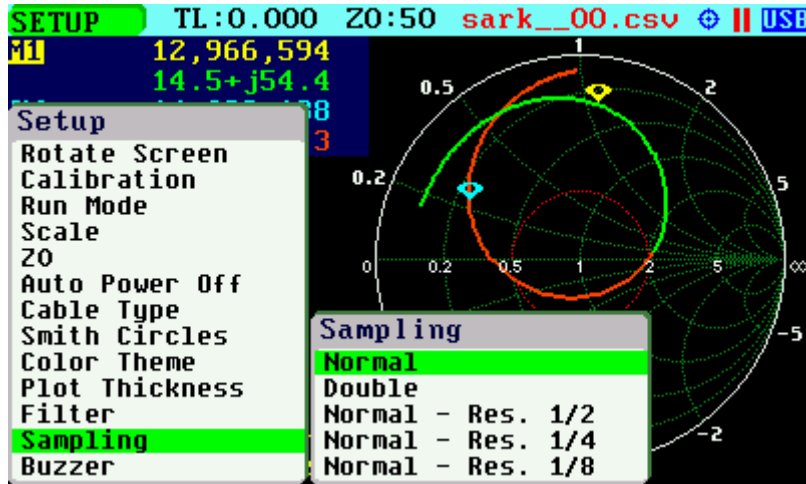

Setup – Buzzer

This setup enables control of the analyzer's sounds.

Select «Enabled» to enable all the sounds. Select «Disable Key Click» to deactivate the feedback click sound when pressing the buttons or the navigation keys. Alert and error sounds will continue to be enabled. Select «Disable All» for an all-silent operation.

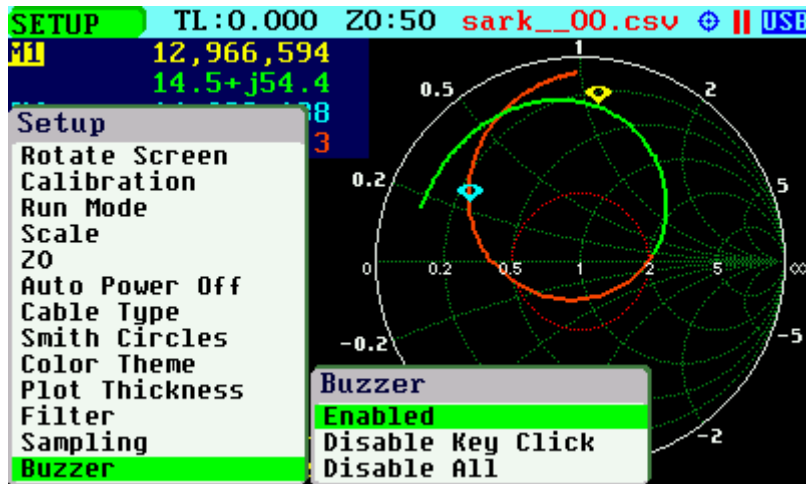

Setup – Backlight

This setup allows adjustment of the display's backlight intensity. The range is from 1 to 10, where the higher value corresponds to the higher brightness.

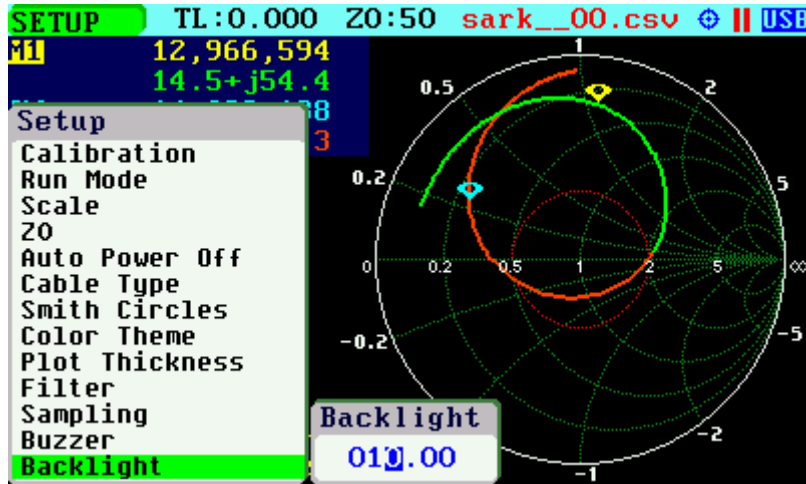

Setup – Units

This setup allows configuration of distance units either in meters or feet.

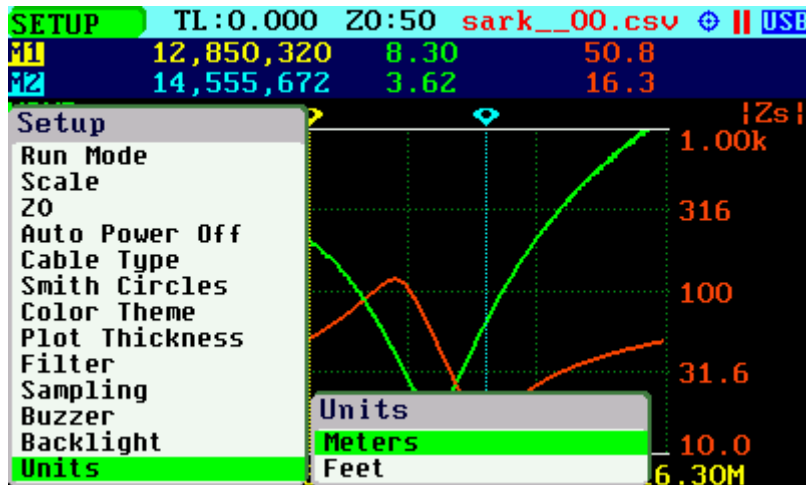

Setup – Stubs

This setup allows configuration of the fraction of wavelength and velocity factor for the tuning stubs feature; see section 4.3.



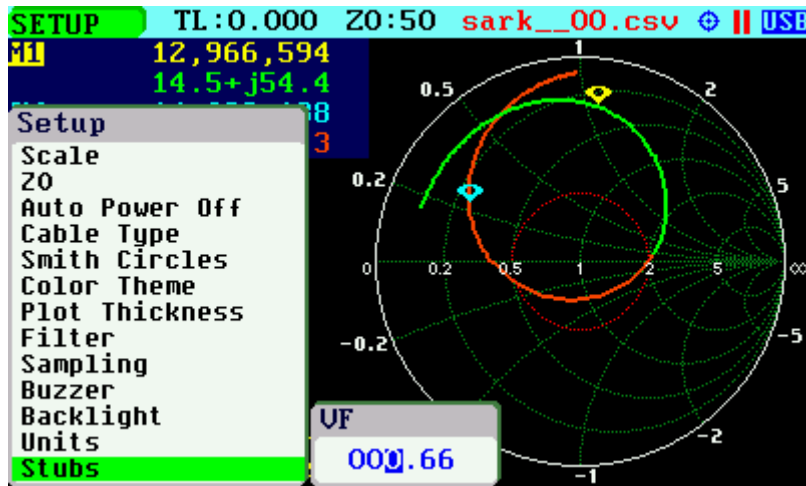

Setup – Main Menu

This setup permits enabling or disabling the main menu.

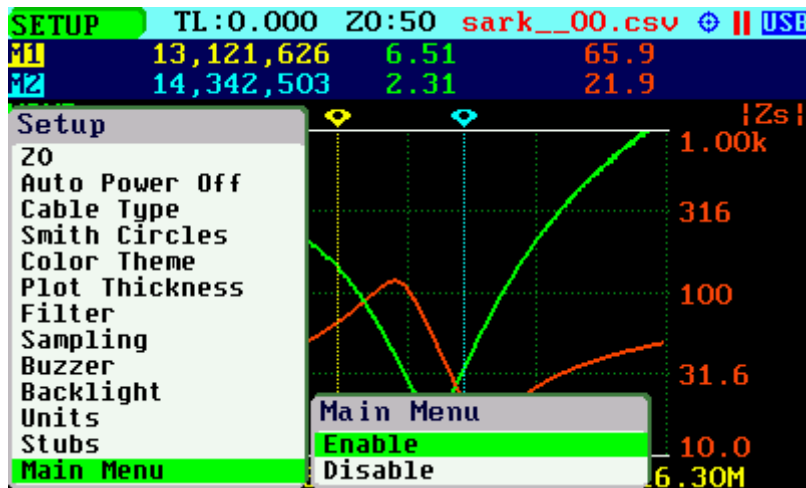

Setup – Reset to Factory Defaults

This setup permits resetting the analyzer to its default settings.

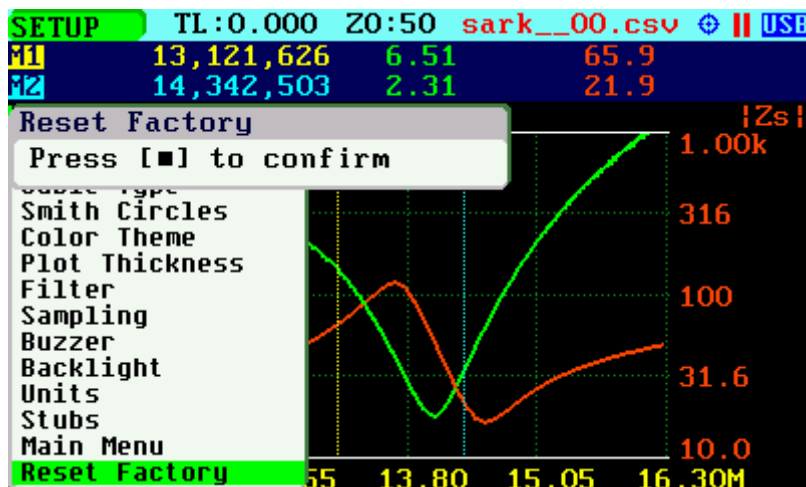

The internal disk drive can be optionally formatted. Press the Select [■] button to format the disk or any other button if only a reset to factory defaults is required.

It is recommended that the disk contents are backed up to a PC as most of the files will be lost during the format. Only the Detector Calibration file (detcalib.dat) and the file associated with the selected OSL Calibration profile are preserved.

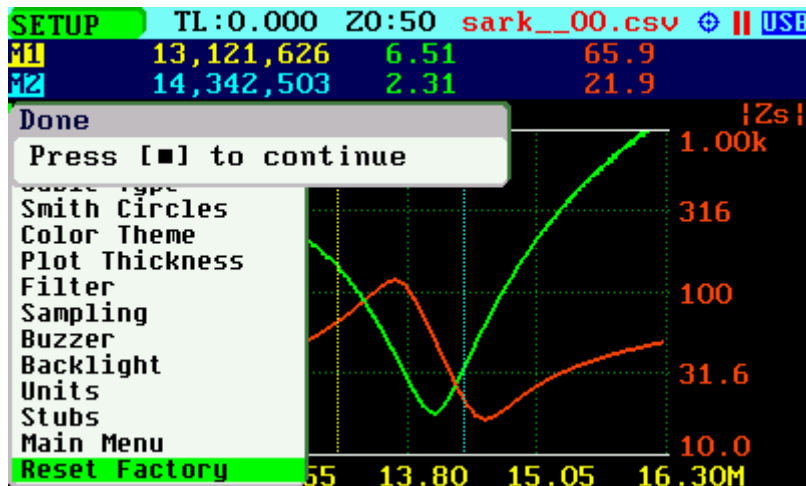

Setup – About

The About screen displays copyright information, firmware release number, disk size and free space.

```
SARK 110
antenna vector impedance analyzer
(c) Melchor Varela EA4FRB 2011-2018
SARK110-APP Ver 0.10.9
Volume Name: SARK-110 MU
1997 KB total disk space
1425 KB available on the disk
Build Date: Jan 3 2018
Compiler Ver: 4.8.3 20140228 (release) [ARM/
```

3 Operating Modes

3.1 Scalar Chart Mode



1	Diagram	9	Reference impedance setting
2	Traces	10	Calibration profile
3	Markers	11	Filter setting
4	Vertical axis labeling	12	Sampling setting
5	Frequency axis labeling	13	Calibration status
6	Active main menu option	14	Run/Hold status
7	Markers information window	15	USB/Battery status
8	Transmission Line length setting		

The Scalar Chart mode provides functionality for impedance measurements of antennas, transmission lines and RF circuits. The analyzer performs reflection measurements within a user-specified frequency range, defined by the frequency and the span. The two user-selectable fundamental parameters are displayed as a Cartesian diagram. Up to two markers can be selected to provide precise information in the plotted areas. Their positions can either be user-selected or automatically tracked. They are also useful for indicating characteristic points in the plot.

Use Navigator A to select «**MODE**» in the main menu. Press the Select [■] button to activate the Mode popup submenu and use Navigator B to highlight «*Scalar Chart*» submenu mode option. Finally press the Select [■] button to enter Scalar Chart mode.

The analyzer performs measurements and updates the plot continuously if the Run Mode in the «**SETUP**» menu is set to Continuous. The sweep can be stopped at any time by pressing the Run/Hold [▶||] button. If the Run Mode in the «**SETUP**» menu is set to Single Shot, the sweep automatically stops on completion of a single pass. Press the Run/Hold [▶||] button to start a new sweep.

The results of the measurements are kept in internal memory and plotted on the display to permit user analysis. The measurements can be resumed at any time by pressing the Run/Hold [▶||] button again. Measurement data can be stored at any time on the internal disk by pressing the Save Screen [●] button and restored later for review through different options in the «**FILE**» menu.

3.2 Smith Chart Mode

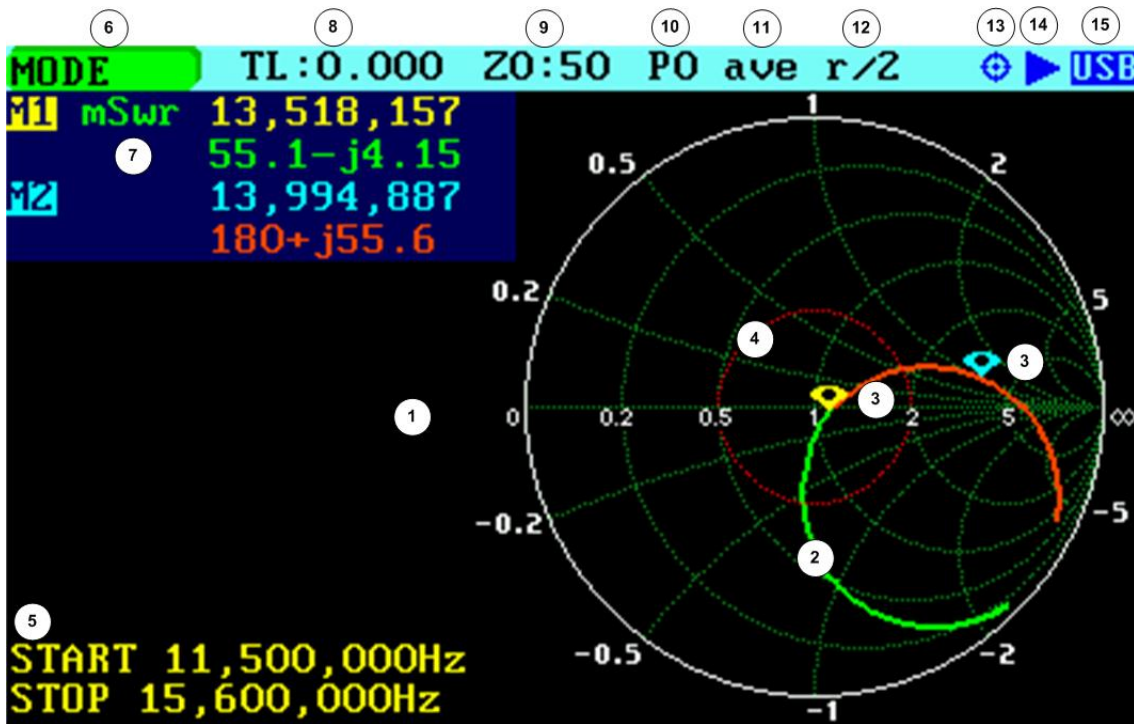

1	Diagram	9	Reference impedance setting
2	Trace	10	Calibration profile
3	Markers	11	Filter setting
4	Constant VSWR circle	12	Sampling setting
5	Frequency start and end	13	Calibration status
6	Active menu option	14	Run/Hold status
7	Markers information	15	USB/Battery status
8	Transmission Line length setting		

The Smith Chart mode is equivalent to the Scalar Chart mode but in this case the complex reflection measurements for the user-specified frequency range are displayed in a Smith Chart diagram.

Use Navigator A to select «**MODE**» in the main menu. Press the Select [■] button to activate the Mode popup submenu and use Navigator B to highlight «*Smith Chart*» submenu mode option. Finally press the Select [■] button to enter into Smith Chart mode.

The analyzer performs measurements and updates the plot continuously if the Run Mode in the «**SETUP**» menu is set to Continuous. The sweep can be stopped at any time by pressing the

Run/Hold [▶||] button. If the Run Mode in the «**SETUP**» menu is set to Single Shot, the sweep automatically stops on completion. Press the Run/Hold [▶||] button to start a new sweep.

The trace is painted in two colors: green trace shows the reflection coefficient for the frequencies below the center frequency and red trace for the frequencies above the center frequency. This allows easily identifying the position of the center frequency.

The impedance measurement data and marker positions are preserved when changing to the Scalar Chart mode and vice versa. For example, markers can be set at the zero reactance points of the plot (where the plot crosses the X axis) in the Smith Chart mode and see them in Cartesian format in the Scalar Chart mode.

There are two zoom choices available. For both options the center is unchanged and the outer circle of the chart can be specified at a VSWR of 5.0 or 2.0.

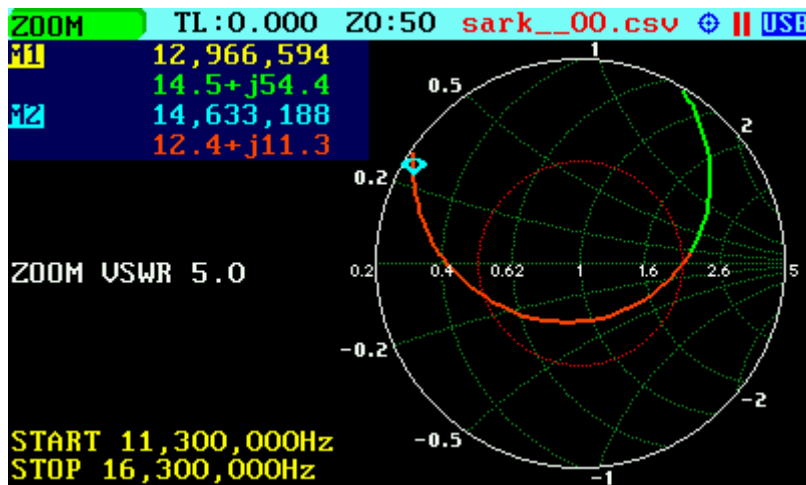
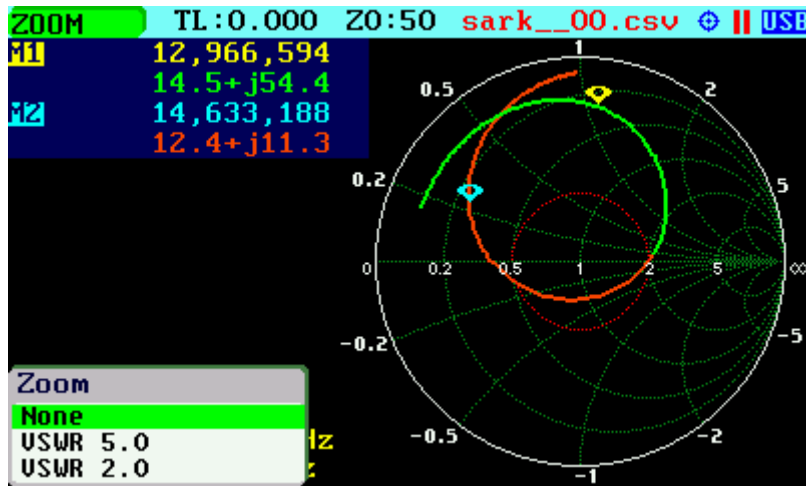

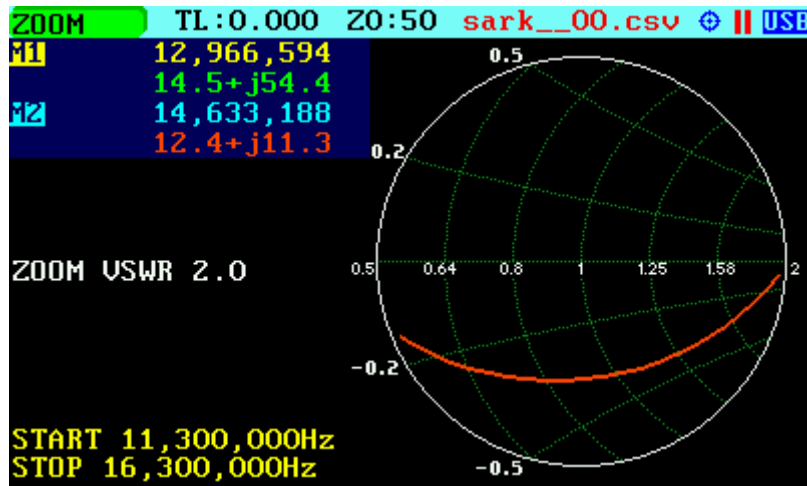

Since firmware version v0.10.9, the arrangement of the Smith chart mode changed slightly in order to display a bigger chart. Functionality and indicators have not changed.

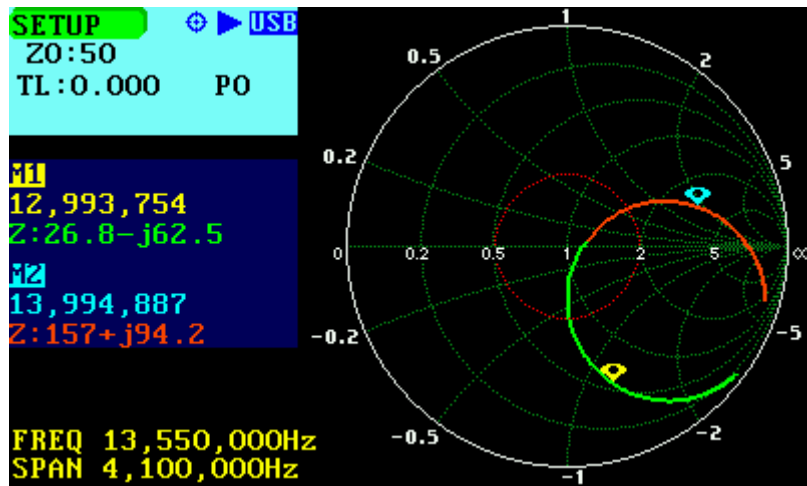

3.3 Single Frequency Mode

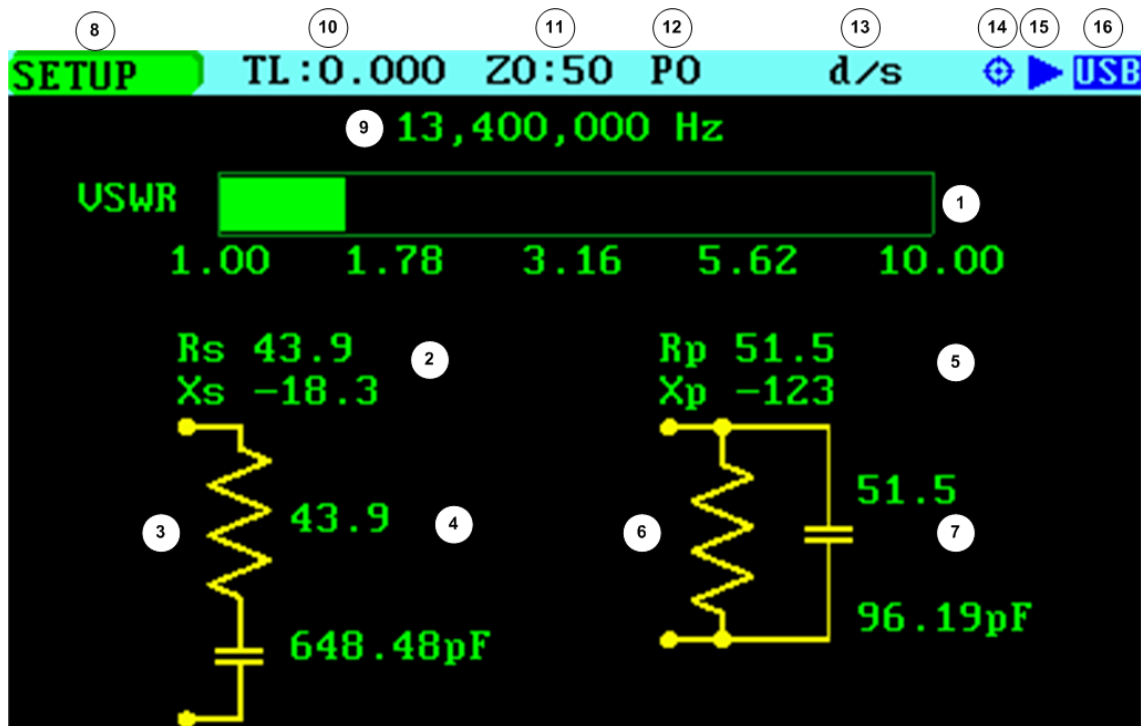

1	VSWR bar	9	Frequency setting
2	Series impedance complex form	10	Transmission Line length setting
3	Circuit equivalent series	11	Reference impedance setting
4	Series resistance and equivalent inductance (or capacitance) values	12	Calibration profile
5	Parallel impedance complex form	13	Sampling option
6	Parallel circuit equivalent	14	Calibration status
7	Parallel resistance and equivalent inductance (or capacitance) values	15	Run/Hold status
8	Active menu option	16	USB/Battery status

The Single Frequency mode provides impedance measurements at a single frequency. All the measured fundamental parameters at the selected frequency are shown in the display. In addition, a VSWR graph is available for a quick visualization of this parameter. As well as the two element equivalent circuit models, both series and parallel circuits are displayed as schematics.

Use Navigator A to select «MODE» in the main menu. Press the Select [■] button to activate the Mode popup submenu and use Navigator B to highlight «Single Frequency» submenu mode option. Finally press the Select [■] button to enter into Single Frequency mode.

The analyzer performs the measurements continuously, unless it is on hold by pressing the Run/Hold [▶||] button. The measurements can be resumed at any time by pressing the same button again.

This mode offers optional VSWR audio feedback. When activated by the menu option «AUDIO», the analyzer produces beeps of different duration as an indication of VSWR. The audio is produced only for VSWR values between 1.0 and 10.0 and the beep duration is shorter for lower values.

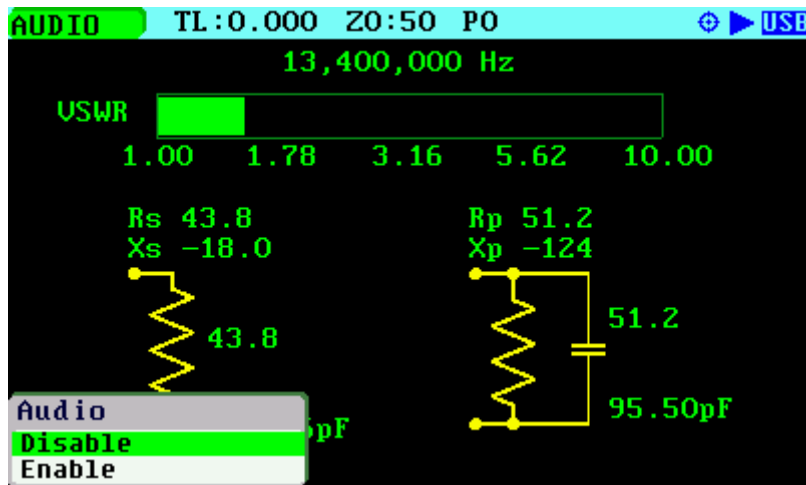

There are four presentation modes in single frequency mode.

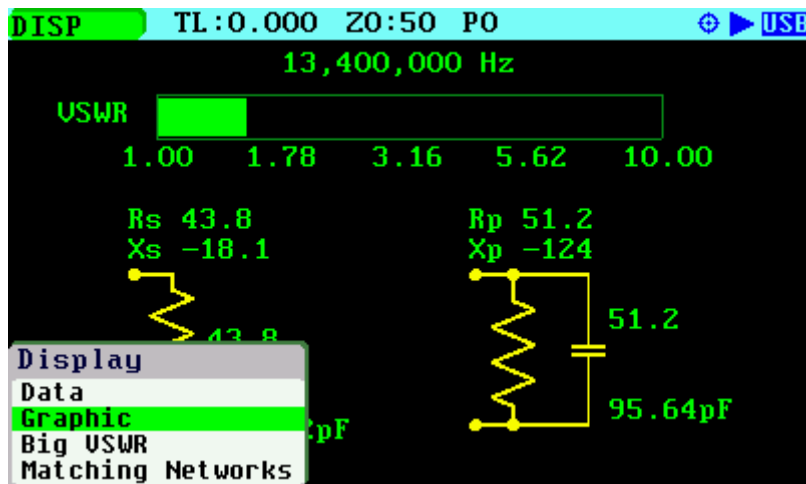

Select «DISP» «Data» for a tabulated presentation of the readings.

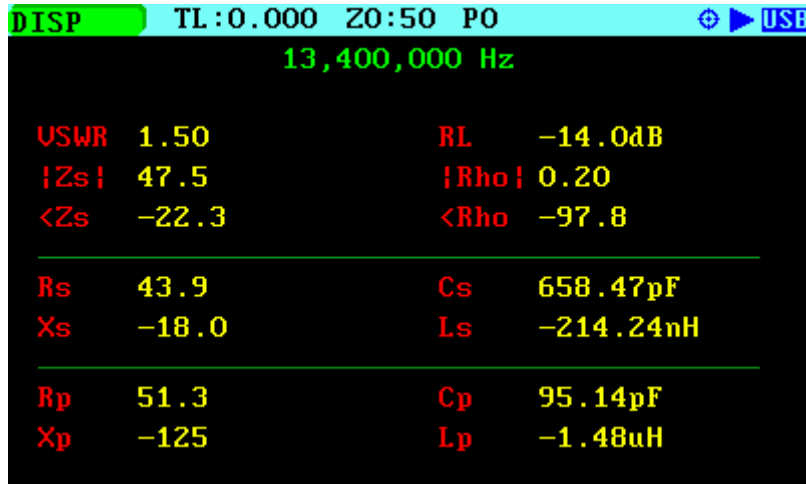

Select «DISP» «Graphic» for the graphic presentation.

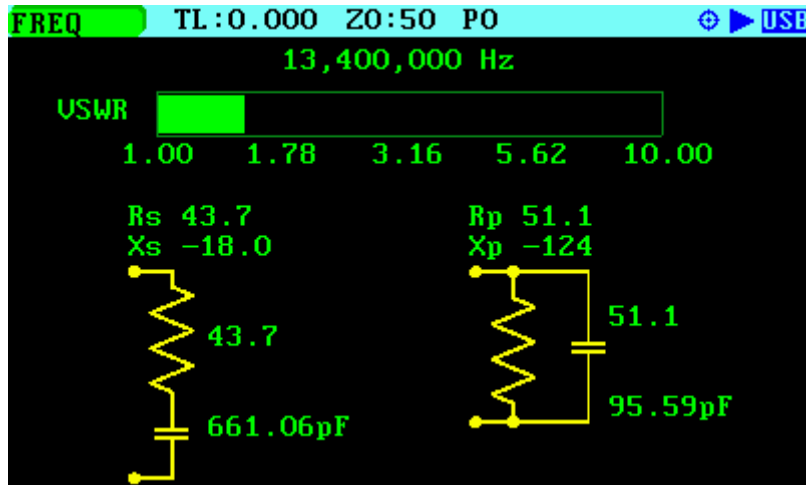

Select «DISP» «Big VSWR» for a presentation mode where the VSWR readings are displayed with a big font for easy viewing.

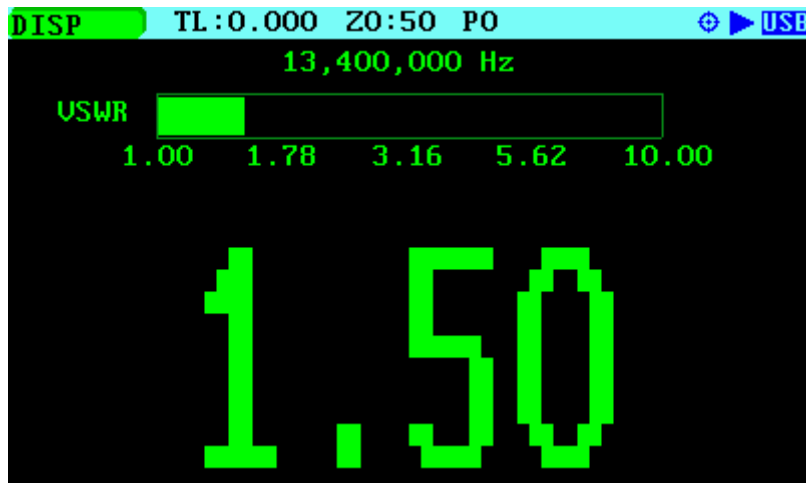

Matching Networks is another supported presentation mode. In this mode the analyzer automatically calculates the L/C values in four matching networks. Select «DISP» «Matching Networks» for this presentation mode.

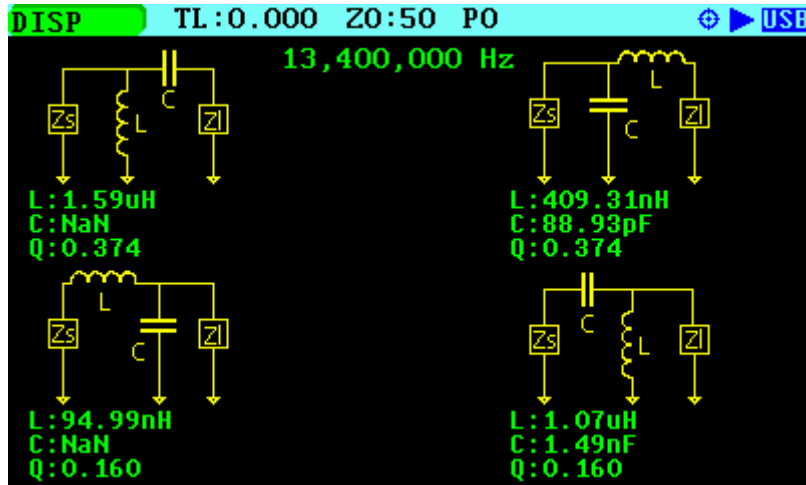

Since firmware version v0.10.4, Single Frequency mode allows taking measurements at specified time intervals that are recorded sequentially in a text file. This feature is designed for scenarios where it is necessary analyzing variations in measurements over time.

The procedure is the following:

Select «FILE» «Save Data File»

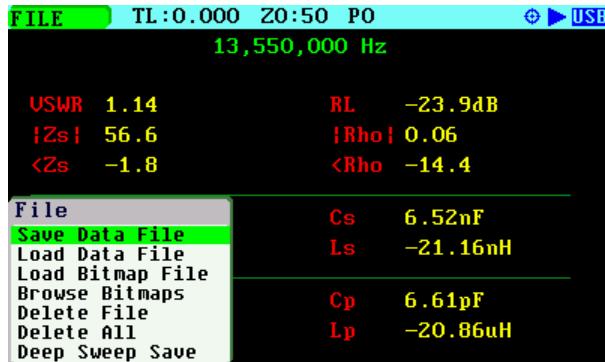

Select the file name

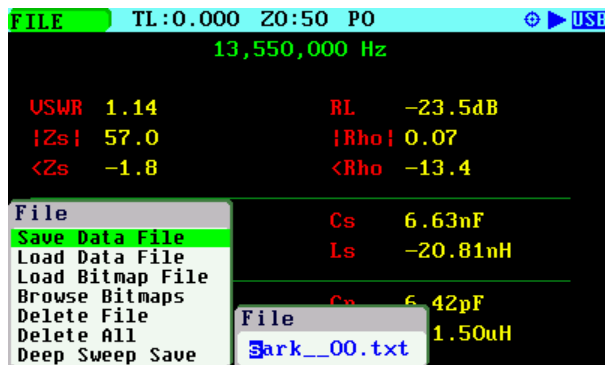

Select the sampling time in a range from 500 ms to 60000 ms

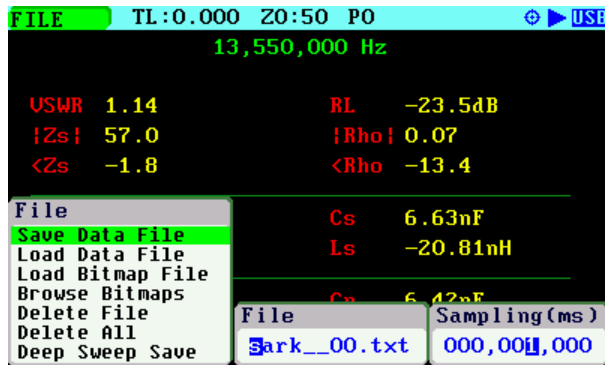

The analyzer stores the measured data at the specified interval. Number #n in the status line indicates the current record index

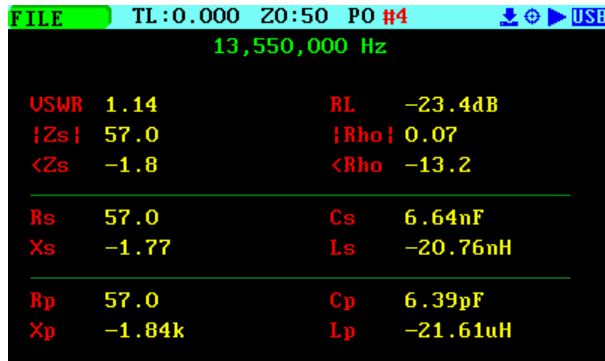

Press any button to stop the save operation

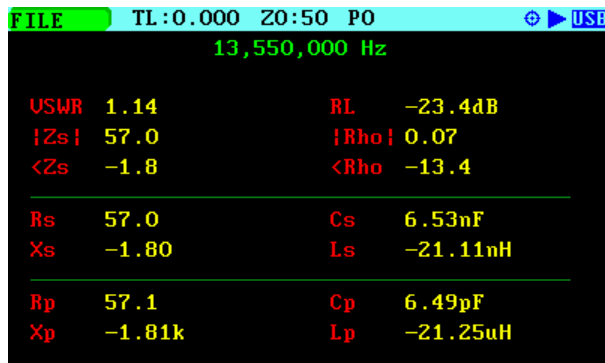

The stored data in log files includes the index, the relative time in milliseconds, the frequency and the fundamental parameters:

```
-- SARK-110 Data Log --
```

```
Z0:50.000000, TL Len:0.000000
```

```
** Start of Log **
```

```
Index,Time,Freq,VSWR,Rs,Xs,Rp,Xp,|Zs|,<Zs,RL,CL,|Rh|,<Rh,%Rp,Q,Cs,Ls,Cp,Lp
```

```
0,26615,13.550000,1.145281,57.027576,-1.778061,57.083015,-1830.818115,57.055290,-1.785845,-23.385521,11.692760,0.067721,-13.246773,0.458615,0.031179,6605.933594,-0.020885,6.415576,-21.504335
```

1,27615,13.550000,1.145240,57.034416,-1.744661,57.087784,-1866.247437,57.061092,-
1.752109,-23.387812,11.693906,0.067703,-12.995469,0.458373,0.030590,6732.399902,-
0.020492,6.293781,-21.920479

2,28615,13.550000,1.144766,57.006538,-1.757563,57.060726,-1850.764648,57.033627,-
1.765921,-23.414286,11.707143,0.067497,-13.140868,0.455587,0.030831,6682.978516,-
0.020644,6.346432,-21.738623

** End of Log **

3.4 Cable Test Mode (TDR)

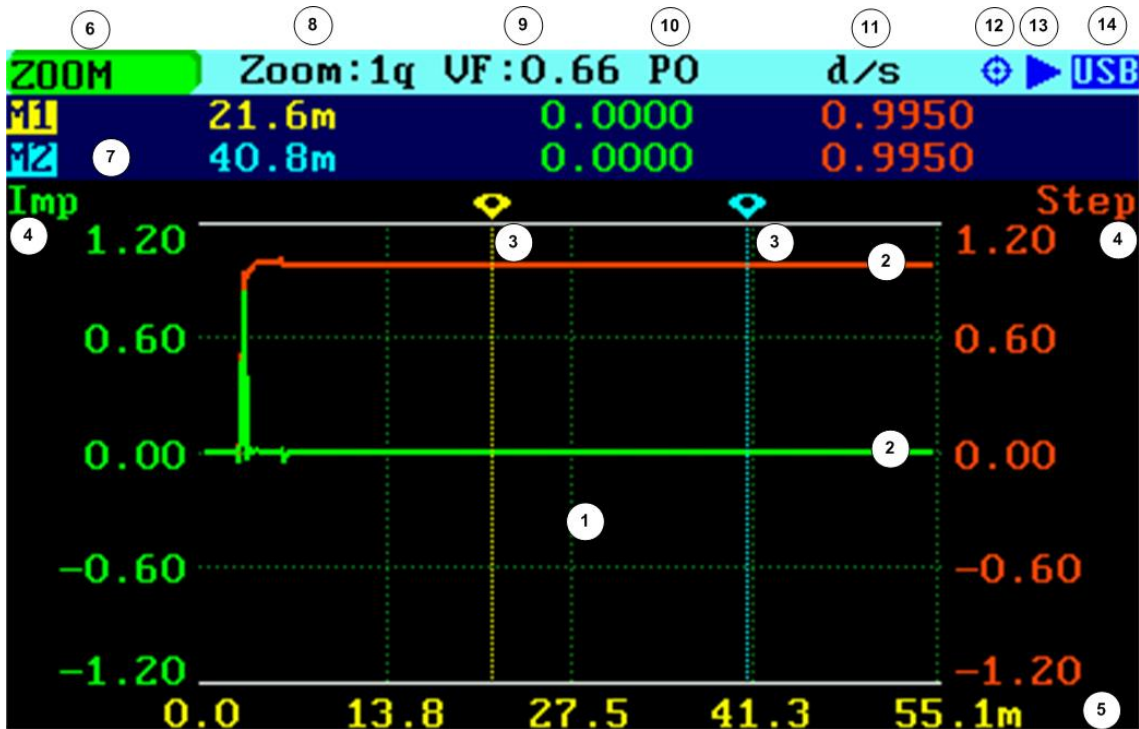

1	Diagram	8	Zoom mode
2	Traces	9	Cable Velocity Factor Setting
3	Markers	10	Calibration profile
4	Vertical axis labeling	11	Sampling option
5	Distance axis labeling	12	Calibration status
6	Active menu option	13	Run/Hold status
7	Markers information	14	USB/Battery status

Cable Test or Time Domain Reflectometer (TDR) mode is intended to identify potential coaxial cable faults that could disrupt signal transmission. Unlike native TDR test equipment, the method of measurement in the SARK-110 is based on the theory of Frequency Domain Reflectometry (FDR).

The analyzer makes swept reflection measurements over the entire frequency range and mathematically transforms the gathered data to Time Domain using an inverse Fourier transform. As a result, the step and impulse responses are plotted on the display, providing information about the location and the nature of any fault. The impulse response trace (green trace) gives an indication of the fault location. The step response trace (red trace) provides an indication of the nature of the fault.

The vertical axis of the graph displays the reflection coefficient: Rho = -1 for short load, 0 for matched impedance load ($Z_{Load} = Z_0$), or Rho = +1 for open load. The horizontal axis displays the distance in meters.

Use Navigator A to select «MODE» in the main menu. Press the Select [■] button to activate the Mode popup submenu and use Navigator B to highlight the «Cable Test» submenu mode option. Finally press the Select [■] button to enter into Cable Test mode.

This measurement requires the user to select the cable's characteristic impedance and velocity factor. These settings are obtained from the selected cable in the «SETUP» «Cable Type» menu option.

As in the other modes, the measurements can be performed continuously or in single shot mode and controlled by the Run/Hold [▶||] button, but in this case it takes some seconds for the results to show on the display due to the time it takes to make a full frequency sweep.

The distance from the start of the cable to any discontinuity may be found by moving one of the markers over the discontinuity of interest. The distance of the fault from the start of the cable is then shown in that marker's distance figure.

There is a basic zoom feature controllable from the «ZOOM» menu option. This allows zooming into one of the four quarters of the graph or the complete span via the option «Extends». Also available is a zoom option to extend the first octave and the first sixteenth of the graph for short cable lengths.

See in the screenshots below the operation of the zoom function in which the measurement of a coaxial cable line of 27.3 meters and Velocity Factor of 0.66 in open condition (unterminated at the other end) is shown below:

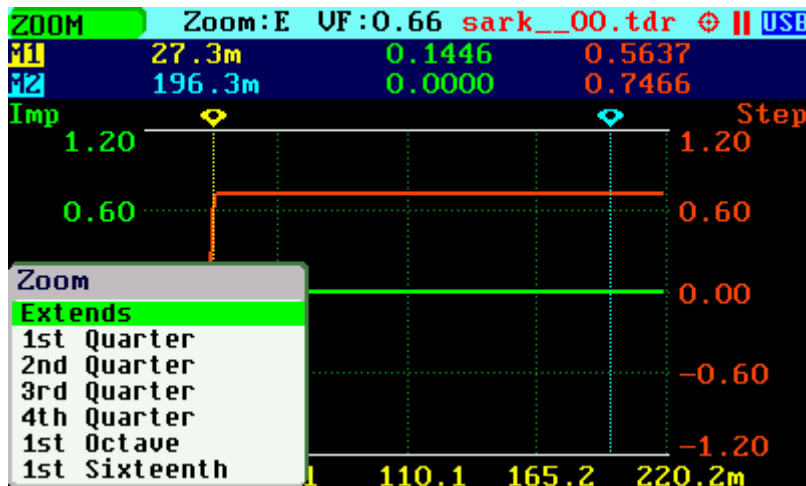

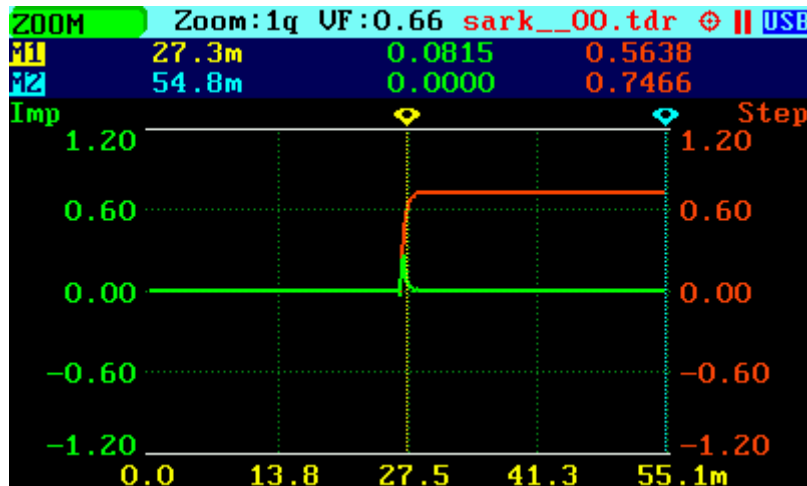

Figures below illustrate the responses of known discontinuities:

Element	Impulse Response	Step Response	Display
Open	 Unity reflection	 Unity reflection	
Short	 Unity reflection, -180°	 Unity reflection, -180°	
Resistance $R > Z_0$	 Positive peak	 Positive level shift	
Resistance $R < Z_0$	 Negative peak	 Negative level shift	
Inductance	 Positive then negative peaks	 Positive peak	
Capacitance	 Negative then positive peaks	 Negative peak	

3.5 Field Mode

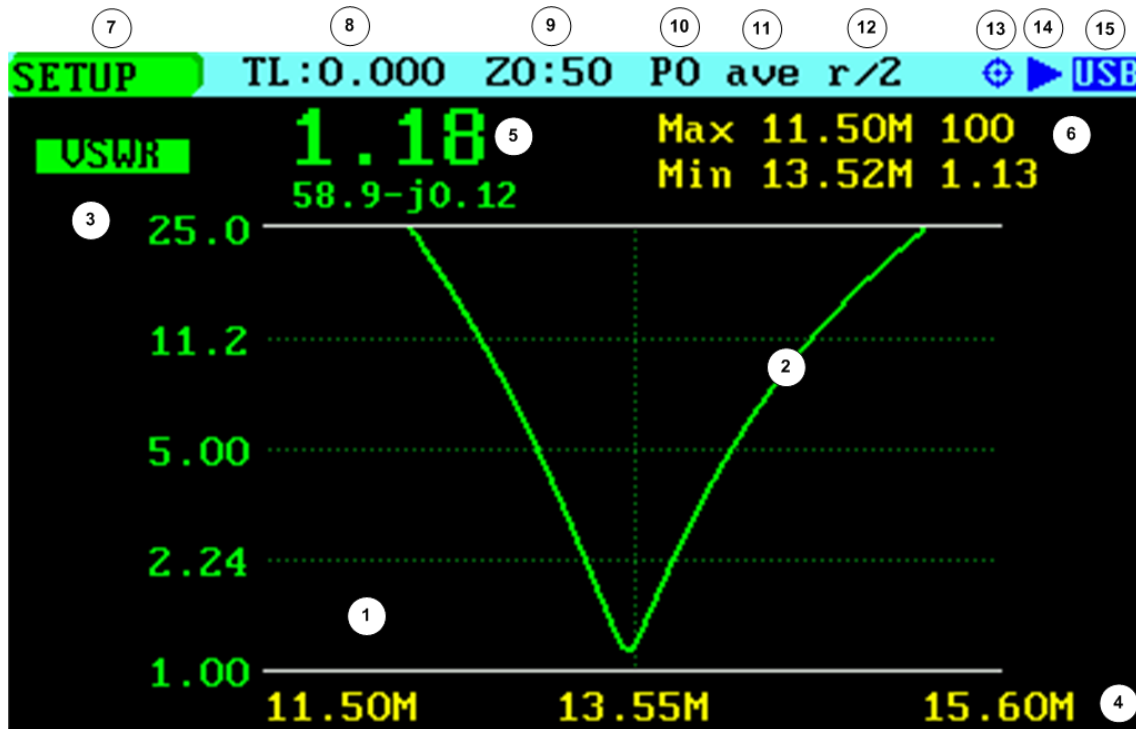

1	Diagram	9	Reference impedance setting
2	Trace	10	Calibration profile
3	Vertical axis labeling	11	Filter setting
4	Frequency axis labeling	12	Sampling setting
5	Reading (value and Z) at the center frequency	13	Calibration status
6	Maximum and minimum values	14	Run/Hold status
7	Active menu option	15	USB/Battery status
8	Transmission Line length setting		

Field Mode is equivalent to the Scalar Chart mode but simpler to use and with a more legible presentation aimed at operation in the field. The reading at the center frequency is shown using a bigger font. Frequency and magnitude of maximum and minimum points in the trace are shown at the top of the graph. This will be helpful, for instance, in the identification of the frequency and magnitude of the minimum VSWR point.

Use Navigator A to select «**MODE**» in the main menu. Press the Select [■] button to activate the Mode popup submenu and use Navigator B to highlight «*Field*» submenu mode option. Finally press the Select [■] button to enter into Field mode.

Operation is similar to the scalar chart mode with some limitations such as only one trace is plotted and the markers feature is not available.

3.6 Multi-band Mode

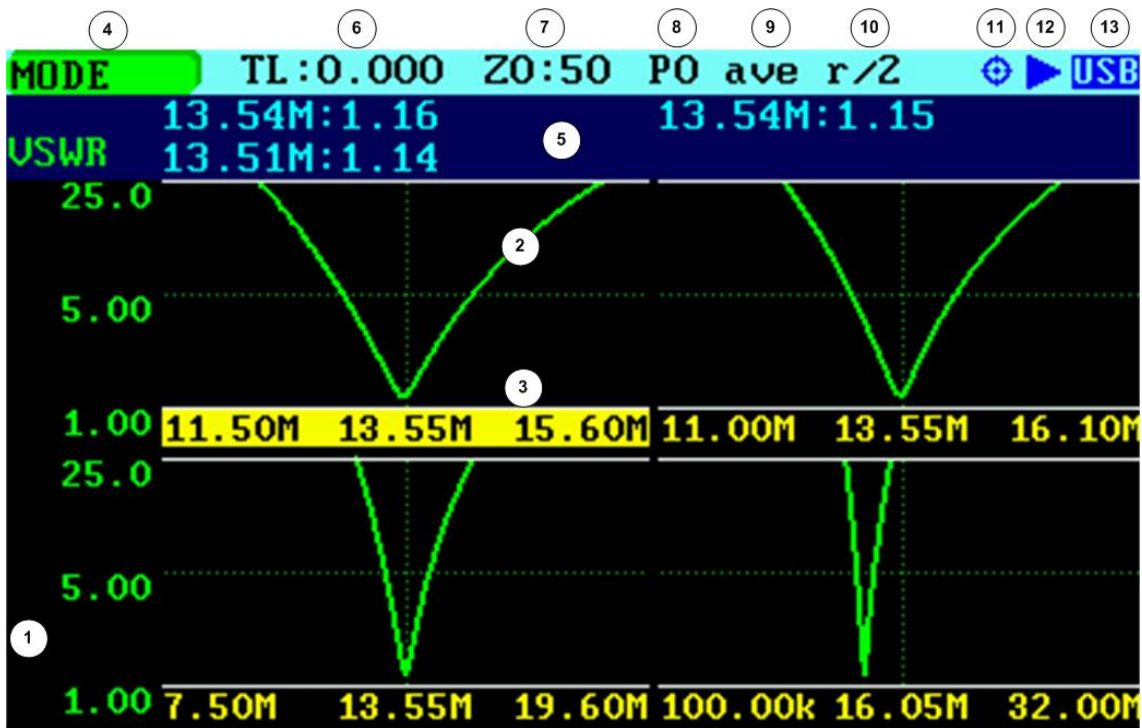

1	Diagrams	8	Calibration profile
2	Trace	9	Filter setting
3	Selected band	10	Sampling setting
4	Active menu option	11	Calibration status
5	Frequency and magnitude value for each band	12	Run/Hold status
6	Transmission Line length setting	13	USB/Battery status
7	Reference impedance setting		

The Multiband mode is a unique feature of the SARK-110 to display the plot of an impedance parameter in four scalar charts simultaneously. This feature is ideal for tuning multiband antennas. Additionally, it can be used to display different views of the same band, as a kind of zoom feature.

Use Navigator A to select «MODE» in the main menu. Press the Select [■] button to activate the Mode popup submenu and use Navigator B to highlight «Multi-band» submenu mode option. Finally press the Select [■] button to enter into Multi-band mode.

Operation is similar to the scalar chart mode but with some limitations such as unavailability of markers and a single trace only.

The main menu «**BAND**» option permits selecting the active band. The selected band is highlighted in the frequency axis of the band graph. Frequency and span settings are applied to the selected band. The detailed measurements at the top of the screen correspond to the selected band as well.

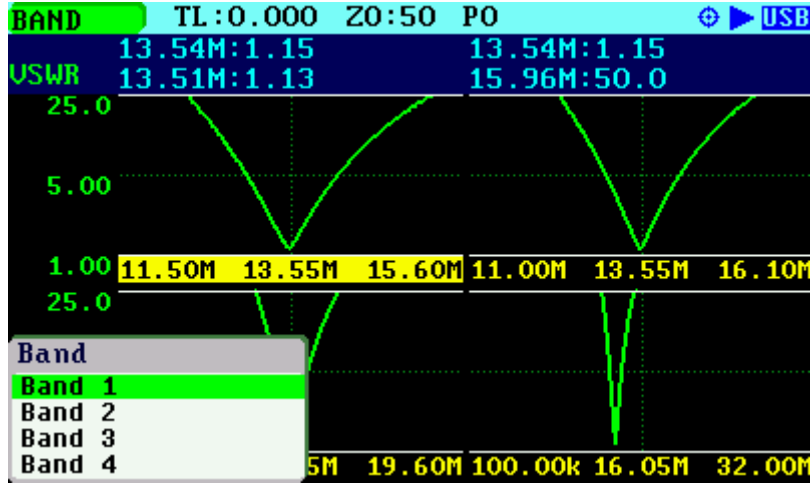

The «**CHART**» menu option allows enabling or disabling specific charts. The screenshots below show the Band 4 disabled.

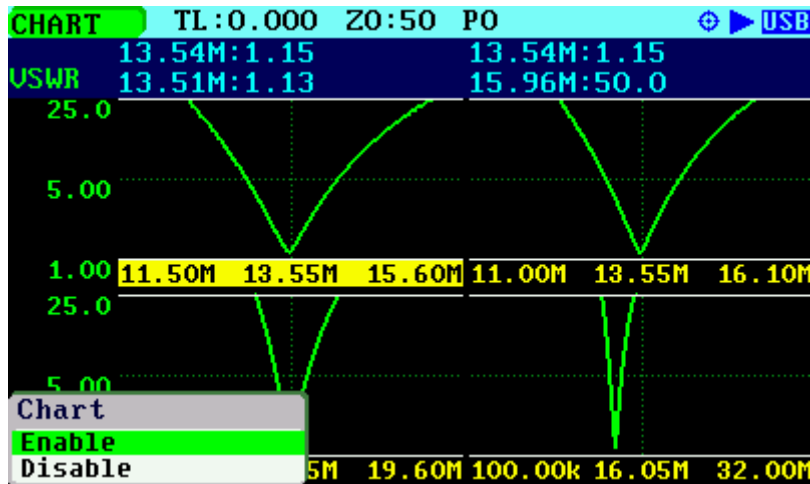

The «*Save Data File*» function operates in the same way as in other modes. The data for each band of the enabled charts is stored sequentially in individual files. The «*Load Data File*» loads the data from a file to the selected band only.

3.7 Signal Generator Mode

The SARK-110 can be used as a programmable RF signal source in Signal Generator Mode. It outputs a sinusoidal RF signal at a frequency programmable from 1 kHz to 230 MHz with eight user selectable amplitude levels ranging from -73 dBm to -10 dBm. In addition, frequency sweeps can be programmed with linear, bi-linear, logarithmic, or bi-logarithmic functions. Additionally, the signal may be modulated in FM and AM modes.

This signal generator mode is ideal for receiver testing and alignment, sensitivity tests, RF signal tracing and troubleshooting.

Use Navigator A to select «**MODE**» in the main menu. Press the Select [■] button to activate the Mode popup submenu and use Navigator B to highlight «*Signal Generator*» submenu mode option. Finally press the Select [■] button to enter into Signal Generator mode.

The screenshot below shows the signal generator screen in continuous frequency operation mode. The screen includes the programmed frequency in Hertz and the output power level expressed both in dBm and volts.

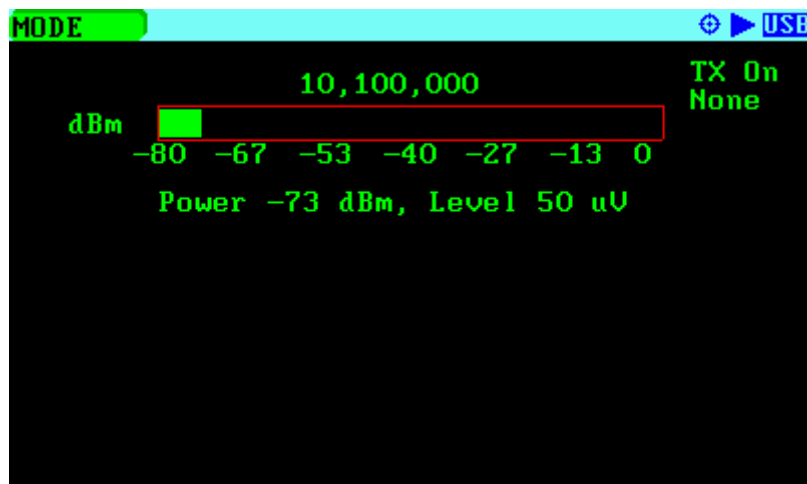

Frequency can be changed as usual; see chapter 2.5.

For changing the output level, Use Navigator A to select «**LEVEL**» in the main menu. Use Navigator B to select the desired level or press the Select [■] button to activate the level selection pop up dialog.

There are eight selectable output levels ranging from -73 dBm to -10 dBm. The «*Maximum*» output level setting produces the device's maximum output signal level that the hardware can support at the assigned frequency. Note that when using this setting there is both a more noticeable amplitude roll off with frequency as well as higher distortion of the output signal.

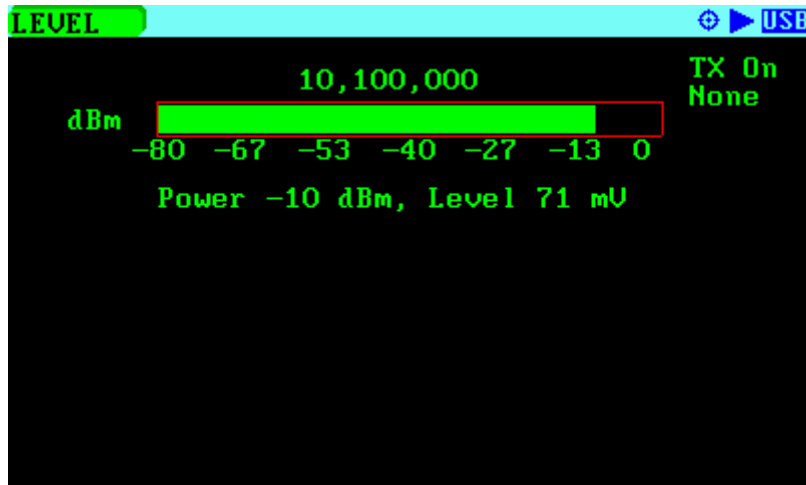
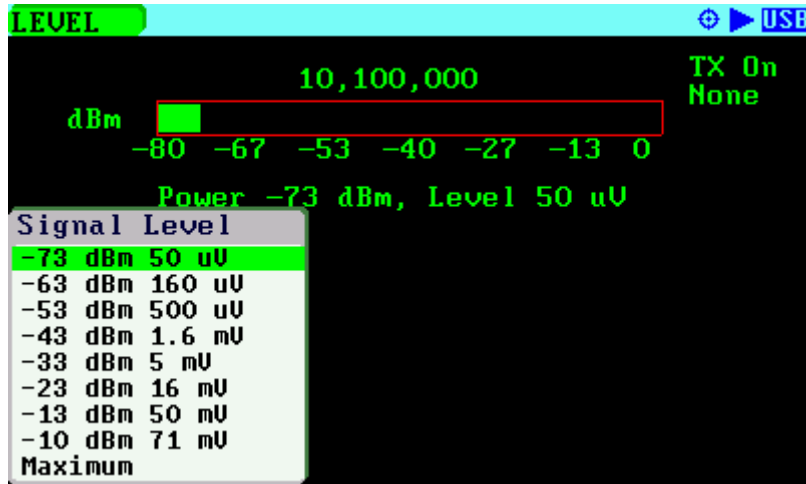

The signal generator outputs continuously unless it is on hold by pressing the Run/Hold [▶||] button. In the Hold state the level graph and power level indicators change to red. Signal generation can be resumed at any time by pressing the Run/Hold [▶||] button again.

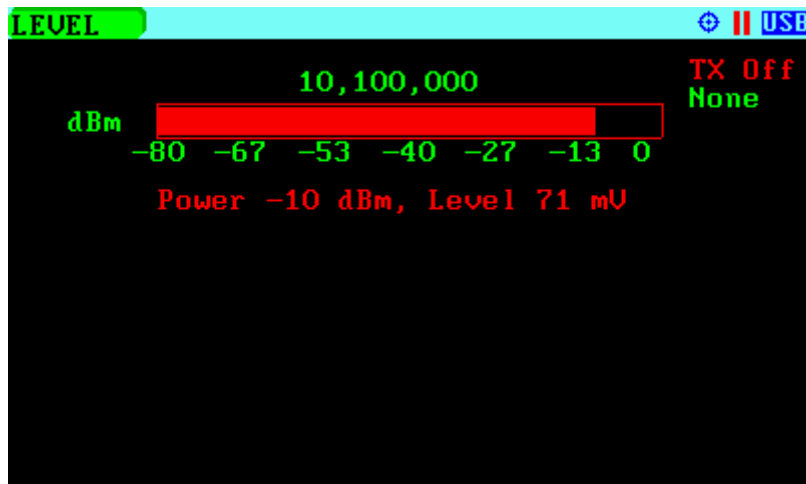

In frequency sweep mode the signal frequency will sweep between two user-defined frequencies. To change the sweep parameters, Use Navigator A to select «SWEEP» in the main menu and press the Select [■] button to validate the different sweep parameters.

The following parameters should be supplied:

- Sweep:
 - None *Continuous frequency mode*
 - Frequency *Sweep frequency mode*
- Repeat:
 - Continuous *Continuous signal generation*
 - Single *Signal generator stops after a single sweep*
 - Count: *Signal generator stops when number of sweeps reach count*
 - <Count>
- Function:
 - Linear *Linear frequency increase or decrease*
 - Log *Logarithmic frequency increase or decrease*
 - Bi-Linear *Start-Stop-Stop-Start sweep (Linear)*
 - Bi-Log *Start-Stop-Stop-Start sweep (Log)*
- Start Frequency:
 - <Start> *Hertz*
- Stop Frequency:
 - <Stop> *Hertz*
- Number of points: *Number of steps between start and stop frequency*
 - <Points>
- Delay uS: *Step time*
 - <Delay uS> *Micro-seconds*

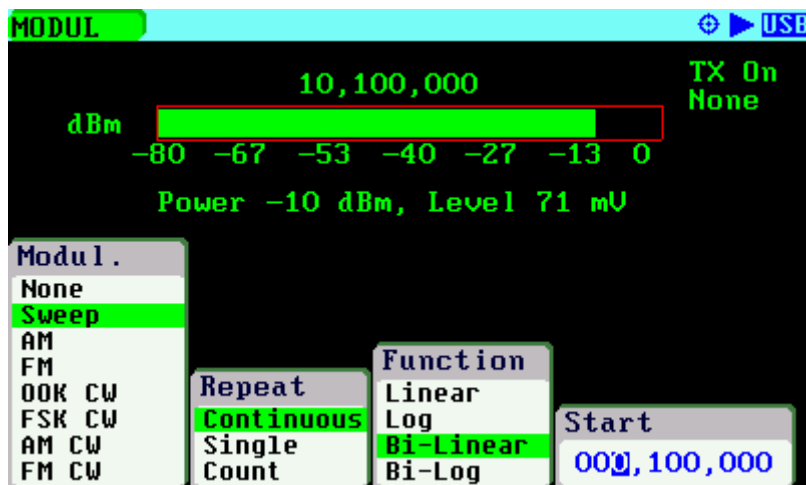

All the sweep parameters are shown on the screen as seen in the screenshot below:

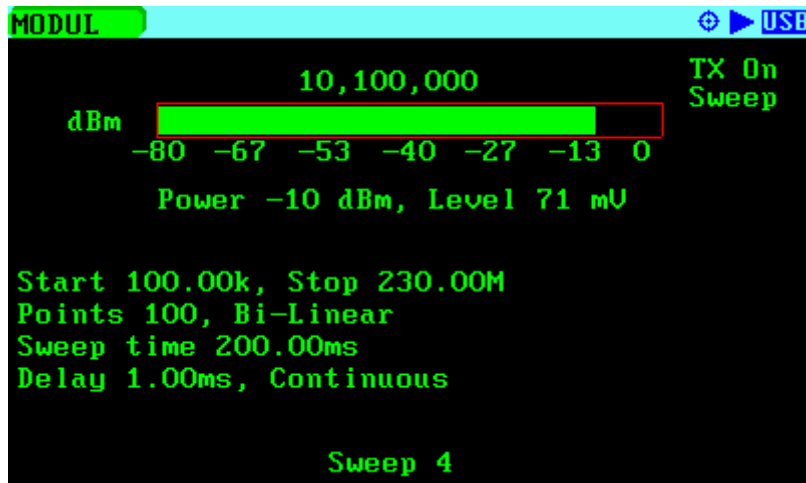

In Amplitude Modulation mode the signal is 50% modulated with a 1 kHz tone. In Frequency Modulation mode the tone frequency is 1 kHz and the frequency deviation is 2.5 kHz.

Since firmware version v0.10.5, the Signal Generator mode supports a reception mode that can be used measuring the power level of an input signal. Select «MODUL» «RX Mode» for enabling the reception mode and then the desired bandwidth. The power level is shown as a bar chart and in text format.

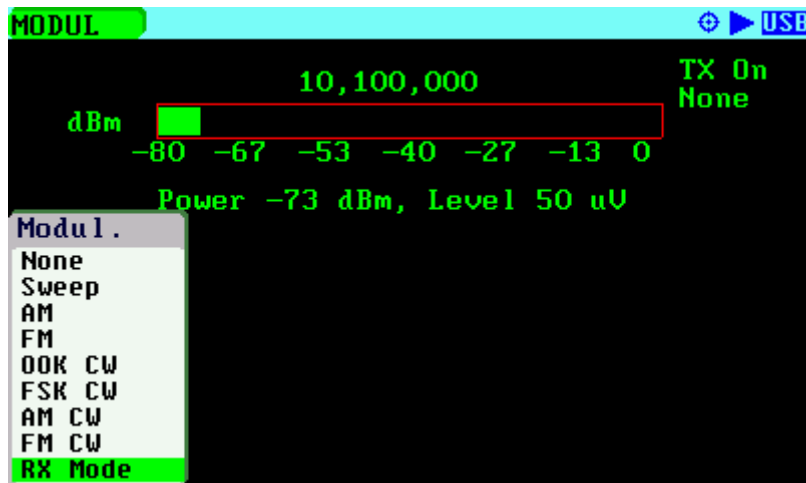

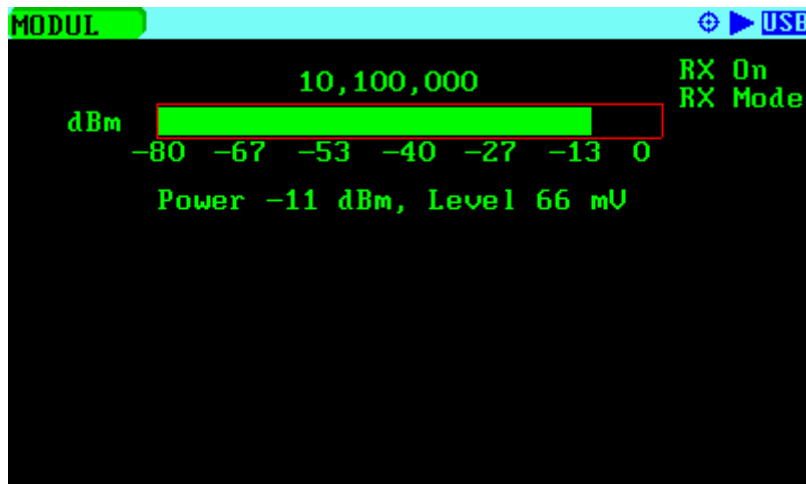
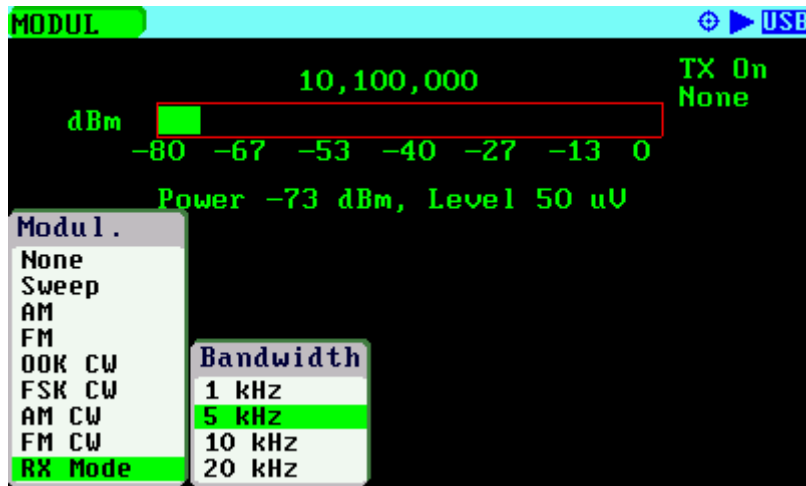

3.8 Computer Control Mode

The SARK-110 can be operated from a personal computer using SARK Plots client software for Windows, further enhancing the capabilities of the instrument. There is no need to install a dedicated driver since communication is implemented using the standard USB HID interface.

Use Navigator A to select «MODE» in the main menu. Press the Select [■] button to activate the Mode popup submenu and use Navigator B to highlight «Computer Control» submenu mode option. Finally press the Select [■] button to enter into Computer Control mode.

The analyzer establishes the USB link when it is connected to a personal computer but only accepts commands from the client in Computer Control mode.

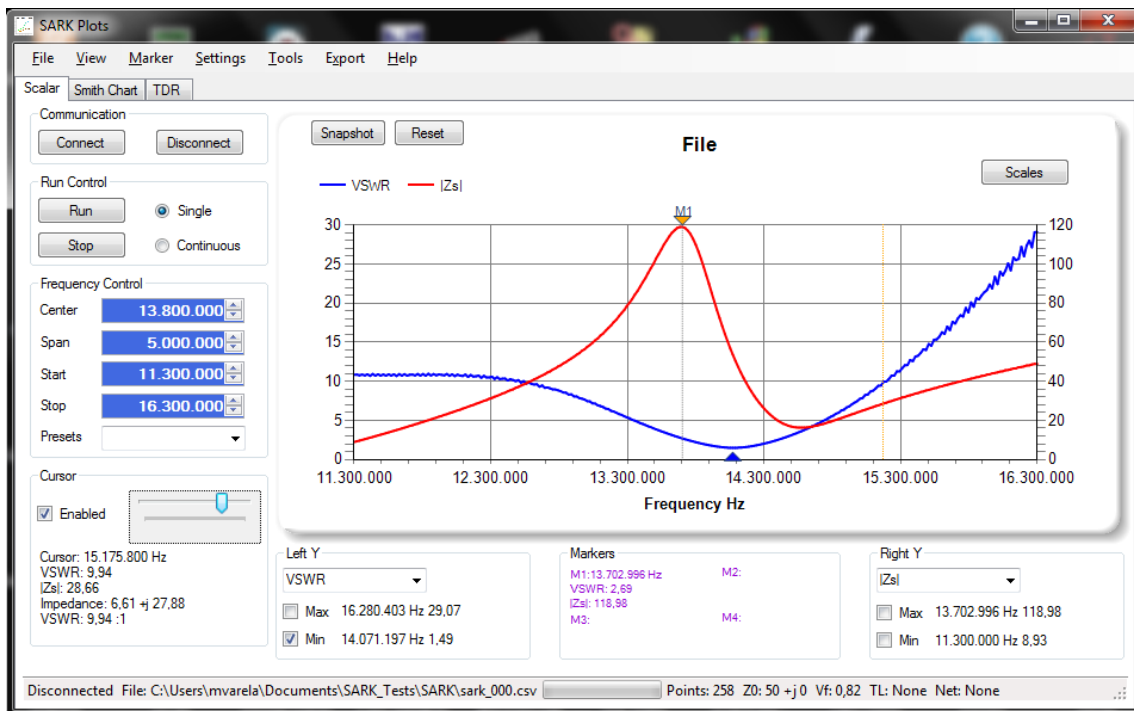

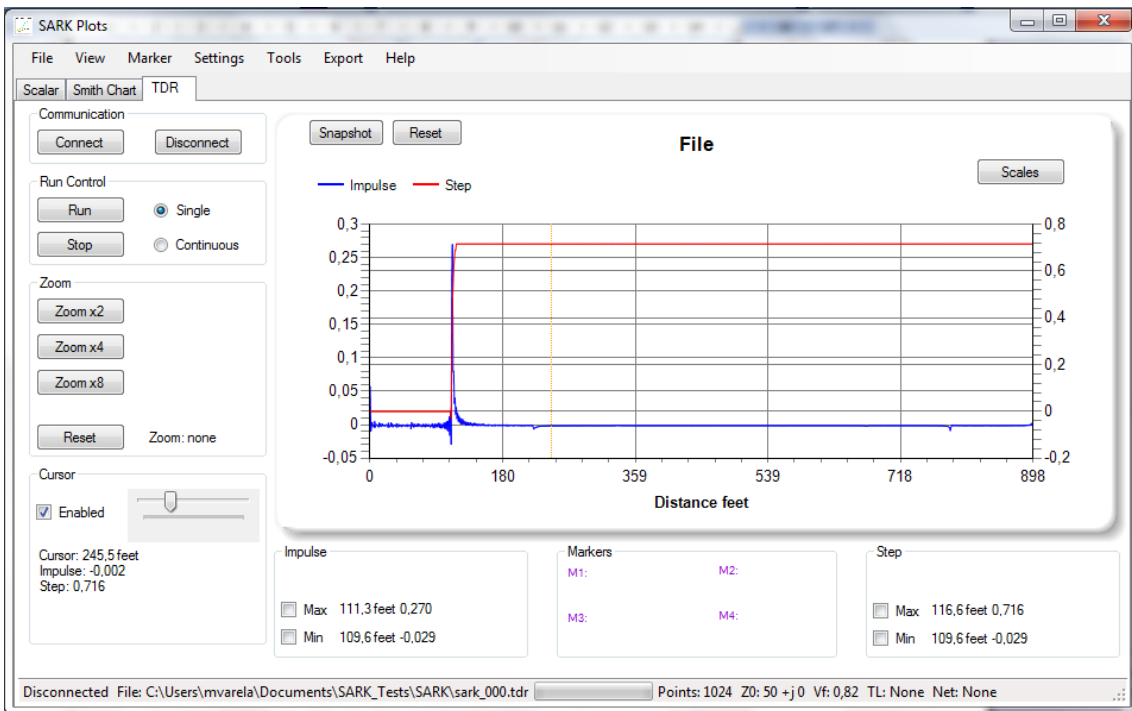
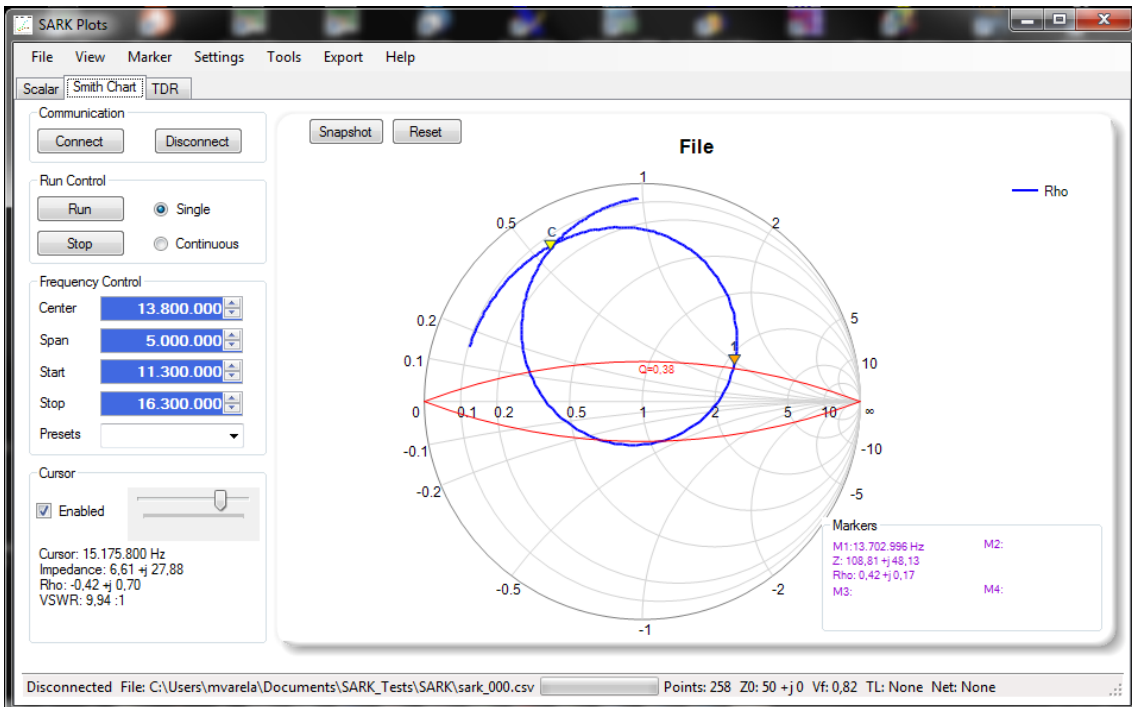

The command interface specification is open for anyone wishing to develop client software. Source code examples of the communication interface are available for different operating systems.

This information is available at the following link: <http://www.sark110.com/commands-interface>

3.9 Band Scan Mode

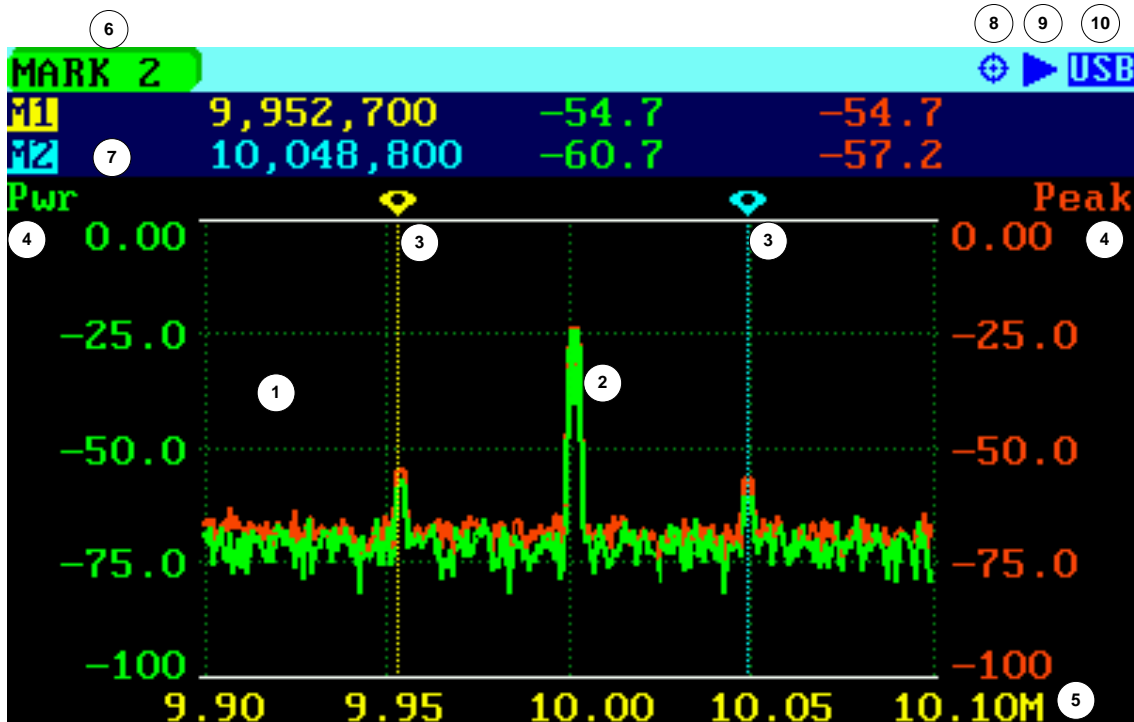

1	Diagram	6	Active menu option
2	Traces	7	Markers information
3	Markers	8	Calibration status
4	Vertical axis labeling	9	Run/Hold status
5	Frequency axis labeling	10	USB/Battery status

The SARK-110 can be used as a rudimentary Spectrum Analyzer in Band Scan Mode. It can be used to scan for nearby signals that may interfere with the measurements or to measure the power of the spectrum of signals in a lab environment.

Operation is similar to the Scalar Mode. There are two traces: left axis shows the signal power level (Pwr) and right axis shows the peak hold (Peak). Press the Run/Hold [▶||] button twice to reset the Peak trace at any time.

The sweep speed is slower than in other modes and is largely proportional to the width of the Span setting. Narrower spans yield faster sweeps.

Save Data and Load Data file operations are not available in this mode, but it is possible to capture screenshots as in the other modes.

The SARK-110 was not designed as a Spectrum Analyzer so there are a number of limitations when used for this function, such as:

- The power level is not calibrated so the measured power levels are not necessarily accurate.
- The input mixer has no image suppression, so on narrow spans, the image will appear at an equal amplitude, see the next screenshot

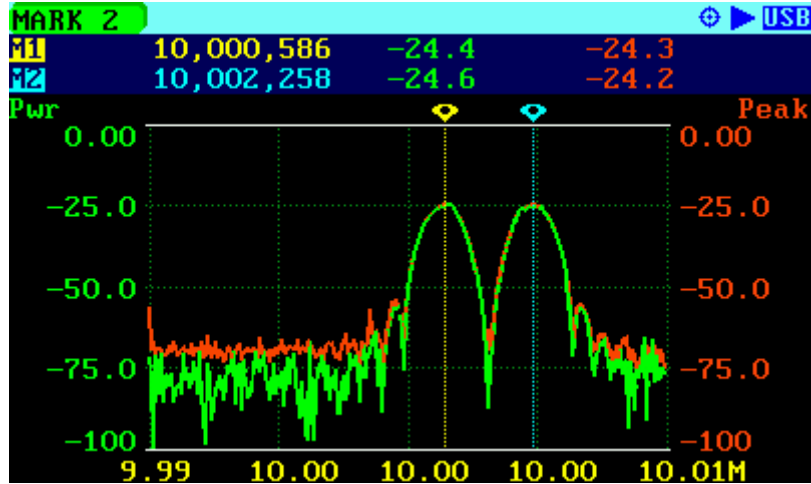

4 Special Functions

4.1 Transmission Line Add/Subtract

The SARK-110 provides the capability of subtracting a length of transmission line (transpose to load) or adding a length of transmission line (transpose to input). Use the subtraction feature to discount the effect of the feed line so the measurements will be as if the analyzer were connected at the antenna feed point. Use the addition feature for simulating the effect of a feed line.

The transmission line type has to be known in advance. The SARK-110 provides a comprehensive list of cable types and in addition the user can specify up to three custom cable types. The selection of the cable is available in the menu «**SETUP**» «*Cable Type*», see the screenshot below:

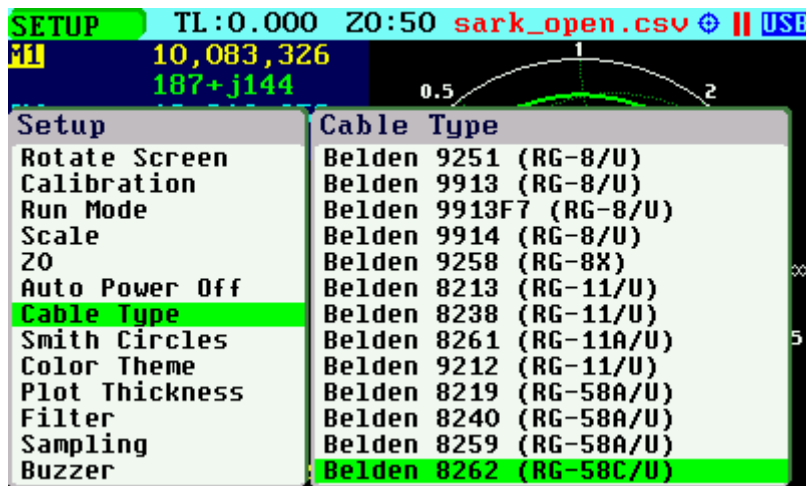

The transmission line length has to be entered into the «**TL LEN**» menu option within the Main menu. Use negative quantities for Subtract operations (transpose to load) and positive quantities for Add operations (transpose to input).

The pop-up edit dialog is activated by pressing the Select [■] button when the «**TL LEN**» option is active; see the screenshot below. The value is set by using Navigator B to adjust the digit at each of the current length multiplier positions, shown in reverse video. The length multiplier position can be changed using Navigator A. The length is validated by pressing the Select [■] button. The setting is cancelled by pressing any other button. Note that the length value can be set to zero by pressing the Save Screen [●] button

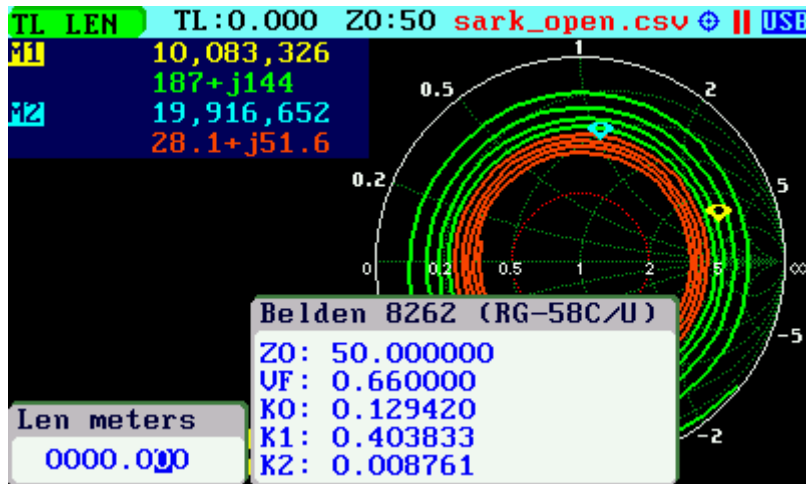

The second method for changing the transmission length is simply by using Navigator B when the «TL LEN» menu option is active. The length value will change according the current length multiplier. The length multiplier can be changed from the pop-up transmission line length edit dialog.

Since the precise cable length is not normally known in advance, there is a procedure to get the cable length as follows. As a precondition the cable must be unterminated at the far end. Set the SARK-110 to Smith Chart mode and select «PRESET» «Full HF». The Smith Chart will show a spiral from infinite impedance and going towards the center. When setting negative length values, this spiral will be progressively unrolled and transposed to the infinite impedance point when the exact length will be set. Then, if a load is connected at the cable far end, the presence of the transmission line will be discounted.

The screenshots below show an example of this in operation. A line of 28.2m of RG-58C/U coax cable is unterminated at the far end. The first screenshot shows the measurement without applying the TL compensation and the last screenshot shows the measurement once the subtract feature has been applied.

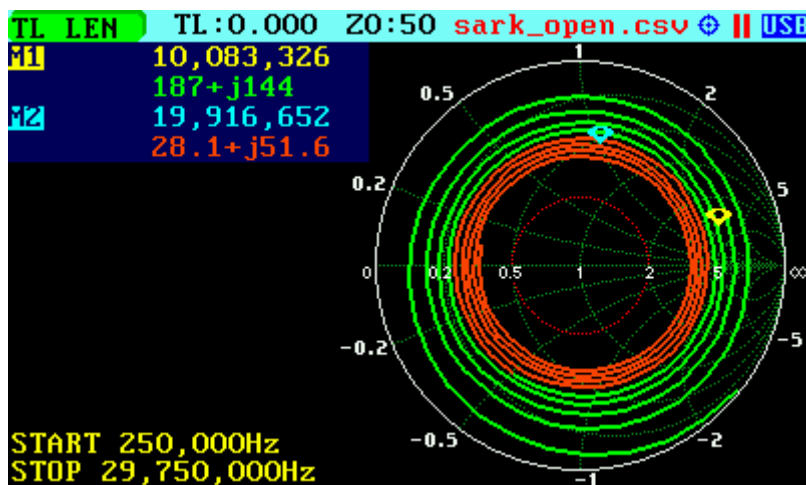

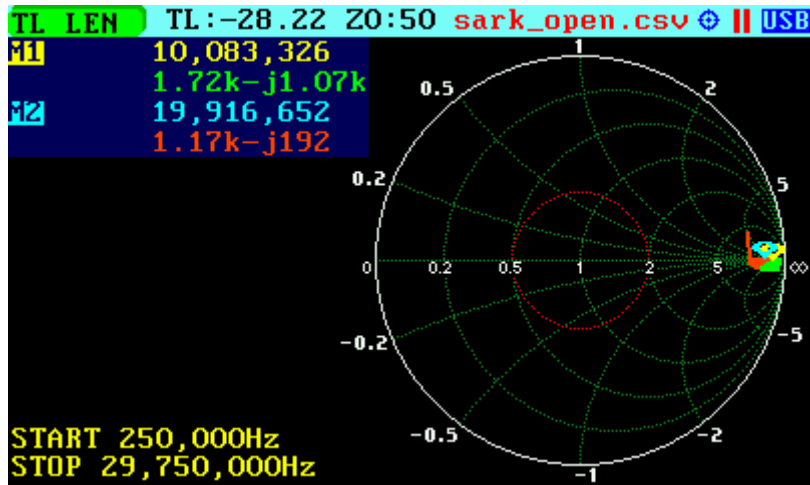
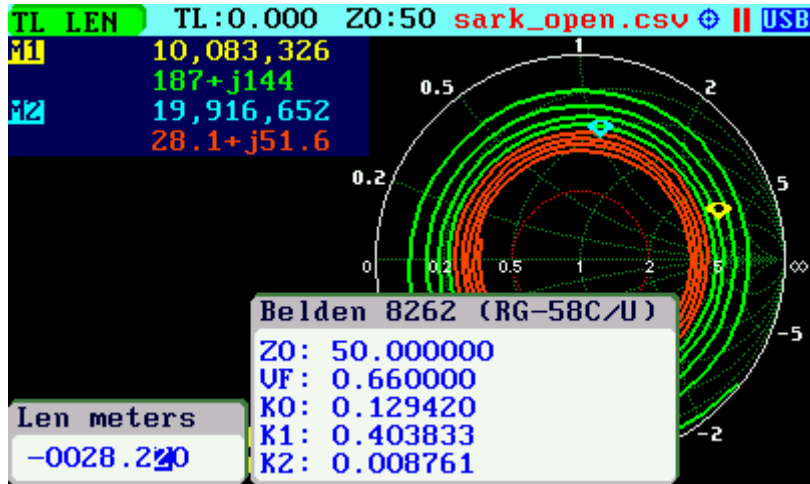

4.2 Circuit Models

The SARK-110 provides advanced analysis features, including the automatic determination of the circuit models of small loop antennas or coils, capacitors and quartz crystals. It is also capable of automatically determining different parameters having to do with transmission lines.

It is essential that the analyzer is calibrated before each measurement for accurate results when using these functions. The open, short and load calibration loads have to be connected to the end of the test port extension cable being employed. Please refer to Appendix D on how to carry out the steps for OSL calibration.

The measurement results can be saved in a file in tabular format or as a screenshot.

The Circuit Models function is only available in the Single Frequency Mode. Select «**MODE**» «*Single Frequency*» to change to the Single Frequency mode. Then select «**CMODEL**» in the main menu and the desired function in the pop-up submenu.

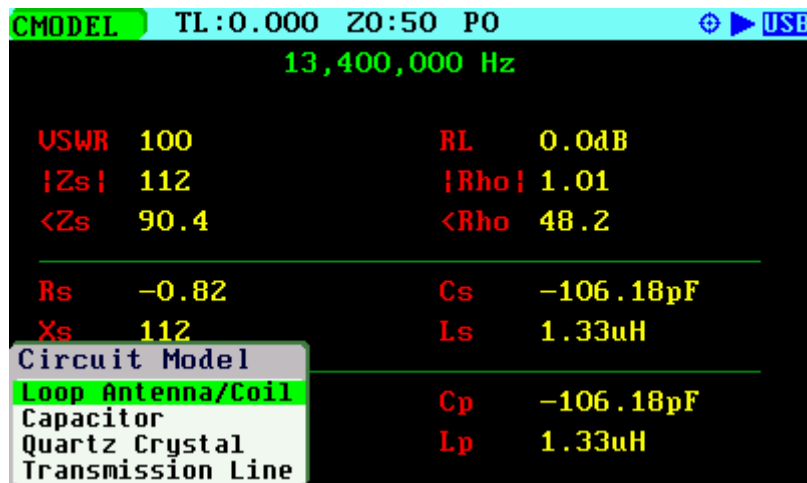

4.2.1 Loop Antenna/Coil

This function determines the equivalent circuit model of small loop antennas or coils. This function is specially tailored for the measurement of antennas for HF RFID applications. Detailed usage of this function is described in the Application Note available at: <http://www.sark110.com/application-notes/rfid-appnote>

The measurement procedure is as follows:

Select the file name and press [●] or select [▲] when the results are not to be saved in a file

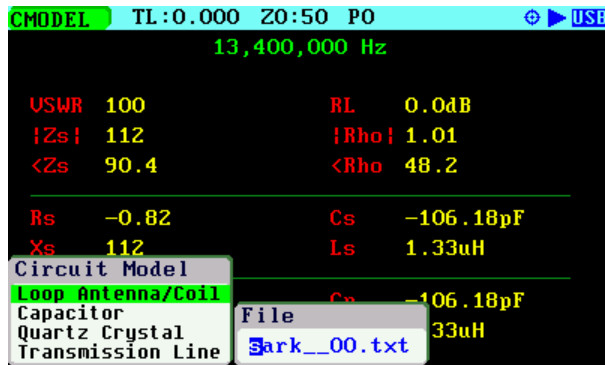

Enter the desired operating frequency

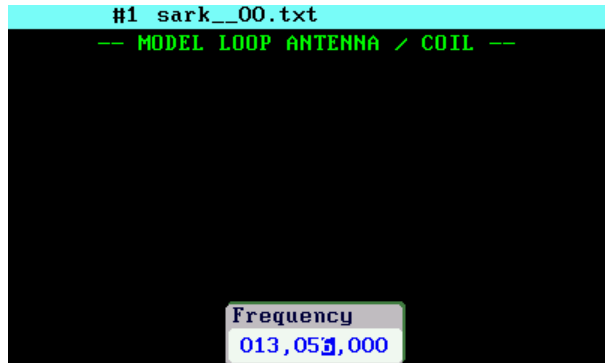

Enter the desired scan limit

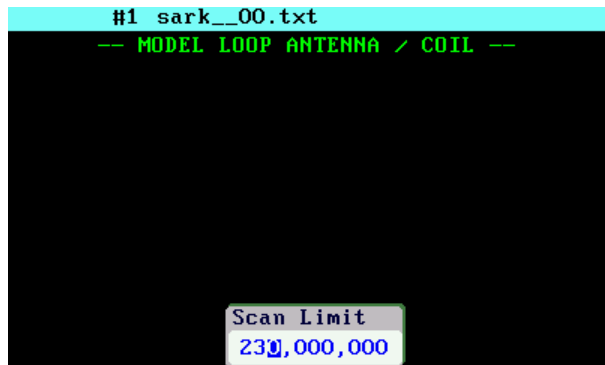

After some seconds the results are shown on the screen.

A screenshot can be captured by selecting [●]

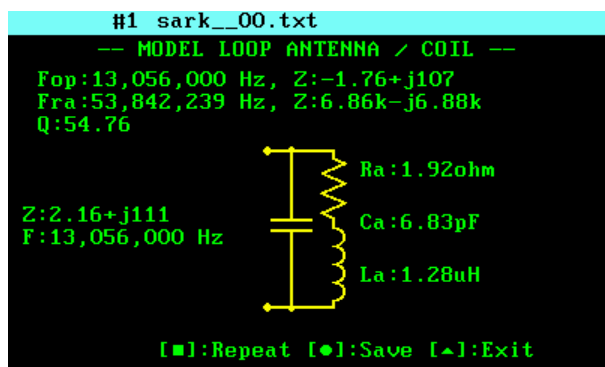

The figure below describes the measured parameters:

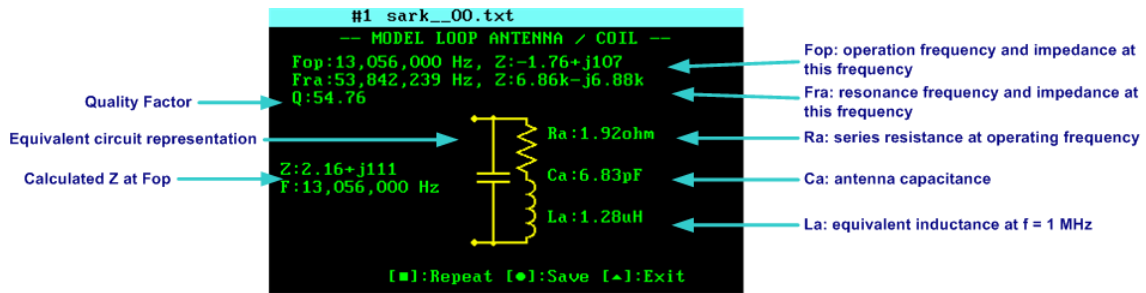

The internal procedure performed by the analyzer is as follows: the analyzer measures the impedance at 1 MHz and at the desired operating frequency (e.g. 13.56 MHz). Then it searches for the antenna's self-resonant frequency and measures the impedance at that point. The following parameters are extracted from these measurements:

- Fra Self-resonant frequency of the antenna
- Z(Fop) Z at operating frequency
- Z(Fra) Z at resonant frequency
- Rs Equivalent resistance at F = 1 MHz
- La Equivalent inductance at F = 1 MHz
- Rp Equivalent resistance at the self-resonant frequency

The antenna capacitance is calculated with the following equation:

$$Ca = \frac{1}{La \times (2 \times \pi \times Fra)^2}$$

The series equivalent resistance of the antenna at the operating frequency $Fop = 13.56$ MHz is calculated with the following equation:

$$Ra = Rs + \frac{(2 \times \pi \times Fop \times La)^2}{Rp}$$

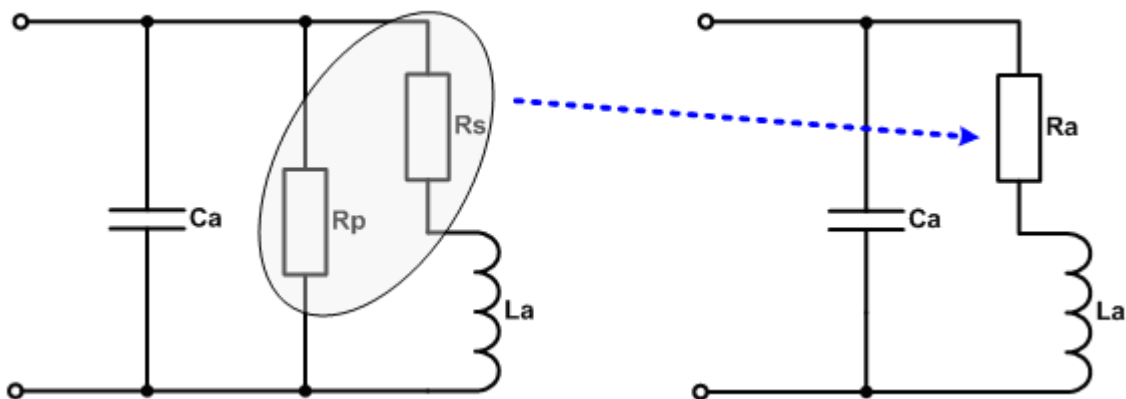

The quality factor is calculated using the following equation:

$$Qa = \frac{2 \times \pi \times Fop \times La}{Ra}$$

4.2.2 Capacitor

This function determines the equivalent circuit model of capacitors. The measurement procedure is as follows:

Select the file name and press [●] or select [▲] when the results are not to be saved in a file

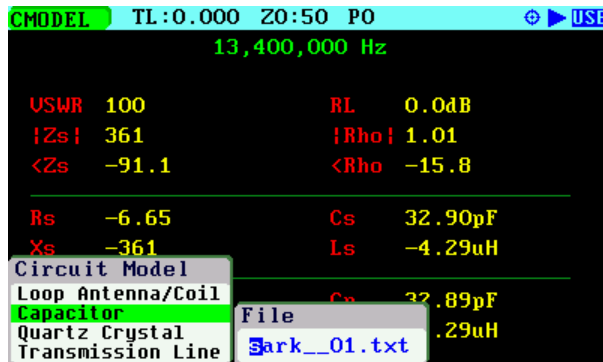

Enter the operating frequency



After some seconds the results are shown on the screen.

A screenshot can be captured by selecting [●]

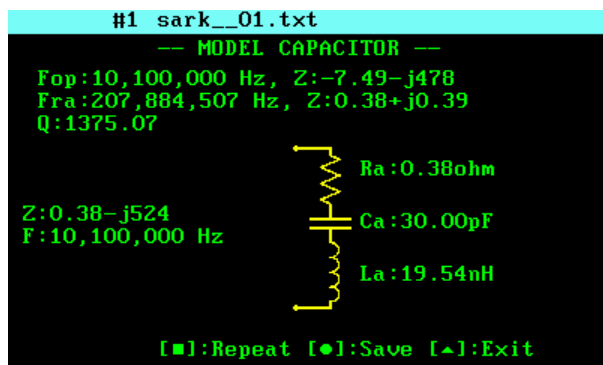

The figure below describes the measured parameters:

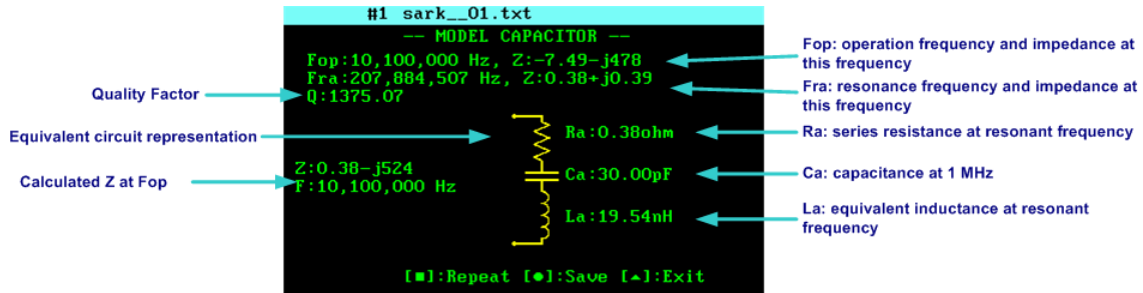

The internal procedure performed by the analyzer is as follows: the analyzer measures the impedance at 1 MHz and at the desired operating frequency. Then it searches for the self-resonant frequency and measures the impedance at this point. The following parameters are extracted from these measurements:

- Fra Self-resonant frequency of the capacitor
- Z(Fop) Z at operating frequency
- Z(Fra) Z at resonance frequency
- Ca Equivalent capacitance at F = 1 MHz
- Ra Equivalent resistance at the self-resonant frequency

The capacitor's parasitic inductance is calculated with the following equation:

$$La = \frac{1}{Ca \times (2 \times \pi \times Fra)^2}$$

The quality factor is calculated using the following equation:

$$Qa = \frac{1}{(2 \times \pi \times Fop \times Ca \times Ra)}$$

4.2.3 Quartz Crystal

This function determines the equivalent circuit model of quartz crystals. Detailed usage of this function is described in the Application Note available at: <http://www.sark110.com/application-notes/equivalent-circuit-determination-of-quartz-crystals>

The measurement procedure is as follows:

Select the file name and press [●] or select [▲] when the results are not to be saved in a file

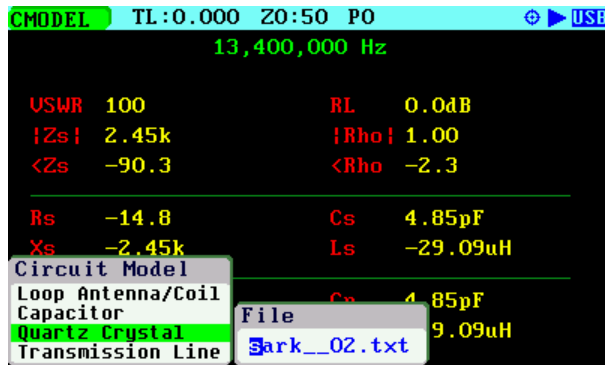

Enter the frequency value, which should be close to the expected resonant frequency of the crystal



Enter the estimated crystal bandwidth value

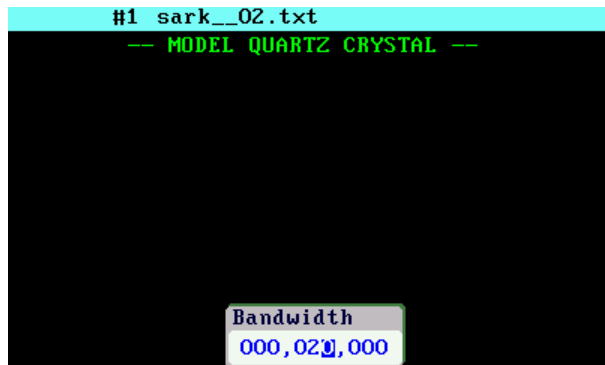

After some seconds the results are shown on the screen.

A screenshot can be captured by selecting [●]

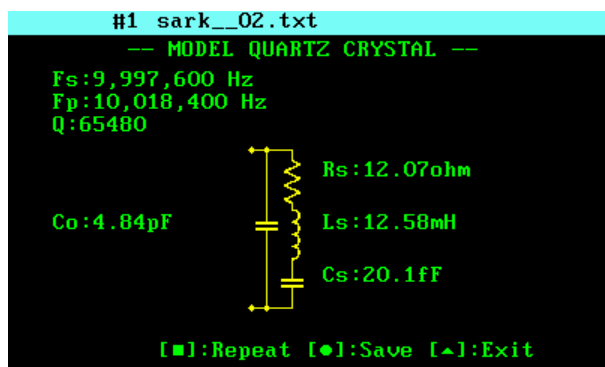

The figure below describes the measured parameters:

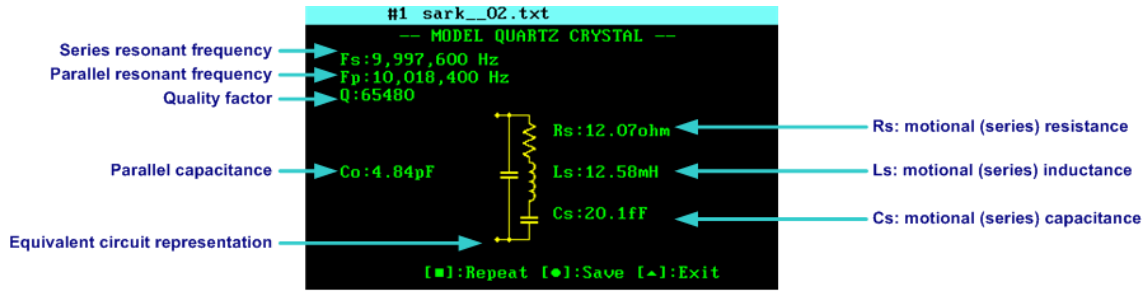

The process starts by searching for the series and parallel resonant frequencies. The start scan frequency is taken from the specified frequency value.

The resonant frequencies are identified in the singularities where the impedance changes from pure capacitive (phase value close to -90°) to pure inductive (phase value close to $+90^\circ$). The resonant frequencies are then obtained from the frequency points where the measured phase value is close to zero.

After determining the series and parallel resonant frequencies, the series resistance (R_s) at the series resonant frequency is measured. Then the parallel capacitance (C_o) is measured. This value is measured from a frequency that is 2.5 MHz below F_s and 2.5 MHz above F_p . From these measurements, the rest of the parameters are derived:

The value of series capacitance (C_s) is given by:

$$C_s = 2 \times C_o \times \left(\frac{F_p}{F_s} - 1 \right)$$

The value of the series inductance (L_s) is given by:

$$L_s = \frac{1}{(4 \times \pi^2 \times F_s^2 \times C_s)}$$

Finally, the quality factor of the crystal (Q) is calculated by:

$$Q = \frac{1}{R_s} \times \sqrt{\frac{L_s}{C_s}}$$

4.2.4 Transmission Line

This feature allows you to automatically measure different parameters having to do with transmission lines, namely:

- The line's characteristic impedance (Z_0)
- The true velocity factor
- The matched line loss in terms of dB over the total line length and in dB/100m

The measurement procedure is as follows:

Select the file name and press [•] or select [▲] when the results are not to be saved in a file

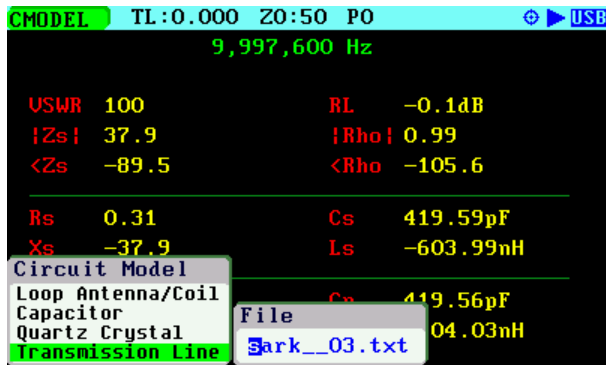

Enter the start frequency

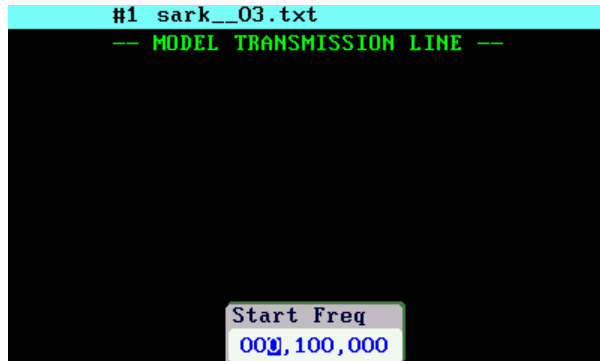

Enter the stop frequency

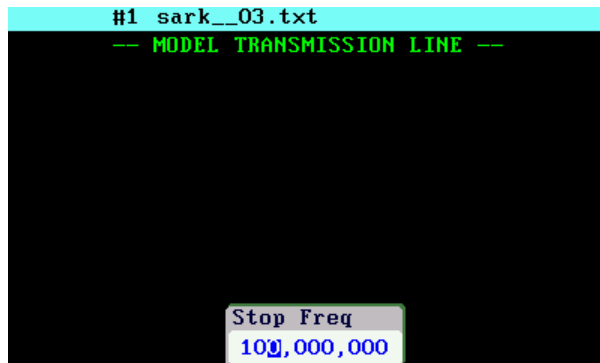

Enter the transmission line length

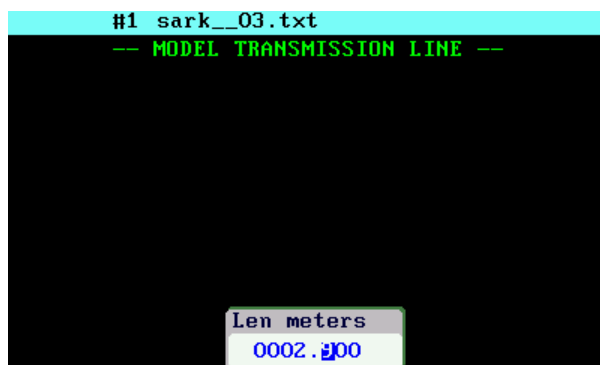

Connect the transmission line terminated with an open circuit.
Press the appropriate button to continue, or to exit.

```
#1 sark__03.txt
-- MODEL TRANSMISSION LINE --
Start: 100,000
Stop: 100,000,000
Points: 258
Len meters: 2.90
1: Connect open terminated line
[ ]:Continue [^]:Exit
```

Connect the transmission line terminated with a short circuit.
Press the appropriate button to continue, or to exit.

```
#1 sark__03.txt
-- MODEL TRANSMISSION LINE --
Start: 100,000
Stop: 100,000,000
Points: 258
Len meters: 2.90
2: Connect short terminated line
[ ]:Continue [^]:Exit
```

After some seconds the results are shown on the screen.
A screenshot can be captured by selecting [•]

```
#1 sark__03.txt
-- MODEL TRANSMISSION LINE --
Start: 100,000
Stop: 100,000,000
Points: 258
Len meters: 2.90
Z0: 52.58
VF: 0.64 @ 100.00M
Matched Loss:
0.91 dB, 31.42 dB/100m @ 100.00M
0.37 dB, 12.67 dB/100m Average
[ ]:Repeat [•]:Save [^]:Exit
```

Note: Try to keep the electrical length of the line exactly the same between the open and short termination conditions. Ideally you would terminate the line with the same standard loads that were used to do the Open Short Load (OSL) calibration.

Z0 is obtained by calculating the arithmetic mean of the real part of the following equation for all the frequency points:

$$Z0 = \sqrt{Zoc \times Zsc}$$

The calculation of the Velocity Factor (VF) and matched loss is more convoluted and will not be explained here. The relevant information is that the VF is provided at the upper frequency and the matched loss is provided at the maximum frequency and the arithmetic mean for all frequency points.

4.3 Tuning Stubs

The SARK-110 facilitates making $\frac{1}{4}\lambda$, $\frac{1}{2}\lambda$ and other coaxial stubs with the help of Markers Info feature. Markers Info dialog box provides information about the electrical length of the line.

Let's illustrate the tuning procedure with an example. In this case we are going to make a $\frac{1}{4}\lambda$ stub with a RG-58 cable for a frequency of 20 MHz.

Select «**SETUP**» «Stubs» and specify the fraction of wavelengths (wavelength=0.25) and the cable velocity factor (VF=0.66).

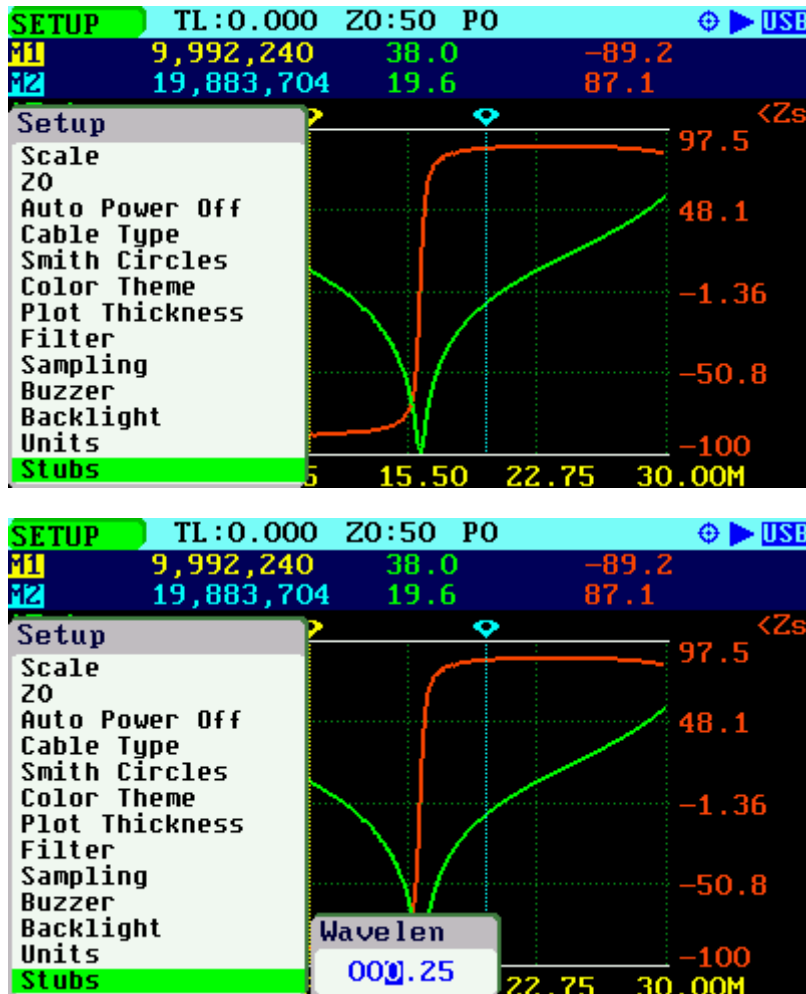

From the Scalar Chart mode, select start frequency of 1 MHz and stop frequency above the desired frequency –in this case it is set to 30 MHz.

Move Marker 2 to the frequency closed to the desired frequency (20 MHz) and select «**MARK 2**» «Info». At the bottom of the dialog box, “Len” indicates the calculated electrical length of the coax cable.

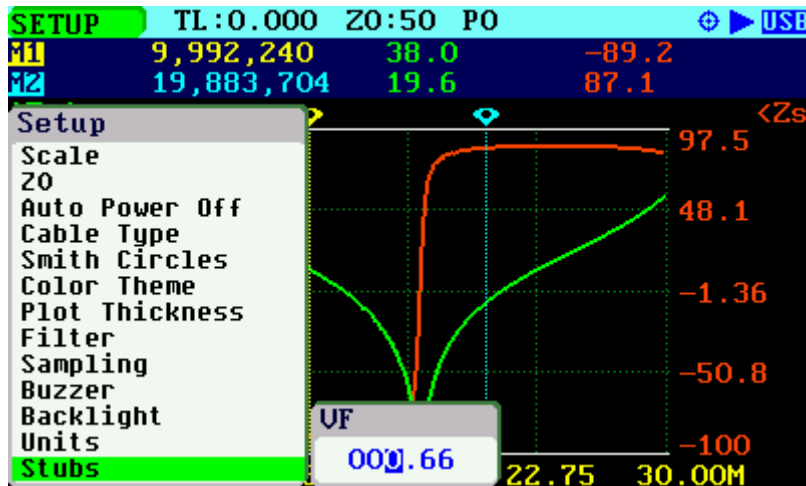

Cut a piece slightly longer than this value and connect to the analyzer. Move the Marker 1 to the point where $\angle Z_s$ (or X_s) crosses zero. In this case this frequency point is at 16.286 MHz.

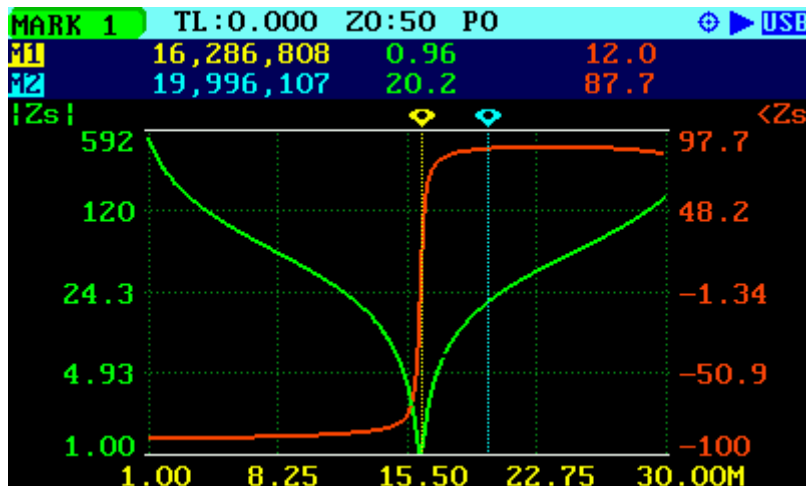

Select «MARK 1» «Info». The readings show a length of 3.037m and a length difference (M1-M2) of 0.563m, which is the excess length of the piece of coax cable. Cut a piece slightly shorter than this value and repeat the process until getting to the expected value.



Appendix A: Theory of Operation

The block diagram below illustrates the main functional blocks of the SARK-110 Antenna Analyzer:

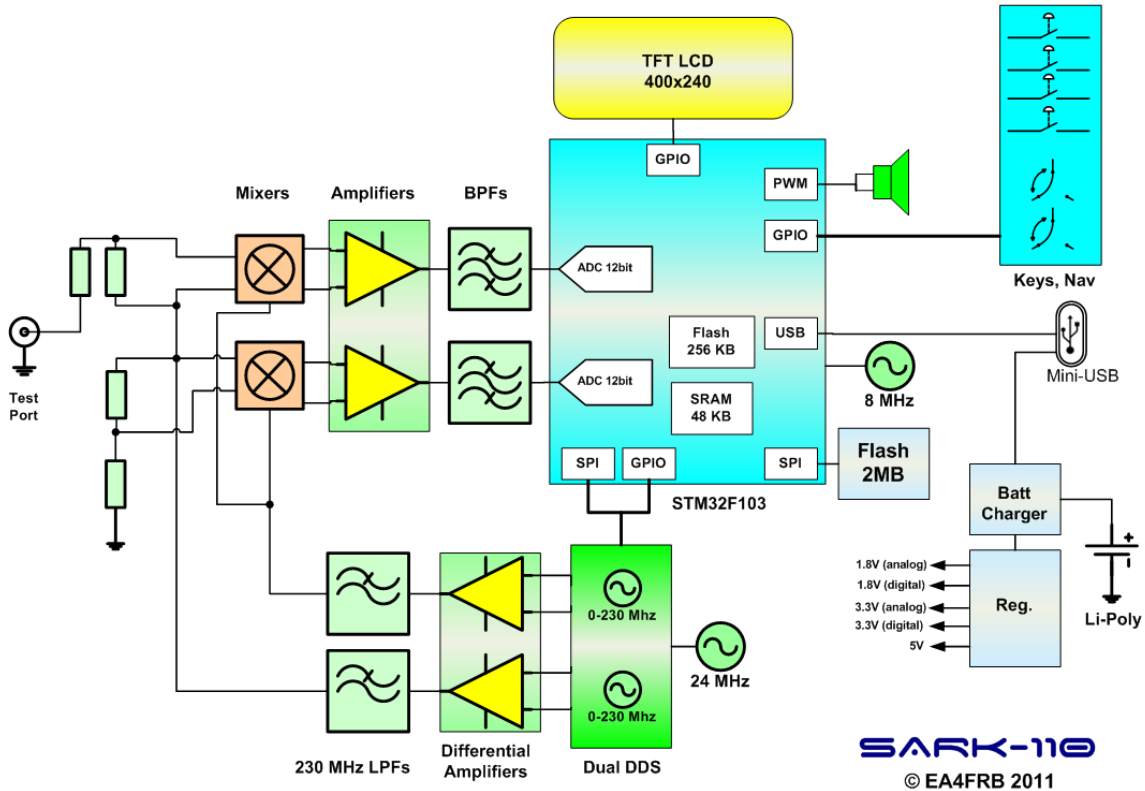

The SARK-110 comprises four main sections: a signal generator used as an active source, a bridge to provide signal separation, two tuned receivers that downconvert and detect the signals and a microcontroller and display for calculating and reviewing the results.

The signal generator is provided by a single chip dual direct digital synthesizer (DDS) AD9958 from Analog Devices, which generates a sinusoidal signal for impedance measurement and a local oscillator signal for the tuned receivers (mixers). One of the DDS channels operates at the specified test frequency and the other is programmed to operate just 1 kHz above it, which is the value of the intermediate frequency. The DDS has an internal oscillator driven by an external 24 MHz crystal and is able to multiply this clock internally by a user configurable factor of 4 to 20, so the maximum internal clock frequency is 480 MHz. In general the DDS can be configured to generate a frequency of up to one third of the clock frequency but in this design, due to the external reconstruction filter, it is possible to achieve an output frequency of up to 230 MHz.

The amplitude level of the DDS channel's output is frequency dependent and it is reduced with increasing frequency following a $\text{SIN}(X)/X$ function. The SARK-110 software compensates for this amplitude rolloff effect by using the capability of the DDS to adjust the amplitude level of the output signal, so the analyzer maintains a flat output amplitude.

The output of each of the DDS channels is differential and is amplified by a dual high speed current feedback amplifier working in differential input mode and with output in single ended

mode. Most DDS designs use a broadband balun transformer to convert to single end mode but because of the restricted height available in the SARK110 enclosure a silicon-based solution was chosen.

The output of each amplifier is followed by elliptic low pass filters with a cut-off frequency of 230 MHz. These filters reduce the level of spurious high frequency components that appear in the output of the DDS. These high frequency components consist of aliases at multiples of the internal clock frequency as well as other spurs.

For impedance measurement a resistive bridge is used because of its simplicity and good frequency response, working down to DC. In the bridge the voltage across one resistor is proportional to the voltage being applied to the circuit under test and the voltage across another resistor is proportional to the current flowing into the circuit connected to the analyzer's test port. Both the magnitude and phase are measured. The ratio of the two corresponds to the impedance we want to measure.

One of the mixers is used for the voltage measurement and the other for the current measurement. The output of the mixers is the 1 kHz I.F. signal which is then amplified and filtered with a bandpass filter before digitizing. Identical mixer and amplifier circuits are used for both the voltage and current sensing paths. Any small differences in the gain and phase shift of these two signal paths are taken care of by the calibration process.

The core of the analyzer is an STM32F103 microcontroller from STMicroelectronics. This microcontroller incorporates the high-performance ARM Cortex M3 32 bit core operating at 72 MHz, a Flash memory of 256 kB, SRAM of 48 kB and an extensive range of I/O and peripherals including a USB device controller and three 12-bit ADC converters. The digitizing of the 1 kHz I.F. signal is done by two independent 12-bit ADC converters contained in the STM32 MCU. These two converters operate simultaneously and are synchronized, so providing good accuracy for the phase measurement.

The two sets of digital data from the voltage and current sensors are analyzed using an optimized implementation of the discrete Fourier transform that works with a single bin. This produces the amplitude and phase of the 1 kHz fundamental signal and cancels out any DC component due to offsets in the operational amplifiers. The load impedance magnitude is the voltage amplitude divided by the current amplitude. The phase angle of the impedance is the difference in the phase angles of the voltage and current. Knowing these two parameters, we can calculate the equivalent resistance and reactance of the load impedance. The rest of the parameters such as VSWR, reflection coefficient, etc. are derived from the measured impedance value.

Appendix B: Fundamental Parameters

Abbreviation	Parameter	Description
Rs	Series resistance	Resistive value of a series impedance
Xs	Series reactance	Reactance value of a series impedance
Rp	Parallel resistance	Resistive value of a parallel impedance
Xp	Parallel reactance	Reactance value of a parallel impedance
Zs	Magnitude of a series Impedance	Represents the absolute magnitude of the ratio of the voltage difference amplitude to the current amplitude. $ Z = \sqrt{R^2 + X^2}$
<Zs	Impedance Angle	It is a measure of the phase angle of the ratio of the amplitude of the voltage to the amplitude of the current, expressed in degrees.
VSWR	Voltage Standing Wave Ratio	It is a measure of how efficiently radio-frequency power is transmitted from a power source, through a transmission line and into a load (for example, from a power amplifier through a transmission line and into an antenna).
RL	Return Losses (S11 dB)	Return loss is the negative of the magnitude of the reflection coefficient in dB. $RL = 20 \times \log_{10}(Rho)$
CL	Cable Losses	Measurement of insertion loss of a cable in dB. The measurement should be performed by applying a short circuit at the cable end. $CL = ABS\left(\frac{RL}{2}\right)$
Rho	Magnitude of a Reflection Coefficient (Rho or S11)	It is a measure of the absolute magnitude of the ratio of the amplitude of the reflected wave to the amplitude of the incident wave.

Abbreviation	Parameter	Description
<Rho	Reflection Coefficient Angle (S11 Angle)	<p>It is a measure of the phase angle of the ratio of the amplitude of the reflected wave to the amplitude of the incident wave.</p> $Ph = a \tan\left(\frac{RhoI}{RhoR}\right)$
%Ref Pwr	Percentage of Reflected Power	$\%RPwr = Rho^2 \times 100$
Q	Quality Factor	<p>It is defined as the ratio of the energy stored in a component to the energy dissipated by the component.</p> $Q = \frac{X}{R}$
Cs	Series Capacitance	Equivalent series capacitance at the measurement frequency in picofarads
Ls	Series Inductance	Equivalent series inductance at the measurement frequency in microhenries
Cp	Parallel Capacitance	Equivalent parallel capacitance at the measurement frequency in picofarads
Lp	Parallel Inductance	Equivalent parallel inductance at the measurement frequency in microhenries

Appendix C: Upgrading the firmware

The SARK-110's firmware may be upgraded via USB as described in the following steps. This procedure assumes you have downloaded the appropriate update file from: <http://www.sark110.com/files/firmware>

The downloaded file has the following format:

SARK110-APP-x.y.z.dfu.zip Where x.y.z is the incremental version number.

The downloaded file has to be unzipped to produce an update file in the format:

SARK110-APP-x.y.z.dfu

Procedure:

1. Connect the SARK-110 to the PC with a USB cable
2. Locate the SARK's USB flash drive unit using the File Explorer of your PC
3. Copy the firmware file, e.g. SARK110-APP.x.y.z.dfu to the SARK's USB flash drive unit
4. Do a safe eject of the SARK's USB flash drive unit from your computer
5. Power off the SARK-110 and power it on again while simultaneously holding down the Run/Hold [▶||] button
6. The Device Firmware Upgrade screen prompts you to install the firmware file
7. If several firmware files are on the SARK's USB flash drive unit, use Navigator B to select the file to load
8. The firmware upgrade will commence after pressing the Select [■] button
9. Once complete, press the "Save Conf" [▲] button, which will reset the analyzer and run the upgraded firmware
10. Select «**SETUP**» «*About*» and check if the firmware version shown on the screen agrees with the installed one

Appendix D: OSL Calibration

The SARK-110 provides a calibration procedure to compensate for the stray capacitance and impedance of the external test fixture, e.g. the extension cable. This should be performed every time the external test fixture is changed as well as periodically.

Calibration is performed by using a set of calibration plugs consisting of: an Open circuit, a Short circuit and a calibrated Load having the same value as the reference impedance. These loads are connected sequentially to the end of the test lead as instructed on the screen as described below.

- To set the reference impedance, please refer to **Setup - Z0** in the chapter 2.14.

The place where these loads are connected during the calibration is called the Reference Plane.

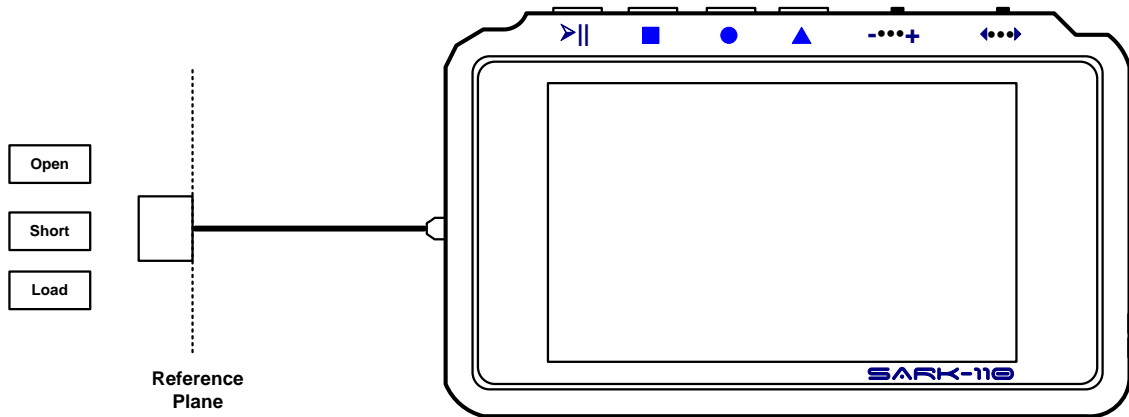

The analyzer performs a series of measurements with these loads, calculating error coefficients that are stored in a file that is automatically loaded each time the analyzer is run. These error coefficients are used to correct the measured values. The number of calibration points is fixed to 400.

The frequency range for the calibration can be programmed by the user, allowing setting a narrower frequency span for higher resolution measurements.

The device supports the storage of up to eight calibration profiles. These profiles can be associated to different test port adapters or different frequency ranges.

Select «**SETUP**» «*Calibration*» «OSL Profile» to set the active calibration profile. The active profile is shown in the status line; e.g. "P0" for profile 0.

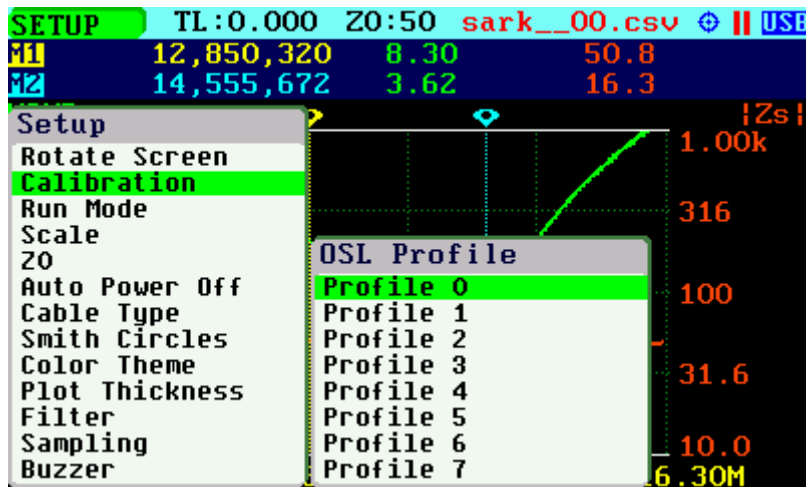
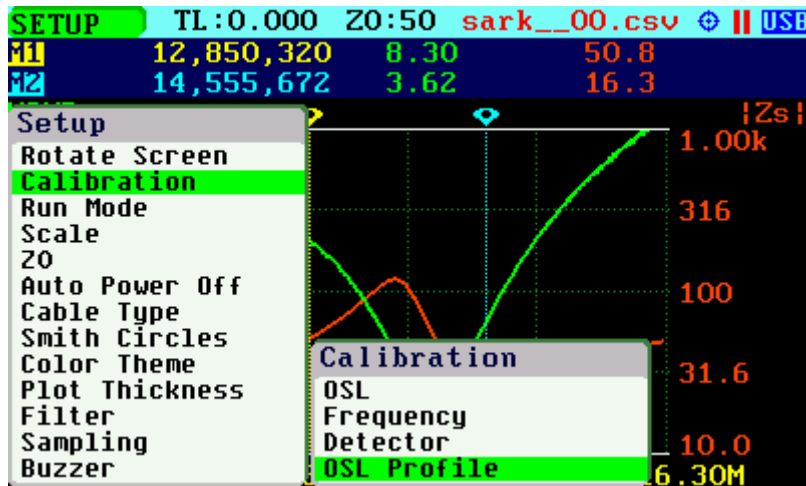

After selecting the calibration profile, the profile characteristics are shown in a popup dialog.

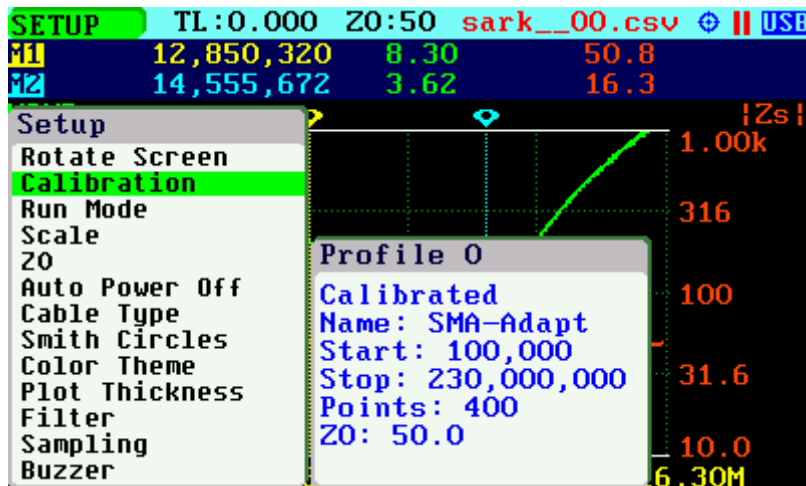

Once the calibration profile has been selected, choose **«SETUP» «Calibration» «OSL»** to start the OSL calibration procedure.

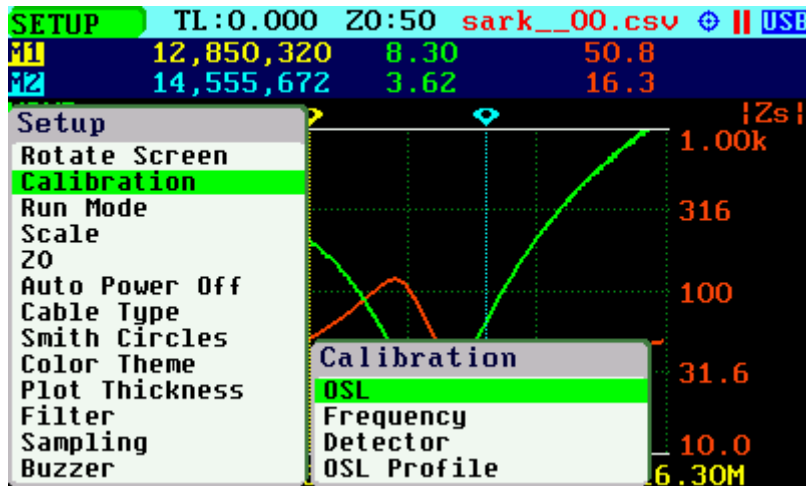

The calibration procedure is as follows:

Enter the start frequency (default is the lower frequency limit)



Enter the stop frequency (default is the upper frequency limit)



Enter an optional name for the profile

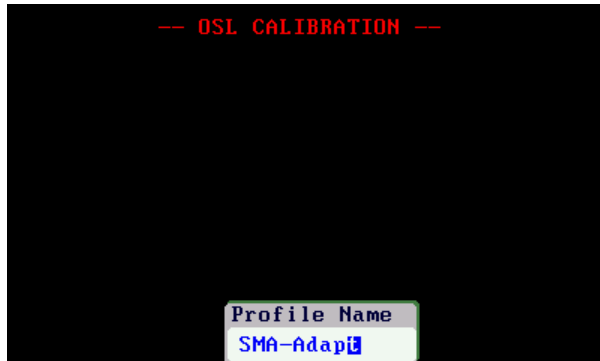

Connect the open load.

Load status is indicated by the color of the |Rh| indicator. Green denotes load good status.

Press the appropriate button to continue, or to exit.

```
--- OSL CALIBRATION ---
Profile: 0
Name: SMA-Adapt
Start: 100,000
Stop: 230,000,000
Points: 400
ZO: 50.0

1: Connect open load

|Rh|:1.00<-0.0

[■]:Continue [▲]:Exit
```

The calibration progress will be shown in the display bar.

```
--- OSL CALIBRATION ---
Profile: 0
Name: SMA-Adapt
Start: 100,000
Stop: 230,000,000
Points: 400
ZO: 50.0

Open Standard
██████████
Progress 36%

[▲]:Exit
```

Connect the short-circuit load.

Load status is indicated by the color of the |Rh| indicator. Green denotes load good status.

Press the appropriate button to continue, or to exit.

```
--- OSL CALIBRATION ---
Profile: 0
Name: SMA-Adapt
Start: 100,000
Stop: 230,000,000
Points: 400
ZO: 50.0

2: Connect short load

|Rh|:1.01<-179.9

[■]:Continue [▲]:Exit
```

The calibration progress will be shown in the display bar.

```
--- OSL CALIBRATION ---
Profile: 0
Name: SMA-Adapt
Start: 100,000
Stop: 230,000,000
Points: 400
ZO: 50.0

Short Standard
██████████
Progress 28%

[▲]:Exit
```

Connect the reference load.

Load status is indicated by the color of the |Rh| indicator. Green denotes load good status.

Press the appropriate button to continue, or to exit.

```

-- OSL CALIBRATION --
Profile: 0
Name: SMA-Adapt
Start: 100,000
Stop: 230,000,000
Points: 400
ZO: 50.0

3: Connect 50-ohm load

|Rh|:0.02<-153.0

[■]:Continue [▲]:Exit
    
```

The calibration progress will be shown in the display bar.

```

-- OSL CALIBRATION --
Profile: 0
Name: SMA-Adapt
Start: 100,000
Stop: 230,000,000
Points: 400
ZO: 50.0

Termination Standard
██████████
Progress 34%

[▲]:Exit
    
```

Press the appropriate button to apply the new calibration settings, or to cancel them.

```

-- OSL CALIBRATION --
Profile: 0
Name: SMA-Adapt
Start: 100,000
Stop: 230,000,000
Points: 400
ZO: 50.0

Completed

[■]:Apply [▲]:Cancel
    
```

Appendix E: Frequency Calibration

This setup permits the frequency synthesizer to be calibrated to 1 Hz. The calibration operation is available at «**SETUP**» «*Calibration*» «Frequency».

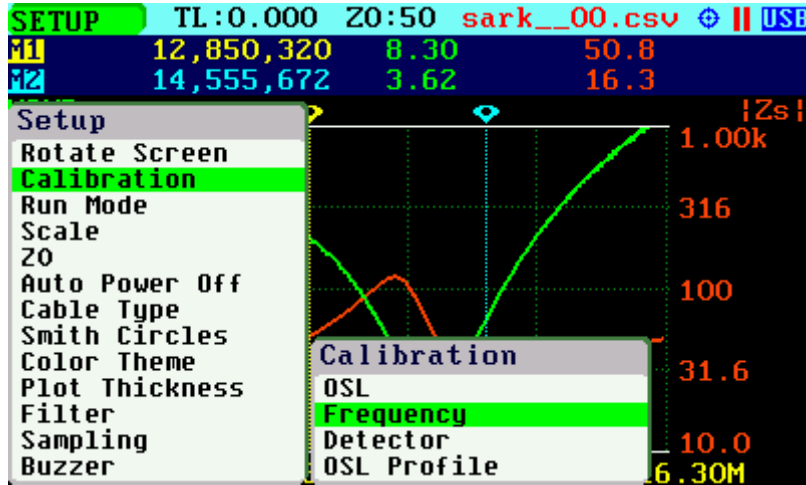

To calibrate the synthesizer, select «Frequency» from the «*Calibration*» submenu and adjust the frequency while measuring it with an accurate frequency counter or, alternatively, zero-beat it against WWV. Use Navigator B to change the frequency. The frequency will change according to the current frequency multiplier that is highlighted in reverse video. Use Navigator A to change the frequency multiplier position if needed. When an exact 10 MHz output is obtained, press the Select [■] button to permanently store the setting.

- For best accuracy, turn on the unit for at least 10 or 15 minutes before calibrating.

Press the Save Screen [●] button if the default setting needs to be restored.

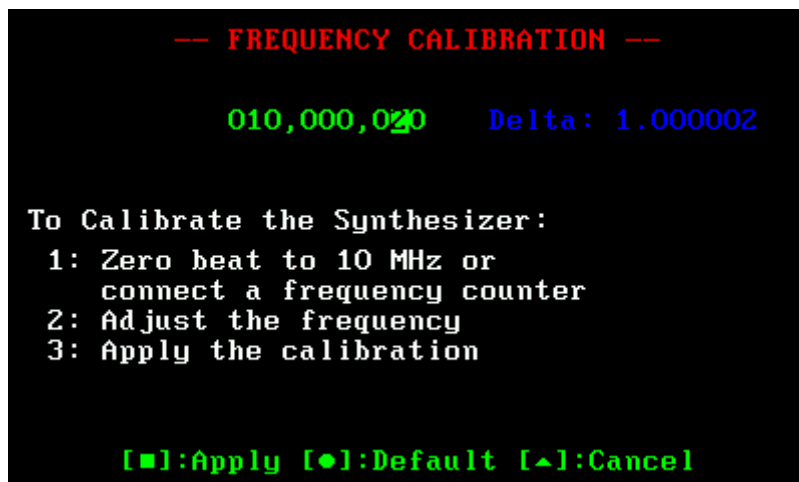

Appendix F: Detector Calibration

This procedure performs alignment of the SARK-110's internal measurement circuits. This operation is done once at the factory and it is not necessary for the user to repeat it, but the procedure is detailed for completeness. This procedure comprises a calibration phase and an optional detector-test phase to check the detector circuits.

For Detector calibration, the Short load is connected directly at the Test port; see the figure below. For the optional detector test phase, the following loads are required: 50, 100 and 200-ohm.



Before performing this operation it is strongly recommended that the file containing the factory results, **detcalib.dat**, is backed up to enable a restore, if needed.

Select «**SETUP**» «*Calibration*» «Detector» to start the detector calibration procedure.

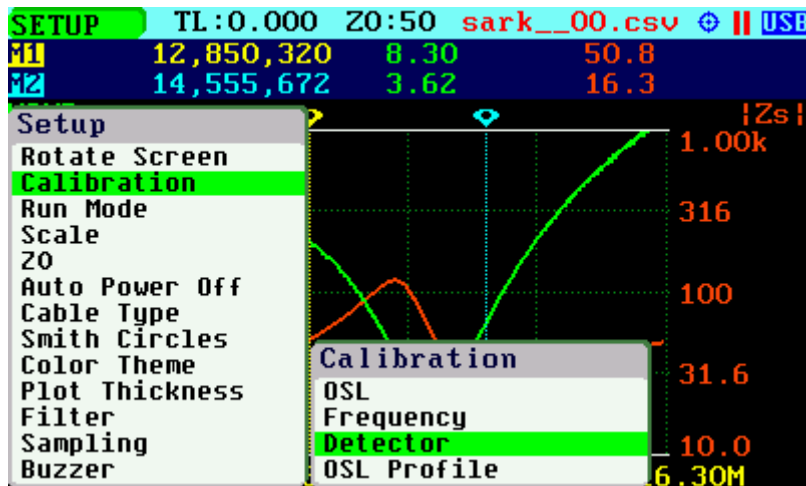

The calibration procedure is as follows:

Connect the short load.

Load status is indicated by the color of the voltage and current detector indicators. Green denotes a load good status.

Press the appropriate button to continue, or to exit.

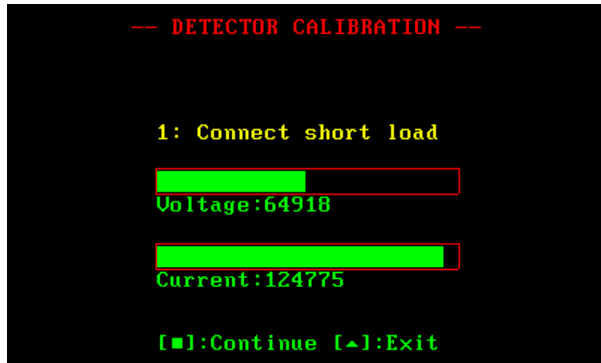

The calibration progress will be shown in the display bar.



The calibration is completed.

The calibration coefficients are shown at the bottom of the screen, for information.

Press the appropriate button to apply the new calibration settings, or to cancel them.

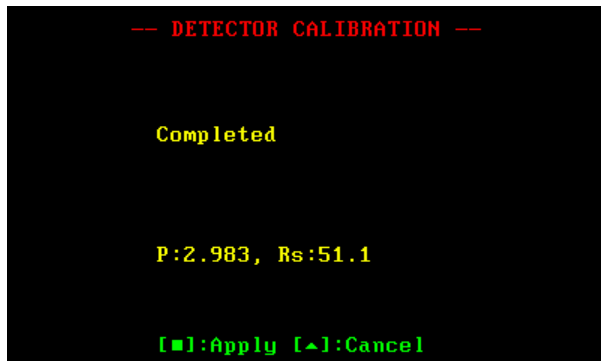

Press the appropriate button to go to the optional Detector Test, or to exit.

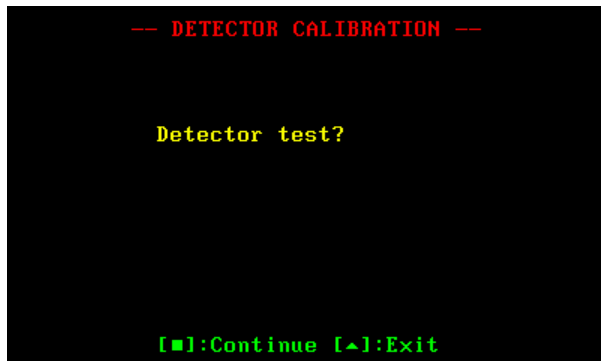

Connect the 0-ohm load.

Load status is indicated by the color of the voltage and current detector indicators. Green denotes a load good status.

Press the appropriate button to continue, or to exit.



Connect the 50-ohm load.

Load status is indicated by the color of the voltage and current detector indicators. Green denotes a load good status.

Press the appropriate button to continue, or to exit.

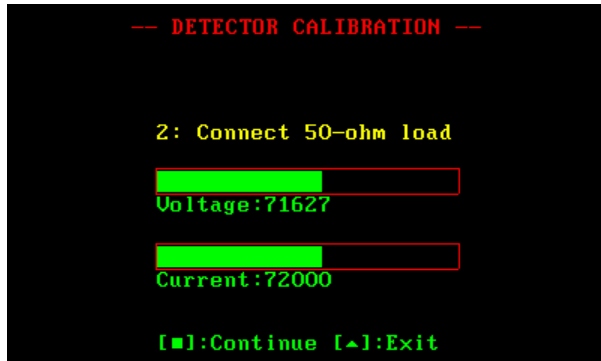

Connect the 100-ohm load.

Load status is indicated by the color of the voltage and current detector indicators. Green denotes a load good status.

Press the appropriate button to continue, or to exit.

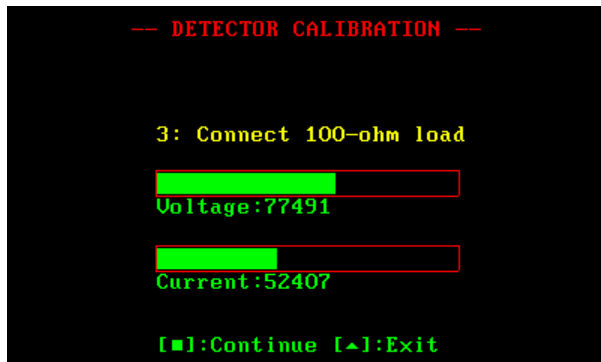

Connect the 200-ohm load.

Load status is indicated by the color of the voltage and current detector indicators. Green denotes a load good status.

Press the appropriate button to continue, or to exit.

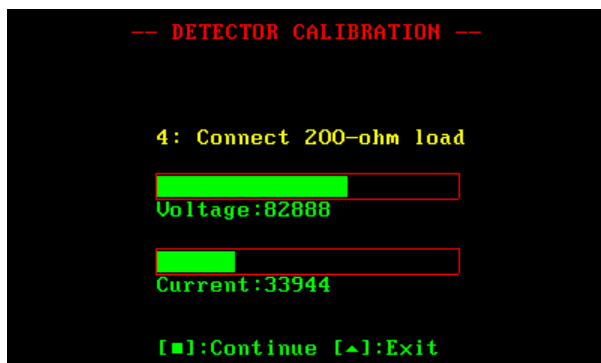

Press the appropriate button to repeat the test, or to exit.

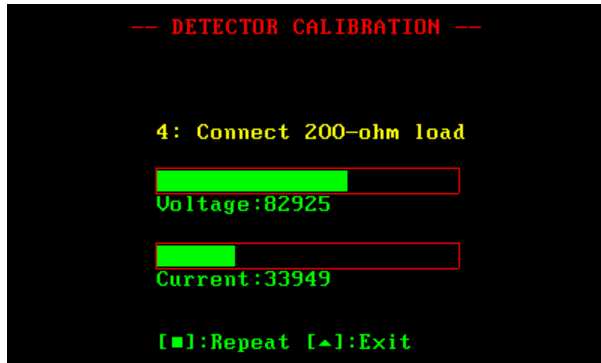

Appendix G: Frequency Presets File

Default frequency presets can be modified by the user by supplying a special text file stored on the analyzer's disk. The file name must be "presets.txt" and the format for each band entry in the file is as follows:

legend, start_freq, stop_freq, def_mul_freq, def_mul_span, marker1_freq, marker2_freq

Where:

- legend: string to be displayed in the preset menu (max length: 20)
- start_freq: start frequency, specified in MHz
- stop_freq: stop frequency, specified in MHz
- def_mul_freq: default multiplier for setting the frequency
- def_mul_span: default multiplier for setting the span
- marker1_freq: default marker 1 frequency, specified in MHz
- marker2_freq: default marker 2 frequency, specified in MHz

Example:

```
600M: 500 KHz,      0.1,   0.9,   3, 4, 0.2,   0.5
160M: 1.8 MHz,     1.3,   2.3,   4, 5, 1.8,   2.0
80M: 3.6 MHz,      1.6,   5.6,   5, 6, 3.5,   3.8
60M: 5.3 MHz,      3.3,   7.3,   5, 6, 5.2,   5.5
40M: 7.1 MHz,      5.1,   9.1,   5, 6, 7.0,   7.2
30M: 10.1 MHz,     8.1,  12.1,   5, 6, 10.1,  10.2
HF RFID: 13.5 MHz, 11.5,  15.5,   5, 6, 13.0,  14.0
20M: 14.2 MHz,     12.2,  16.2,   5, 6, 14.0,  14.4
17M: 18.1 MHz,     16.1,  20.1,   5, 6, 18.0,  18.2
15M: 21.2 MHz,     19.2,  23.2,   5, 6, 21.0,  21.5
12M: 24.9 MHz,     22.9,  26.9,   5, 6, 24.8,  25.0
11M: 27.8 MHz,     25.8,  29.8,   5, 6, 27.0,  28.0
10M: 29 MHz,       26.0,  32.0,   6, 7, 28.0,  29.7
6M: 51 MHz,        48.0,  54.0,   6, 7, 50.0,  52.0
4M: 70.1 MHz,      68.1,  72.1,   5, 6, 70.1,  70.2
2M: 145 MHz,       142.0, 148.0,  6, 7, 144.0, 146.0
Full HF,           0.1,   32.0,   6, 6, 10.0,  20.0
Full Span,         0.1,  230.0,  7, 7, 75.0,  150.0
```

Appendix H: Scale Presets

The following tables show the default scale presets:

Normal	Min	Max	Scale
Rs	10	1000	Log
Xs	-500	500	Linear
Rp	10	1000	Log
Xp	-500	500	Linear
Zs	10	1000	Log
<Zs	-100	100	Linear
VSWR	1.00	25.00	Log
RL	-40	0	Log
CL	0	20	Log
Rho	0	1.0	Linear
<Rho	-190	190	Linear
%Rp	0	100	Linear
Q	0	20	Linear
Cs	-10000	10000	Linear
Ls	-100	100	Linear
Cp	-10000	10000	Linear
Lp	-100	100	Linear

High	Min	Max	Scale
Rs	10	5000	Log
Xs	-2500	2500	Linear
Rp	10	5000	Log
Xp	-2500	2500	Linear
Zs	10	5000	Log
<Zs	-100	100	Linear
VSWR	1.00	100.00	Log
RL	-60	0	Log
CL	0	30	Log
Rho	0	1.0	Linear
<Rho	-190	190	Linear
%Rp	0	100	Linear
Q	0	50	Linear
Cs	-100000	100000	Linear
Ls	-1000	1000	Linear
Cp	-100000	100000	Linear
Lp	-1000	1000	Linear

Low	Min	Max	Scale
Rs	0	250	Linear
Xs	-125	125	Linear
Rp	0	250	Linear
Xp	-125	125	Linear
Zs	0	250	Linear
<Zs	-100	100	Linear
VSWR	1.00	10.00	Log
RL	-20	0	Log
CL	0	10	Log
Rho	0	1.0	Linear
<Rho	-190	190	Linear
%Rp	0	100	Linear
Q	0	20	Linear
Cs	-1000	1000	Linear
Ls	-10	10	Linear
Cp	-1000	1000	Linear
Lp	-10	10	Linear

Default scale presets can be modified by the user by supplying special text files stored on the analyzer's disk. The file names for each of the scales have to be the following:

- «Scale» «Normal» → "scal_def.txt"
- «Scale» «High» → "scal_hig.txt"
- «Scale» «Low» → "scal_low.txt"
- «Scale» «Auto» → "scal_aut.txt"

The files must contain an entry for each parameter with the following syntax:

```
min,max,log {Y,N}
```

Note that logarithmic scales do not accept negative ranges.

Example (file name "scal_def.txt"):

```
10,1000,Y          #Rs
-500,500,N         #Xs
10,1000,Y          #Rp
-500,500,N         #Xp
10,1000,Y          #|Zs|
-100,100,N         #<Zs
1.00,25.00,Y       #VSWR
-40,0,N            #RL
0,20,N             #CL
0,1.0,N            #|Rho|
-190,190,N         #<Rho
0,100,N            #%Rp
0,20,N             #Q
-10000,10000,N     #Cs
-100,100,N         #Ls
-10000,10000,N     #Cp
-100,100,N         #Lp
```

Appendix I: Custom Cable Settings

The SARK-110 allows the user to specify three custom cable settings by supplying a special text file stored on the analyzer's disk. The file name must be "custcab.txt" and the format for each cable entry in the file is as follows:

```
legend, Z0, VF, K0, K1, K2
```

Where:

- legend: string to be display in the preset menu (max length: 20)
- Z0: characteristic impedance
- VF: velocity factor
- K0: DC resistance, dB/100ft
- K1: coefficient for conductor loss, dB/100ft
- K2: coefficient for dielectric loss, dB/100ft

Example:

```
Test cable 1,      50,      0.68, 0.063897,      0.192292,      0.000051
Test cable 2,      60,      0.78, 0.073897,      0.193292,      0.000061
Test cable 3,      70,      0.88, 0.083897,      0.194292,      0.000071
```

Appendix J: Specifications

Feature	SARK-110
LCD	3" Color 400 x 200 pixels
Frequency range	0.1 – 230 MHz 1-Hz resolution +- 30-ppm stability
Output signal shape	Sinusoidal
Output power (measurements)	-10 dBm
Output power (signal generator)	Programmable from -73 dBm to -10 dBm
Test port connector type	MCX (included MCX to SMA adaptor)
Measured parameters	VSWR, Rs, Xs, Rp, Xp, Zs , <Zs, RL, CL, Rho , <Rho, %Ref PWR, Q, Cs, Cp, Ls, Lp
Reactance sign measurement	Yes
Narrowband detectors	Two narrowband detectors Two 12-bit ADCs
Return loss dynamic range	0 to -60 dB
Measurement limits	VSWR < 100:1, Z < 100K, R < 100K, X < 100K, Rho < 0.98, C < 100 nF, L < 100 mH, -180 < θ < 180
Sweep frequency resolution	258 points (258 to 10000 in deep sweep mode) 3-sec sweep time (normal)
Impedance reading in open circuit	60K (@1 MHz)

Internal data memory	2 MB for storage of measurements, screenshots, configuration and firmware upgrades
OSL Calibration	8 Calibration profiles 400 points
USB	<ul style="list-style-type: none"> • Mini-USB connector • Mass Storage class • HID class
Battery	<p>Li-Poly 1000 mAh</p> <p>Internal battery charger</p> <p>2.5-hour autonomy</p> <p>3.5-hour charge</p> <p>Charge via USB</p>
Modes	<ul style="list-style-type: none"> • Scalar chart • Smith chart • Single frequency • Multiband charts • Cable test (TDR) • Signal generator • Band scan
Special functions	<ul style="list-style-type: none"> • Configurable presets for amateur bands • Markers • Save/load data • Save screenshots • Deep sweep save with timer function • VSWR Audible feedback • Transmission line add/subtract • Circuit modes: loop antenna, capacitor, crystal, transmission line • Automatic LC matching calculator
Dimensions	<p>98 * 60 * 14.5 (mm)</p> <p>Weight: 120-g</p>
Package contents	<ul style="list-style-type: none"> • SARK-110 x 1 with built-in battery • MCX to SMA female connector adapter x 1 • SMA plug to SMA female 8" (20-cm) cable adapter x 1

Appendix K: Acknowledgments

- I would like to offer a special thanks to the Seeed Studio team for making this product a reality.
- The analyzer schematics and layout have been developed using the DesignSpark PCB tool. Product information is available at: www.designspark.com/pcb
- The analyzer firmware has been developed using the Lite edition of the Atollic TrueSTUDIO® for STM32. Product information is available at: www.atollic.com
- FAT File System was provided by the ChaN, FatFs module.
- The STM32 firmware and USB library are provided by STMicroelectronics.
- Many thanks to Dan Maguire, AC6LA, for the great ZPLOTS MExcel application: <http://www.ac6la.com/zplots.html>