

# TOKIN Sensors

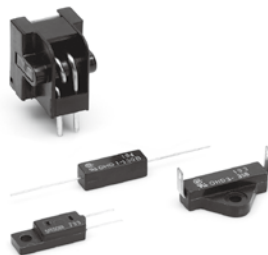

## Vol. 14



- All specifications in this catalog and production status of products are subject to change without notice. Prior to the purchase, please contact TOKIN for updated product data.
- Please request for a specification sheet for detailed product data prior to the purchase.
- Before using the product in this catalog, please read "Precautions" and other safety precautions listed in the printed version catalog.

# CONTENTS

|   |    |
|---|----|
| Thermal Reed Switch TRS™ .....                      | 4  |
| TRS Series Approved by UL, CSA, and VDE .....       | 11 |
| Thermal Guard OHD™ .....                            | 12 |
| Alternating Current Sensor .....                    | 15 |
| Alternating Current Sensor (Snap-on Type) .....     | 17 |
| Zero-Phase Current Transformer ZCT .....            | 18 |
| Magnetic Direct Current Sensor MDCS™ .....          | 20 |
| Magnetic Type Proximity Switches TMRS™ Series ..... | 24 |
| Inquiries .....                                     | 29 |



- All specifications in this catalog and production status of products are subject to change without notice. Prior to the purchase, please contact TOKIN for updated product data.
- Please request for a specification sheet for detailed product data prior to the purchase.
- Before using the product in this catalog, please read "Precautions" and other safety precautions listed in the printed version catalog.

# INTRODUCTION

Advances in LSIs, microcomputers and power devices enable ever more efficient use of energy, finer control and greater ease of use. In this way industry is promoting consumer appliances with increasingly sophisticated "intelligent" functions. And with these developments there is a burgeoning need for advanced, highly reliable sensors with capabilities corresponding to the human's five senses.

TOKIN seeks to commercialize creative products fusing new material technologies with new applications, developing and commercializing a broad range of sensor devices based on outstanding materials technologies covering properties such as magnetism, piezoelectronics and optics.

This catalog introduces different kinds of sensors, including thermosensors, current sensors and magnetic sensors. Besides the items shown here we also offer an extensive line of sensor-related products and are continually developing new sensors, so please feel free to ask us about anything you might need. We look forward to being able to serve you.



- All specifications in this catalog and production status of products are subject to change without notice. Prior to the purchase, please contact TOKIN for updated product data.
- Please request for a specification sheet for detailed product data prior to the purchase.
- Before using the product in this catalog, please read "Precautions" and other safety precautions listed in the printed version catalog.

# Thermal Reed Switch TRS™

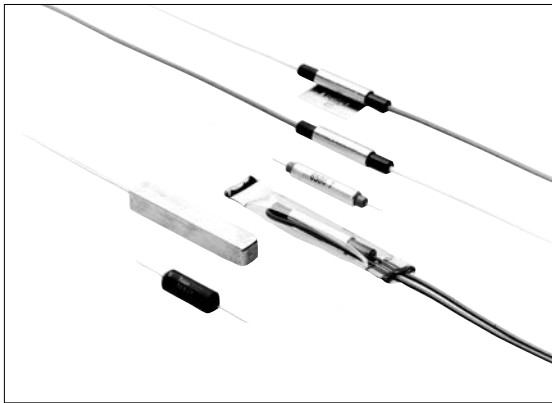

## Outline

TOKIN led the world in recognizing and realizing the potential of ferrite's Curie temperature. The result is Thermorite™, a temperature-sensing magnetic material. Ever since the introduction of this product, TOKIN has reigned as the top manufacturer of Curie-temperature-utilizing control devices, developing many products with new functions. Among these, the Thermal Reed Switch (TRS™) is the chief product, with patents in the United States and Japan. Its superiority as a highly reliable, precise temperature-sensitive switch ideal for promoting energy conservation has been attested to by the International Relay Association. There are already more than 400 million in use, and with the addition of TRS™ varieties approved by UL, CSA and other safety standards, the lineup just keeps getting better.

## Features

- High reliability (long product lifetime)
- Excellent temperature accuracy ( $\pm 2.5^{\circ}\text{C}$ ,  $\pm 1^{\circ}\text{C}$ )
- Wide range of operating temperature available ( $-10^{\circ}\text{C}$  to  $+130^{\circ}\text{C}$ )
- Excellent environmental resistance (contacts are encased in a glass tube)

## Markings

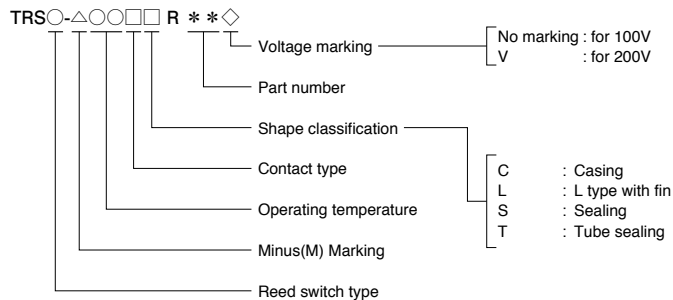

## Electrical Characteristics

| Reed switch type                    | For 100 V    |                  |                  |                  |            | For 200 V   |             |
|-------------------------------------|--------------|------------------|------------------|------------------|------------|-------------|-------------|
|                                     | TRS06-       | TRS1             | TRS3-            | TRS5-            | TRS6-      | TRSS-       | TRS1-       |
| Maximum opening/closing voltage (V) | 110<br>AC·DC | 140 AC<br>200 DC | 140 AC<br>200 DC | 140 AC<br>200 DC | 140<br>AC  | 264<br>AC   | 220<br>AC   |
| Maximum opening/closing current (A) | 0.3<br>AC·DC | 0.5<br>AC·DC     | 0.5<br>AC·DC     | 0.55<br>AC·DC    | 0.65<br>AC | 0.275<br>AC | 0.045<br>AC |
| Maximum opening/closing power (W)   | 6<br>AC·DC   | 10<br>AC·DC      | 35 AC<br>10 DC   | 60.5 AC<br>10 DC | 72<br>AC   | 60.5<br>AC  | 10<br>AC    |

\* Please refer to pages 6 to 7 as rated values vary depending on product types (shape classification).



- All specifications in this catalog and production status of products are subject to change without notice. Prior to the purchase, please contact TOKIN for updated product data.
- Please request for a specification sheet for detailed product data prior to the purchase.
- Before using the product in this catalog, please read "Precautions" and other safety precautions listed in the printed version catalog.

**Structures and Principles of Operation**

Thermal Reed Switches (TRS™) are temperature-sensing switches composed of a magnet and a temperature-sensing soft ferromagnetic substance called Thermorite™. This material's saturation magnetic flux density decreases as the temperature increases, and it turns into a paramagnetic substance at the Curie temperature.

**Temperature sensing ferrite (Thermorite®)**

- ◆ Our self-developed Thermorite is temperature sensing ferrite utilizing Curie-temperature, where ferrites lose its magnetic property. Thermorite changes its magnetic property rapidly at Curie-temperature.
- ◆ Features of Thermorite as temperature sensing material.
  - (1) Curie-temperature do not vary as time advances, because it depends on compounding ratio.
  - (2) Arbitrary shape available as ceramics.
  - (3) Stable against moist or hazardous gas.

Thermal property of Thermorite

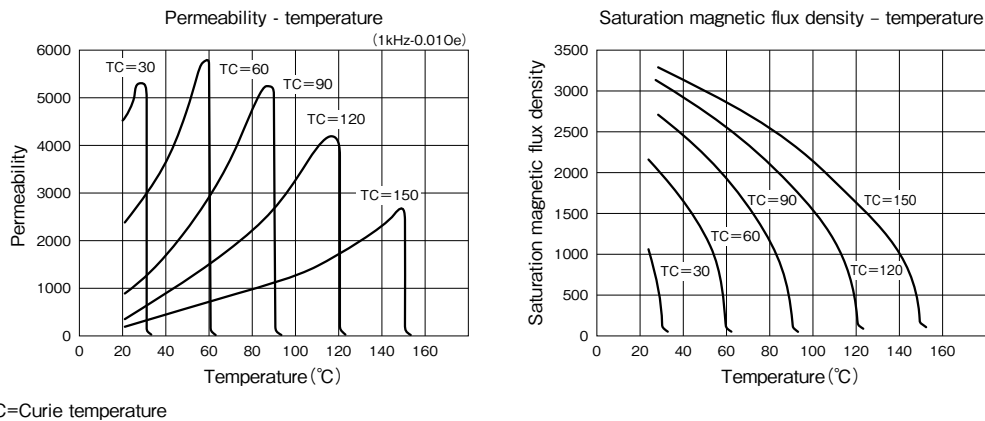

**Structure of reed switch**

- ◆ Reed switch is contact switch comprised of a pair of Fe-Ni alloy reeds encased in glass tube with inactive gas. The reeds are switched on or off by magnetic field of permanent magnet or magnet coil.
- ◆ Long lifetime, High environmental resistance because of protected contact by glass encasing.
- ◆ Reeds in glass tube become magnetized with magnetic field, and then two reeds contact and connect each other (switch on). And then magnetic field disappears, the reeds separate and disconnect (switch off).

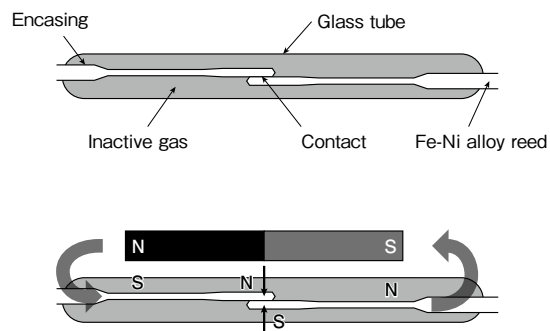

● All specifications in this catalog and production status of products are subject to change without notice. Prior to the purchase, please contact TOKIN for updated product data.  
 ● Please request for a specification sheet for detailed product data prior to the purchase.  
 ● Before using the product in this catalog, please read "Precautions" and other safety precautions listed in the printed version catalog.

**TRS principle : Break (B) type**

( ■: Permanent magnet   ■: Thermorite®   ■: Reed switch contact area )

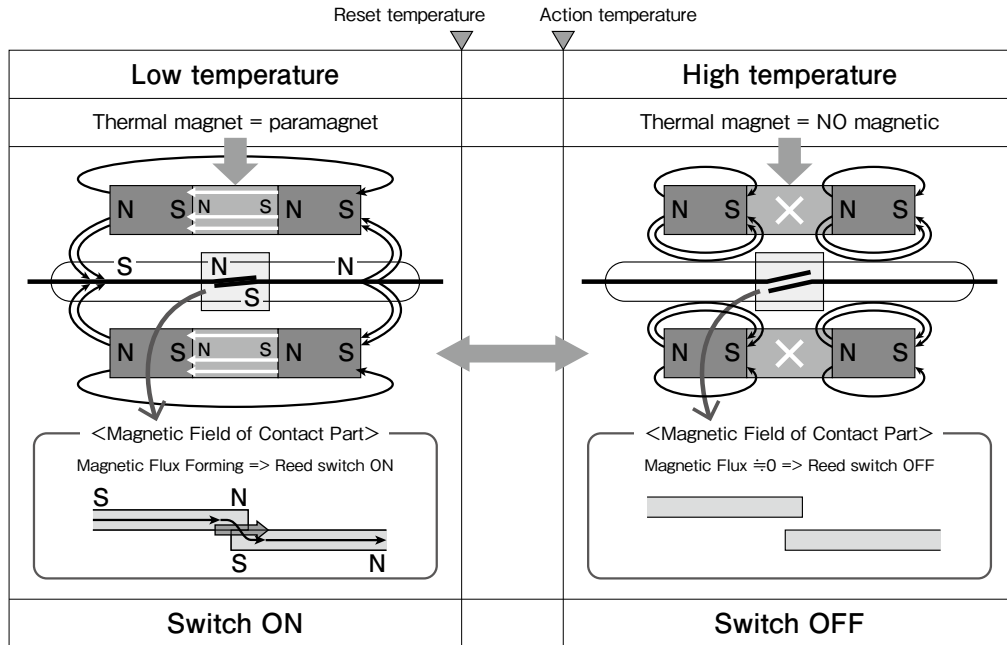

**TRS principle : Make (M) type**

( ■: Permanent magnet   ■: Thermorite®   ■: Gapspace (SP)   ■: Reed switch contact area )

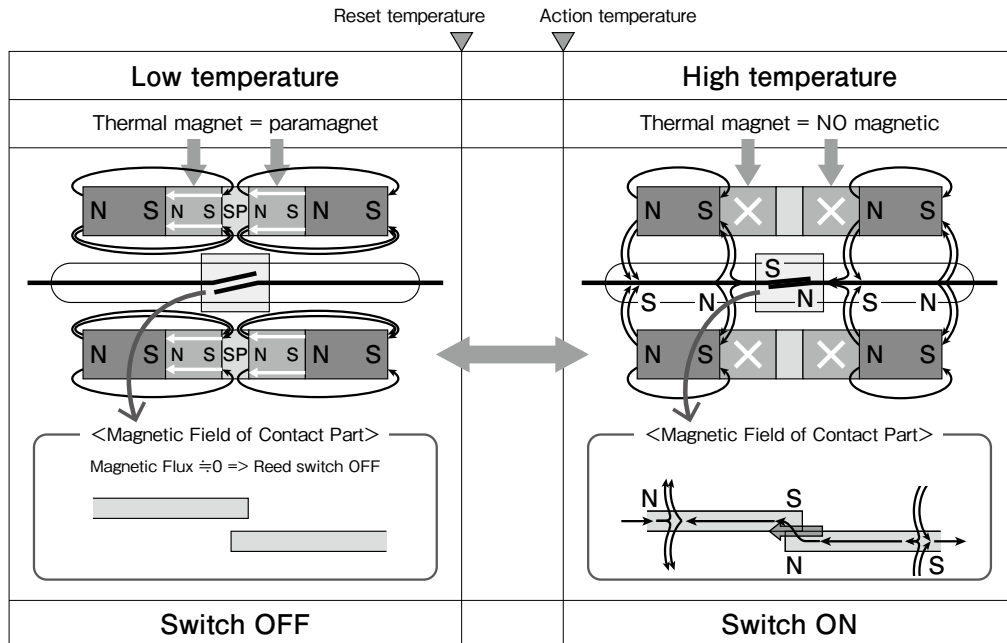

- All specifications in this catalog and production status of products are subject to change without notice. Prior to the purchase, please contact TOKIN for updated product data.
- Please request for a specification sheet for detailed product data prior to the purchase.
- Before using the product in this catalog, please read "Precautions" and other safety precautions listed in the printed version catalog.

**External magnetic field**

TRS/OHD installation direction in external magnetic field

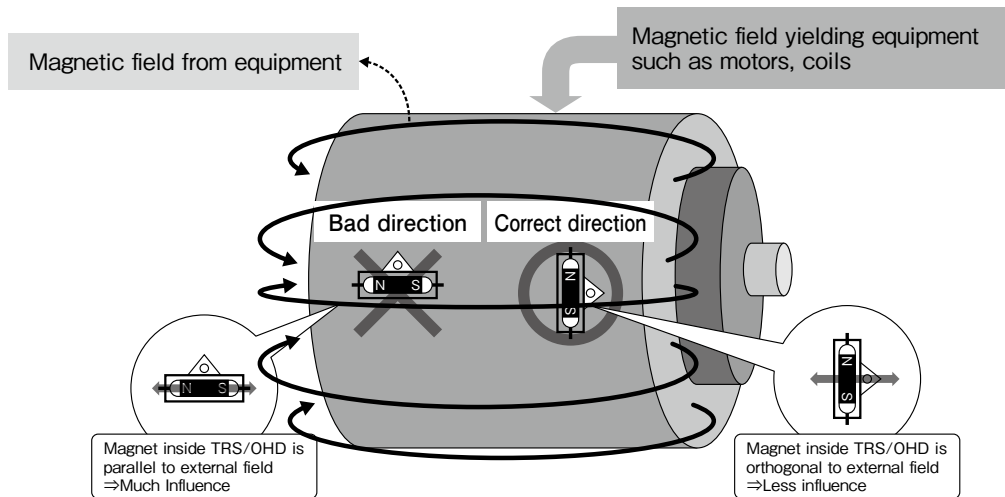

**Ferromagnetic material influence**

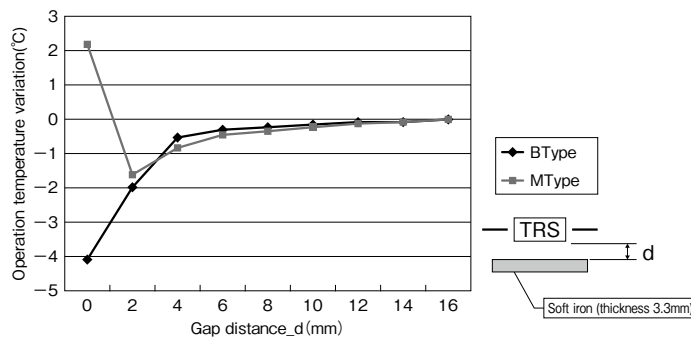

Note: Above figures are for reference only and are not guaranteed values.

**Before Using Thermal Reed Switch (TRS™)**

- Please ask for a copy of specification and check the contents thoroughly before the actual use.
- Please contact us before deciding your specifications.
- Do not use in close proximity to strongly magnetized parts.
- Do not use if dropped or strongly shocked.
- Do NOT use with greater load than specified.

When installing these switches in circuits prone to producing surge voltage (inductive load) or rush current (in lamps and motors), an appropriate switch type should be used, or a contact point protection circuit added.

- Avoid stress (especially torsion) in case of additional processing.
- Each reed switch has a specific resonance frequency. Please contact us when an oscillation is added.



● All specifications in this catalog and production status of products are subject to change without notice. Prior to the purchase, please contact TOKIN for updated product data.  
 ● Please request for a specification sheet for detailed product data prior to the purchase.  
 ● Before using the product in this catalog, please read "Precautions" and other safety precautions listed in the printed version catalog.

## Temperature sensors supported specifications by type

○ : Supported    × : Not supported

| Series           | Shape                   | Supported specifications   | Operating temperature range  | Operating temperature precision<br>(Does not include measurement error) | Certifications   | Break (B) | Make (M) |
|------------------|-------------------------|--|--|---|------------------|-----------|----------|
| TRS <sup>®</sup> | Compact Type            | TRS06-**BLR001<br>TRS06-**BCR001   | 30 ~ 130°C   | ± 5°C   | —                | ○         | ×        |
|                  | CType                   | TRS1-**MCR00V, 01V<br>TRS3-**MCR00, 01<br>TRS5-**BCR00, 00V, 01, 01V     | 0 ~ 120°C  | ± 2.5°C   | —                |           | ○        |
|                  | LType                   | TRS1-**MLR00V<br>TRS3-**MLR00<br>TRS5-**BLR00, 00V                       | 0 ~ 130°C  | ± 2.5°C   | —                |           | ○        |
|                  | SType<br>(Sealing)      | TRS1-**MSR00V, 01EV<br>TRS3-**MSR00, 01E<br>TRS5-**BSR00, 00V, 01E, 01EV | -10 ~ 100°C  | ± 2.5°C   | —                |           | ○        |
|                  | TType<br>(Tube sealing) | TRS1-**MTR01V<br>TRS3-**MTR01<br>TRS5-**BTR01, 01V                       | -10 ~ 60°C   | ± 2.5°C   | —                |           | ○        |
|                  | Mold TRS<br>Type        | M-TRS5-**B   | -10 ~ 130°C  | ± 2.5°C   | —                |           | ×        |
|                  | Approved by<br>UL       | TRS5-**BCR01U, 01VU<br>TRS5-**BLRU, VU                                   | Shape A : 0 ~ 120°C<br>Shape B : 0 ~ 130°C   | ± 2.5°C   | UL               |           | ×        |
|                  | Approved by<br>CSA      | TRS5-**BLRU, XU  | Shape B : 0 ~ 129°C  | ± 2.5°C   | CSA              |           | ×        |
| OHD <sup>™</sup> | OHD1                    | OHD1-**B, M  | 5°C increments between<br>30°C and 130°C<br>(the standard temperature<br>range is 35°C to 120°C) | ± 5°C   | UL<br>CSA<br>TUV | ○         | ○        |
|                  | OHD3                    | OHD3-**B, M  |  |   |                  |           | ×        |
|                  | OHD5R                   | OHD5R-**B  |  |   |                  |           | ×        |



- All specifications in this catalog and production status of products are subject to change without notice. Prior to the purchase, please contact TOKIN for updated product data.
- Please request for a specification sheet for detailed product data prior to the purchase.
- Before using the product in this catalog, please read "Precautions" and other safety precautions listed in the printed version catalog.

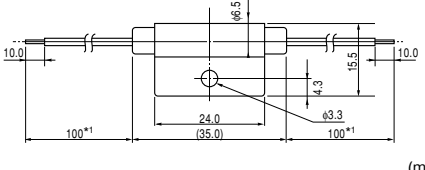
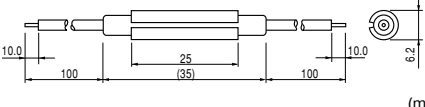
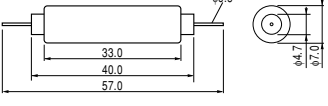
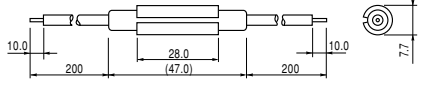
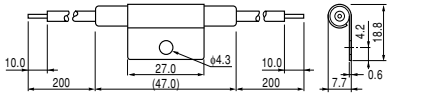

|                     | Part Number / Shape / Dimensions   | Operating temperature range <sup>1</sup> | Operating temperature precision <sup>3</sup> | Differential Temperature <sup>4</sup> | Application(s)  | Features        |
|---------------------|--|--|--|---------------------------------------|---|-----------------|
| Compact Type        | <ul style="list-style-type: none"> <li>● TRS06-○ BLR001</li> </ul>    | 30°C to 130°C                            | ± 5°C  | 10°C max.                             | Power supplies<br>Recharge<br>temperature detection                 | Compact         |
|                     | <ul style="list-style-type: none"> <li>● TRS06-○ BCR001</li> </ul>    |  |  |                                       |   |                 |
| C Type              | <ul style="list-style-type: none"> <li>● TRS5-○ BCR01</li> <li>● TRS5-○ BCR01V</li> <li>● TRS1-○ MCR01V</li> <li>● TRS3-○ MCR01</li> </ul>  | 0°C to 120°C                             | ± 2.5°C                                      | 10°C max.                             | Rice cookers<br>Yogurt makers<br>Hot water heaters<br>Photocopiers  | General-purpose |
|                     | <ul style="list-style-type: none"> <li>● TRS5-○ BCR00, 00V</li> <li>● TRS3-○ MCR00, TRS1-○ MCR00V</li> </ul>                               |  |  |                                       |   |                 |
| L Type (Break Type) | <ul style="list-style-type: none"> <li>● TRS5-○ BLR00</li> <li>● TRS5-○ BLR00V</li> </ul>   | 0°C to 130°C                             | ± 2.5°C                                      |                                       | Rice cookers<br>Hot water heaters<br>Thermos-type hot water heaters | General-purpose |

\*1 Please consult us before you determine specifications.  
 \*2 Please contact us with questions regarding operating temperature precision.  
 \*3 Operating temperature precision does not include measurement error.  
 \*4 Difference between operating temperature and return temperature.  
 \*5 All specifications comply with RoHS directive.

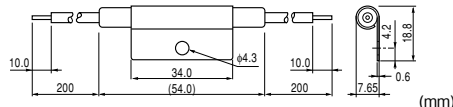
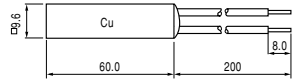
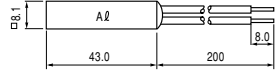
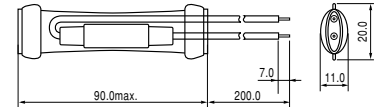
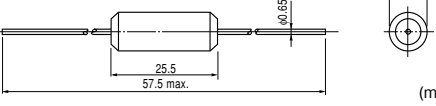
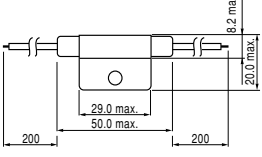

● All specifications in this catalog and production status of products are subject to change without notice. Prior to the purchase, please contact TOKIN for updated product data.  
 ● Please request for a specification sheet for detailed product data prior to the purchase.  
 ● Before using the product in this catalog, please read "Precautions" and other safety precautions listed in the printed version catalog.

|                                      |   |                       |                |                  |   |  |
|--------------------------------------|---|-----------------------|----------------|------------------|---|--|
| <p><b>L Type<br/>(Make Type)</b></p> | <p>● TRS3-○○MLR00, TRS1-○○MLR00V</p>   | <p>0°C to 130°C</p>   | <p>± 2.5°C</p> |                  | <p>Power supplies<br/>Computers &amp; peripherals</p>   | <p>General-purpose</p>                             |
| <p><b>S Type<sup>1</sup></b></p>     | <p>● TRS5-○○BSR00, 00V<br/>● TRS3-○○MSR00, TRS1-○○MSR00V</p>  <p>● TRS5-○○BSR01E, 01EV<br/>● TRS3-○○MSR01E, TRS1-○○MSR01EV</p>  | <p>-10°C to 100°C</p> | <p>± 2.5°C</p> |                  | <p>Air-conditioners<br/>Freezers<br/>Vending machines<br/>Refrigerators<br/>Anti-freeze heaters</p> | <p>Humidity-and moisture-resistant</p>             |
| <p><b>T Type<sup>1</sup></b></p>     | <p>● TRS5-○○BTR01, 01V<br/>● TRS3-○○MTR01, TRS1-○○MTR01V</p>   | <p>-10°C to 60°C</p>  | <p>± 2.5°C</p> | <p>10°C max.</p> |   |  |
| <p><b>Mold TRS Type</b></p>          | <p>● M-TRS5-○○B</p>   | <p>-10°C to 130°C</p> | <p>± 2.5°C</p> |                  | <p>Anti-freeze heaters<br/>Aquarium heaters</p>   | <p>Molded plastic</p>                              |
| <p><b>Approved by UL, CSA</b></p>    | <p>● TRS5-○○BLRU</p>   | <p>0°C to 130°C</p>   | <p>± 2.5°C</p> |                  | <p>Photocopiers<br/>Rice cookers</p>  | <p>Satisfies overseas safety standards-UL, CSA</p> |



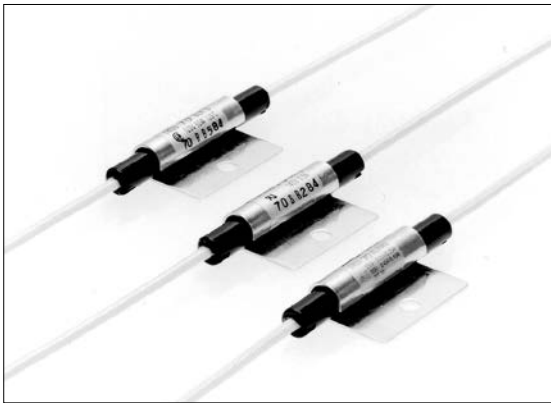

- All specifications in this catalog and production status of products are subject to change without notice. Prior to the purchase, please contact TOKIN for updated product data.
- Please request for a specification sheet for detailed product data prior to the purchase.
- Before using the product in this catalog, please read "Precautions" and other safety precautions listed in the printed version catalog.

# TRS™ Series Approved by UL, CSA, and VDE



## Specifications

| Recognized by:  | Model   | Max.Make/Break Current      | Max.Make/Break Voltage | Max.Make/Break Power | Shape No. | Set Operating Temperature Range (°C) | Operating Temperature precision (°C) | Differential Temperature (°C) <sup>1</sup> |         |
|---|---|-----------------------------|------------------------|----------------------|-----------|--------------------------------------|--------------------------------------|--|---------|
|    | BCR Series<br>TRS5-○○○BCR01U  | 0.5A                        | 140V AC                | 50W AC               | A         | 0~120                                | ±2.5                                 | 10 max.                                    |         |
|   | TRS5-○○○BCR01VU   | 0.275A                      | 264V AC                | 60.5W AC             |           |                                      |                                      |  |         |
|   |  | BLR Series<br>TRS5-○○○BLR U | 0.5A                   | 140V AC              | 50W AC    | B                                    | 0~130                                | ±2.5                                       | 10 max. |
|   |   | TRS5-○○○BLR VU              | 0.275A                 | 264V AC              | 60.5W AC  |                                      |                                      |  |         |
|  | BLR Series<br>TRS5-○○○BLR U   | 0.5A                        | 120V AC                | 50W AC               | B         | 0~129                                | ±2.5                                 | 10 max.                                    |         |
|   | TRS5-○○○BLR XU  | 0.25A                       | 240V AC                | 60W AC               |           |                                      |                                      |  |         |

UL : File No.E67648  
CSA : File No.LR50414-2

<sup>1</sup>No values specified in the international safety standard.  
\*○○○ indicates the operating temperature

## Shape and Dimensions

● A

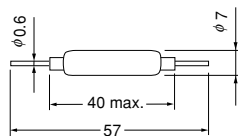

● B

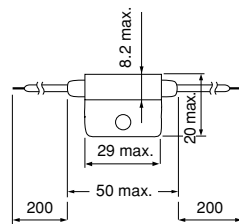

[mm]



- All specifications in this catalog and production status of products are subject to change without notice. Prior to the purchase, please contact TOKIN for updated product data.
- Please request for a specification sheet for detailed product data prior to the purchase.
- Before using the product in this catalog, please read "Precautions" and other safety precautions listed in the printed version catalog.

# Thermal Guard OHD™

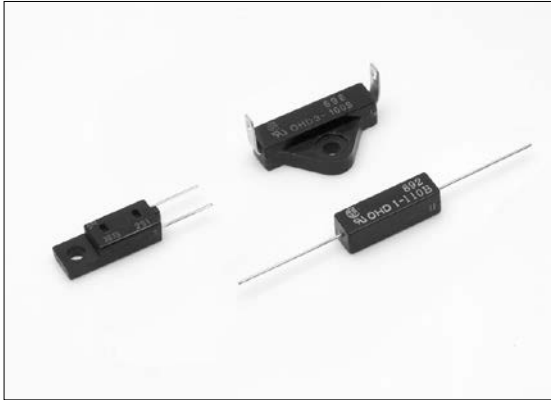

## Features

- Extremely simple circuit design (as no adjustment needed).
- Reliable ON-OFF operation (special temperature-sensitive materials and highly-reliable switches give reproducible, reliable ON-OFF action).
- Usable with extremely low (0.1 mW or lower) signals to high power (6 W) levels, making them ideal as built-in overheating detectors in electronic circuits. (OHD5R- ○○B have a maximum rating of 1 W.)
- High-speed response (three times higher than previous TOKIN products).
- Compact, light and easy to handle.
- Dust-proof, explosion-proof, and corrosion-proof.
- Wide range of operating temperatures available (in 5 °C increments from 30 to 130 °C)

## Outline

The thermal guard “OHD™” is developed for thermal problem countermeasures and safety standard conformity that are becoming increasingly important for electronic devices in recent years.





## Applications

- Monitoring overheating of power transistors and power modules in power supplies, OA equipment and other electronic appliances.
- Atmospheric temperature detection and overheating monitoring in room heaters, gas hot water heaters, PPCs, amplifiers, motors, HDDs, FDDs and other general appliances.



- All specifications in this catalog and production status of products are subject to change without notice. Prior to the purchase, please contact TOKIN for updated product data.
- Please request for a specification sheet for detailed product data prior to the purchase.
- Before using the product in this catalog, please read "Precautions" and other safety precautions listed in the printed version catalog.

**Specifications**

| Product name   | Features   | Contact shape     | Electrical Characteristics   | Set operating temperature range <sup>*1</sup> | Operating temperature precision <sup>*2</sup> | Differential temperature |
|--|--|-------------------|--|---|---|--------------------------|
| OHD1-   | <br>General-purpose     | B:Break<br>M:Make | Maximum opening/closing voltage 110 V AC/DC<br>Maximum opening/closing current 0.3 A AC/DC<br>Maximum opening/closing power 6 W AC/DC<br>Minimum opening/closing current 0.1mA/1V,DC | Fixed in 5°C increments from 30°C to 130°C    | ± 5°C   | 10°C max.                |
| OHD3-   |  |                   | Maximum opening/closing voltage 30 V.DC<br>Maximum opening/closing current 0.1 A DC<br>Maximum opening/closing power 1 W DC<br>Minimum opening/closing current 0.1mA/1V,DC           |   |   |                          |
| OHD5R-  | <br>Compact radial type | B:Break           |  |   |   |                          |

UL : E67648  
 CSA : LR50414  
 TUV : OHD1 · 3 R 9750955  
 OHD5R R 9750944

\*1 Please consult us before you determine specifications.  
 \*2 Operating temperature precision does not include measurement error.

| Product name | Contact Resistance | Insulation Withstand Voltage  | Insulation Resistance   | Remarks                      |
|--------------|--------------------|---|---|------------------------------|
| OHD1-3       | 150mΩ max.         | 2500VAC/1min. or 3000VAC/1sec<br>(Between terminals and mounting resin surface) | DC500V-100MΩ min.<br>(Between terminals and mounting resin surface) | Compliance to RoHS directive |
| OHD5R        | 300mΩ max.         | 1500VAC/1min. or 1800VAC/1sec<br>(Between terminals and mounting resin surface) | DC500V-100MΩ min.<br>(Between terminals and mounting resin surface) | Compliance to RoHS directive |

**Standard Temperature Specifications**

| Product name | Standard temperature specification                                       |
|--------------|--|
| OHD3-B       | 35, 40, 45, 50, 55, 60, 65, 70, 75, 80, 85, 90, 95, 100, 105, 110, 120°C |
| OHD3-M       | 35, 40, 45, 50, 55, 60, 65, 70, 75, 80, 85, 90, 95, 100, 105, 110, 120°C |
| OHD5R-B      | 35, 40, 45, 50, 55, 60, 65, 70, 75, 80, 85, 90, 95, 100, 105, 110, 120°C |

\* Please ask separately except standard temperature specification

**Standard package unit**

| Product name | Standard package unit (pcs.) |
|--------------|------------------------------|
| OHD1-B, M    | 1,200                        |
| OHD3-B, M    | 1,000                        |
| OHD5R-B      | 700                          |

\* Please inquire regarding quantities below the standard package unit.

**Markings**

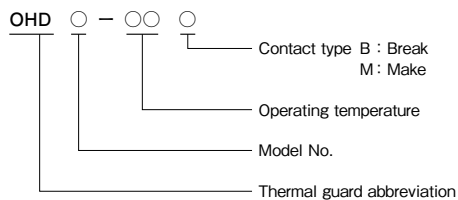

- All specifications in this catalog and production status of products are subject to change without notice. Prior to the purchase, please contact TOKIN for updated product data.
- Please request for a specification sheet for detailed product data prior to the purchase.
- Before using the product in this catalog, please read "Precautions" and other safety precautions listed in the printed version catalog.

## Shape and Dimensions

### ● OHD1

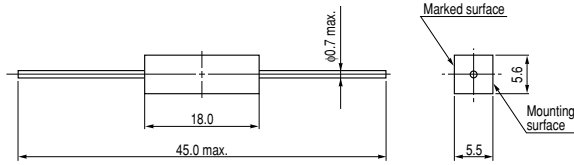

### ● OHD1 mounting bracket

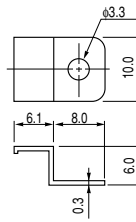

\*Mounting brackets exclusively for the OHD1 type are provided optionally (at separate cost).

### ● OHD3

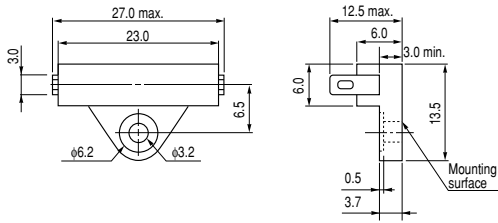

### ● OHD5R

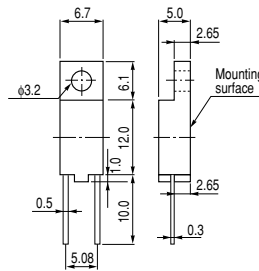

(mm)

### Before Using Thermal Guard OHD™

- Please ask for a copy of specification and check the contents thoroughly before the actual use.
- Do not use OHD™ under mechanical weight load.
- Do NOT use with greater load than specified.
- Do not affix in close proximity to strongly magnetized parts and avoid using in a magnetic field.
- Do not use if dropped or strongly shocked.
- The OHD1 and OHD5R are designed to be inserted into printed circuit boards. OHD3 type is reed wire soldered type.



- All specifications in this catalog and production status of products are subject to change without notice. Prior to the purchase, please contact TOKIN for updated product data.
- Please request for a specification sheet for detailed product data prior to the purchase.
- Before using the product in this catalog, please read "Precautions" and other safety precautions listed in the printed version catalog.

# Alternating Current Sensor

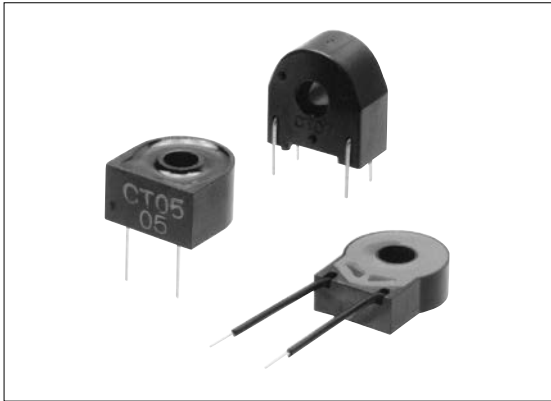

## Outline

This series of compact current transformers (current sensors) can be used for detecting very low current levels and overcurrent protection in electronic appliances.

## Features

- High sensitivity (detection of low current) and high performance.
- Compact, lightweight.
- Mountable on printed circuit boards.

## Applications

- Overcurrent detection in microcomputer-controlled equipment.
- Current detection in electric refrigerators, air conditioners and electromagnetic cookers.

## Specifications

| Product name | CT-05                             | CT-06                                    | CT-07                             |
|--------------|-----------------------------------|--|-----------------------------------|
| Core         | Permalloy                         | Permalloy                                | Permalloy                         |
| Lead wires   | φ 0.6 mm Pin connectors           | Polyethylene sheath φ 0.5 mm single wire | φ 0.8 mm Pin connectors           |
| Materials    | Phenolic resin case, epoxy-filled | Phenolic resin case, silicon-filled      | Phenolic resin case, epoxy-filled |
| Remarks      | Compliance to RoHS directive      | Compliance to RoHS directive             | Compliance to RoHS directive      |

- Notes: (1) The CT-05 has 500<sup>T</sup> as standard.  
 (2) In the standard lineup there are three types of CT-06, depending on differences in secondary windings.  
 (3) In the standard lineup there are two types of CT-07, depending on differences in secondary windings.

## Shape and Dimensions

### ● CT-05

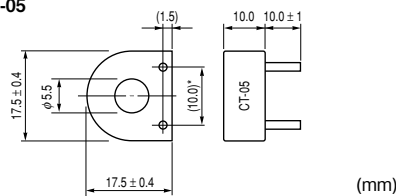

### ● CT-06

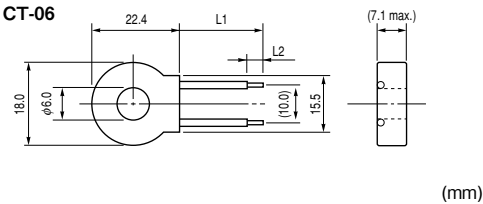

### ● CT-07

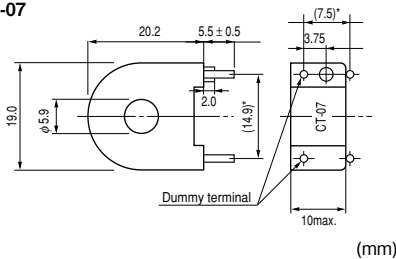

| Product name | L1(±5) | L2(±2) |
|--------------|--------|--------|
| CT-06-50     | 56.0   | 4.0    |
| CT-06-75     |        |        |
| CT-06-100    | 85.0   | 5.0    |

- \* Tolerance ±0.3  
 \* Pin root diameter.



- All specifications in this catalog and production status of products are subject to change without notice. Prior to the purchase, please contact TOKIN for updated product data.
- Please request for a specification sheet for detailed product data prior to the purchase.
- Before using the product in this catalog, please read "Precautions" and other safety precautions listed in the printed version catalog.

## Output Characteristics

### ● CT-05, CT-07 AC output characteristics (example)

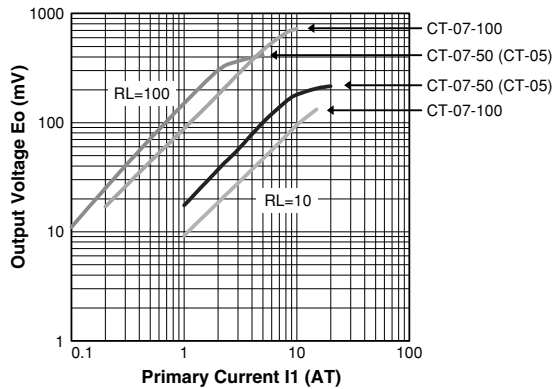

### ● CT-06 AC output characteristics (example)

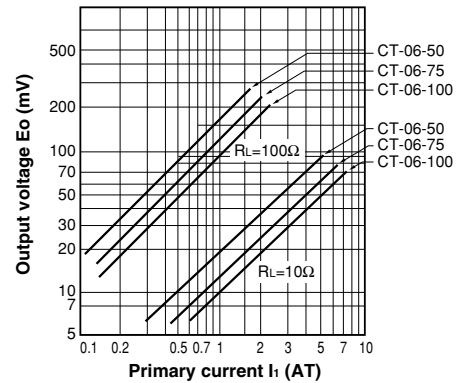

### ● Measuring circuit

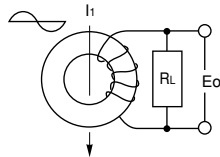

$I_1$  : Primary current (AT)  
 $R_L$  : Load resistance ( $\Omega$ )  
 $E_o$  : Output voltage (mV rms)

### Before Using Alternating Current Sensor

- The core may be damaged if applied with a strong impact. Carefully avoid dropping or applying any other strong impacts.
- Preliminary study is needed with regard to heating by current conduction.
- Do not use the current transformer opened between secondary output terminals.  
In the worst case, heat build-up in the magnetic core may occur, resulting in damages to the parts by the melting of coil due to this heat.



- All specifications in this catalog and production status of products are subject to change without notice. Prior to the purchase, please contact TOKIN for updated product data.
- Please request for a specification sheet for detailed product data prior to the purchase.
- Before using the product in this catalog, please read "Precautions" and other safety precautions listed in the printed version catalog.



# Alternating Current Sensor (Snap-on Type) C/CT-1216 [RoHS Compliant]



### Outline

This clamp-on current sensor can be used to measure currents in live wires.

### Features

- Compact, slim.
- High performance from its unique design
- Flat temperature characteristics
- Flame retardant

### Applications

- xEMS current measurement
- High performance distribution boards
- Industrial machineries

### Specifications

| Item                         | Unit | Specifications | Comments             |
|------------------------------|------|----------------|----------------------|
| Rated current                | Arms | 120            | 50Hz/60Hz            |
| Applicable current           | Arms | 0.1 ~ 120      | 50Hz/60Hz            |
| Output voltage               | mV   | 1000+/- 20     | Io=50A RL=60Ω f=50Hz |
| Current transformation ratio |      | 3000           |                      |
| Output protection            | V    | 7.5 V          |                      |
| Insulation resistance        | MΩ   | ≥ 100          | DC500V               |
| Operating temperature range  | °C   | -20 ~ +60      |                      |
| Storage temperature range    | °C   | -20°C ~ +80°C  |                      |

### Shape and Dimensions

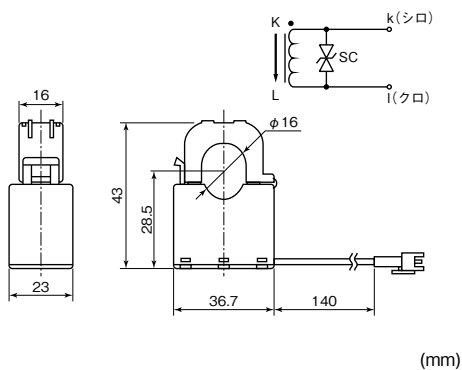

### Output Characteristics

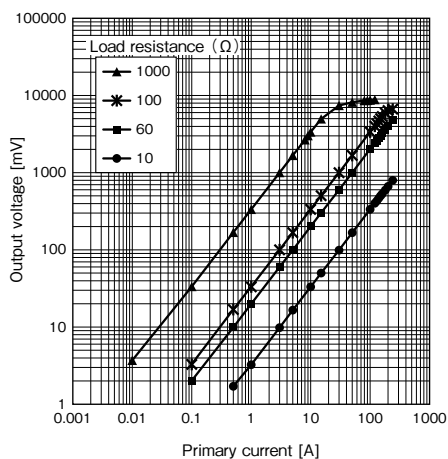

- All specifications in this catalog and production status of products are subject to change without notice. Prior to the purchase, please contact TOKIN for updated product data.
- Please request for a specification sheet for detailed product data prior to the purchase.
- Before using the product in this catalog, please read "Precautions" and other safety precautions listed in the printed version catalog.

# Zero-Phase Current Transformers ZCT

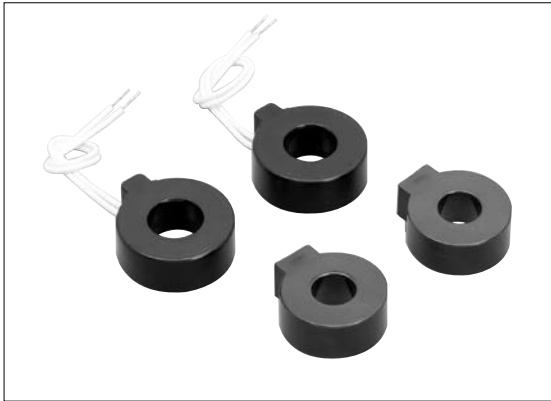

### Outline

The ZCT Series of compact molded-type zero-phase current transformers is ideal for improving the sensitivity, compactness and light weight of electric shock prevention earth leakage breakers.

### Features

- High sensitivity.
- Compact and light weight.
- Laminated iron core type.

### Applications

- Electric shock prevention earth leakage breakers.
- Short circuit relays.

### Shape and Dimensions

● MR-1、2、3、4

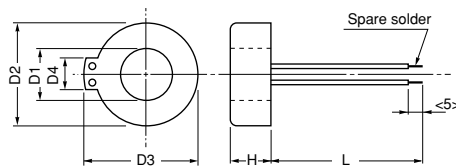

● MR-1-P5

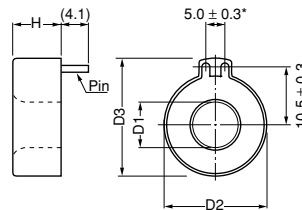

| Product name | Each part's dimensions (mm) |          |          |       |         |           |
|--------------|-----------------------------|----------|----------|-------|---------|-----------|
|              | D1 (min)                    | D2 (max) | D3 (max) | D4    | H (max) | L (± 3.0) |
| MR-1         | 7.2                         | 19.3     | 22.4     | (5.0) | 8.3     | 45.0      |
| MR-2         | 8.9                         | 21.8     | 24.7     | (5.0) | 8.3     | 80.0      |
| MR-3         | 11.0                        | 28.0     | 30.5     | (6.0) | 10.5    | 67.0      |
| MR-4         | 16.5                        | 32.0     | 34.5     | (7.0) | 10.8    | 67.0      |
| MR-1-P5      | 7.4                         | 19.3     | 21.8     | (8.0) | 8.5     | —         |

Pin :  $\phi$  0.8 mm Pin connectors.  
\* Pin root diameter.

### Specifications

| Product name | Output voltage (mV) min. | Temperature characteristics (-20°C~80°C) (%) | Overinput characteristics (After DC5A input) (%) max. | Measurement conditions                      | Remarks                      |
|--------------|--------------------------|--|---|---|------------------------------|
| MR-1         | 8                        | ± 10   | 10  | f=60Hz<br>R=300Ω<br>I <sub>o</sub> =22.5 mA | Compliance to RoHS directive |
| MR-2         |                          |  |   |   |                              |
| MR-3         |                          |  |   |   |                              |
| MR-4         |                          |  |   |   |                              |
| MR-1-P5      |                          |  |   |   |                              |

Notes1: We can accommodate other specifications as well, so please ask if required.  
Notes2: As rated current may vary depending on mounting condition, it is necessary to check its value after the actual mounting on to the component.

R : Load resistance  
I<sub>o</sub> = I<sub>o</sub> : Detection current



- All specifications in this catalog and production status of products are subject to change without notice. Prior to the purchase, please contact TOKIN for updated product data.
- Please request for a specification sheet for detailed product data prior to the purchase.
- Before using the product in this catalog, please read "Precautions" and other safety precautions listed in the printed version catalog.

**Before Using Zero-Phase Current Transformers ZCT**

- Strong shocks such as from being dropped may change the characteristics. Take care to avoid any subjecting the transformers to physical shocks.
- Do not use the current transformer opened between secondary output terminals.  
In the worst case, heat build-up in the magnetic core may occur, resulting in damages to the parts by the melting of coil due to this heat.
- ZCT can be used as current transformer. In this case, please request us for data.



- All specifications in this catalog and production status of products are subject to change without notice. Prior to the purchase, please contact TOKIN for updated product data.
- Please request for a specification sheet for detailed product data prior to the purchase.
- Before using the product in this catalog, please read "Precautions" and other safety precautions listed in the printed version catalog.

# Magnetic Direct Current Sensor MDCS™

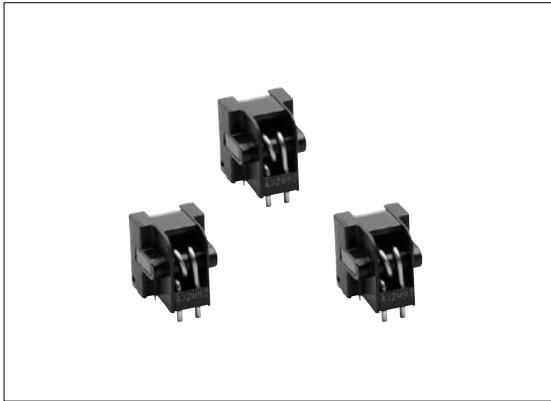

## Outline

Magnetic direct current sensors (MDCS™) use a magnetic substance and hole device for magnetic detection of direct current. They detect all currents (DC, AC and pulse), and the output voltage varies in proportion to the strength of the current measured.

## Features

- Detection of both direct currents and alternating currents (including pulse currents)
- Fluctuations in output from changes in the power supply voltage and the ambient temperature are small.
- Excellent linearity of measured current and the converted power output
- The measured current and the secondary output side are insulated.

## Applications

- Inverter-based home appliances (Air-conditioners etc.)
- General-purpose inverters
- AC variable-speed drive and servo drive
- Industrial machines • UPS • DC motor control
- FAX and other multifunction telephone series (THS Series)

| Item                                     | Marking | Rated value and conditions (Ta=25°C)                            |                     |       |       |                     |       |       |       |                     |       |       |       |       |  |
|--|---------|---|---------------------|-------|-------|---------------------|-------|-------|-------|---------------------|-------|-------|-------|-------|--|
|  |         | Amplifier built-in type   |                     |       |       |                     |       |       |       |                     |       |       |       |       |  |
|  |         | Single power supply operating type (Magnetic proportion system) |                     |       |       |                     |       |       |       |                     |       |       |       |       |  |
|  |         | LA12  |                     |       |       |                     |       |       |       |                     |       |       |       |       |  |
| Model                                    |         | 10V21   | 12V21 <sup>*1</sup> | 15V21 | 20V21 | 24V21 <sup>*1</sup> | 25V21 | 30V21 | 32V21 | 36V21 <sup>*1</sup> | 40V21 | 48V21 | 50V21 | 60V21 |  |
| Rated current (A)                        | IcL1    | ±10   | ±12                 | ±15   | ±20   | ±24                 | ±25   | ±30   | ±32   | ±36                 | ±40   | ±48   | ±50   | ±60   |  |
| Primary side windings (Turn)             | —       | 6   | 6                   | 4     | 3     | 3                   | 2     | 2     | 2     | 2                   | 2     | 2     | 2     | 1     |  |
| Scope of measurement                     | —       | 0 to 100% of rated current (IcL1)                               |                     |       |       |                     |       |       |       |                     |       |       |       |       |  |
| Power supply voltage (V)                 | Vcc     | +12 ±5%   |                     |       |       |                     |       |       |       |                     |       |       |       |       |  |
|  | Vee     | —   |                     |       |       |                     |       |       |       |                     |       |       |       |       |  |
| Consumption current (mA) max.            | —       | 40  |                     |       |       |                     |       |       |       |                     |       |       |       |       |  |
| Output voltage (V)                       | Vh      | +2.000 ±0.060 (at IcL1, RL = 10KΩ)                              |                     |       |       |                     |       |       |       |                     |       |       |       |       |  |
| Residual voltage (V)                     | Voff    | ±2.500 ±0.060 (at 0A, RL = 10KΩ)                                |                     |       |       |                     |       |       |       |                     |       |       |       |       |  |
| Hysteresis (mV) max.                     | Vhys    | 60  |                     |       |       |                     |       |       |       |                     |       |       |       |       |  |
| Power supply voltage variation (mV) max. | —       | 30 (Vcc = +12V ±5%)   |                     |       |       |                     |       |       |       |                     |       |       |       |       |  |
| Vh temperature characteristics (%/°C)    | —       | ±0.15   |                     |       |       |                     |       |       |       |                     |       |       |       |       |  |
| Voff temperature characteristics (mV/°C) | —       | ±4  |                     |       |       |                     |       |       |       |                     |       |       |       |       |  |
| Pulse response (μs) max.                 | Tp      | 20 (di/dt = 100AT/μs)   |                     |       |       |                     |       |       |       |                     |       |       |       |       |  |
| Linearity (%)                            | g       | -2 to 2   |                     |       |       |                     |       |       |       |                     |       |       |       |       |  |
| Insulation withstand voltage             | —       | AC2000V / 1min. (Between wire and terminals)                    |                     |       |       |                     |       |       |       |                     |       |       |       |       |  |
| Insulation resistance                    | —       | 500MΩ / DC500V (Between wire and terminals)                     |                     |       |       |                     |       |       |       |                     |       |       |       |       |  |
| Operating temperature range (°C)         | Ta      | -10 to +75  |                     |       |       |                     |       |       |       |                     |       |       |       |       |  |
| Storage temperature range (°C)           | Ts      | -15 to +80  |                     |       |       |                     |       |       |       |                     |       |       |       |       |  |

\*1 Sample delivery for this model may take extra time.



- All specifications in this catalog and production status of products are subject to change without notice. Prior to the purchase, please contact TOKIN for updated product data.
- Please request for a specification sheet for detailed product data prior to the purchase.
- Before using the product in this catalog, please read "Precautions" and other safety precautions listed in the printed version catalog.

● THS56,56F,65,63F

Electrical Characteristics (Ta=25°C , Vcc=+5V)

| Item                                   |               | Marking                | Conditions                                   | Rating |      |      | Comments    |
|--|---------------|------------------------|--|--------|------|------|-------------|
|  |               |                        |  | min.   | typ. | max. |             |
| Sensitivity current (mA)               | 56,65         | I <sub>L</sub>         | Ta=+5°C~+45°C                                | 2      |      | 15   |             |
|  |               | I <sub>H</sub>         |  |        |      |      |             |
|  | 56F,63F       | I <sub>L</sub>         |  | 5      |      | 10   |             |
|  |               | I <sub>H</sub>         |  |        |      |      |             |
| Primary side input current (mA)        | 56,56F,63F,65 | I <sub>in</sub>        |  | -120   |      | 120  |             |
| Input direct current resistance (Ω)    | 56            | R <sub>in</sub>        | Ta=-10°C~+70°C                               | 2.5    | 3.5  | 4.5  |             |
|  | 56F,63F,65    |                        |  | 2.5    | 3.9  | 5.0  |             |
| Input inductance (mH)                  | 56            | L <sub>in</sub>        | Ta=-10°C~+70°C                               | 0.8    | 1.0  | 1.2  | -10°C~+70°C |
|  | 56F,63F,65    |                        |  | 0.8    | 1.1  | 1.4  |             |
| Output voltage (V)                     |               | V <sub>OH</sub>        | R <sub>L</sub> =10kΩ                         | 3.5    |      |      |             |
|  |               | V <sub>OL</sub>        |  |        | 0.1  | 0.8  |             |
| Response (μS)                          |               | ton-off                | R <sub>L</sub> =∞                            |        | 60   |      |             |
| Power supply voltage (V)               |               | V <sub>cc</sub>        |  | +4.5   |      | +5.5 |             |
| Consumption current (mA)               | 56,56F,65     | I <sub>cc</sub>        |  |        | 10   |      |             |
|  | 63F           |                        |  |        | 12   |      |             |
| Effect of external magnetic field (mA) | 56,56F,63F,65 | I <sub>in</sub> offset | I <sub>in</sub> =0<br>B=1×10 <sup>-3</sup> T |        | 3    |      |             |
| "Analog" out put                       | Loss (dB)     | 56,65                  | I <sub>in</sub> =0~120mA<br>1kHz,600Ω        | 30     | 34   | 38   |             |
|  |               | 56F                    |  | 30     | 33   | 36   |             |
|  |               | 63F                    |  | -2     | 0    | 2    |             |
|  | S/N (dB)      | 56,56F,65              |  | 15     |      |      |             |
|  | 63F           |                        |  |        |      |      |             |

**Maximum Rating**

| Item                                  | Marking           | Rating          | Comments             |
|---------------------------------------|-------------------|-----------------|----------------------|
| Power supply voltage (V)              | V <sub>cc</sub>   | 7.0             |                      |
| Primary side input current (A)        | 56,56F,63F,65     | I <sub>in</sub> | 0.5<br>10sec. max.   |
| Withstand voltage between (kVAC) min. |                   | 2.2             | 60sec. 50Hz RH=65±5% |
| Operating temperature range (°C)      | T <sub>opt.</sub> | -10~+70         |                      |
| Storage temperature range (°C)        | T <sub>stg.</sub> | -20~+80         |                      |

**Input Current - Output Voltage Characteristics**

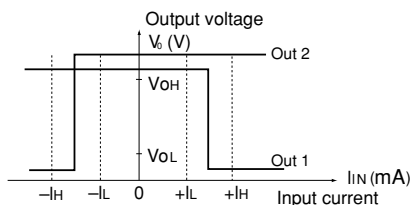

- All specifications in this catalog and production status of products are subject to change without notice. Prior to the purchase, please contact TOKIN for updated product data.
- Please request for a specification sheet for detailed product data prior to the purchase.
- Before using the product in this catalog, please read "Precautions" and other safety precautions listed in the printed version catalog.

## Shape and Dimensions

### ● LA12-10V21 to LA12-24V21

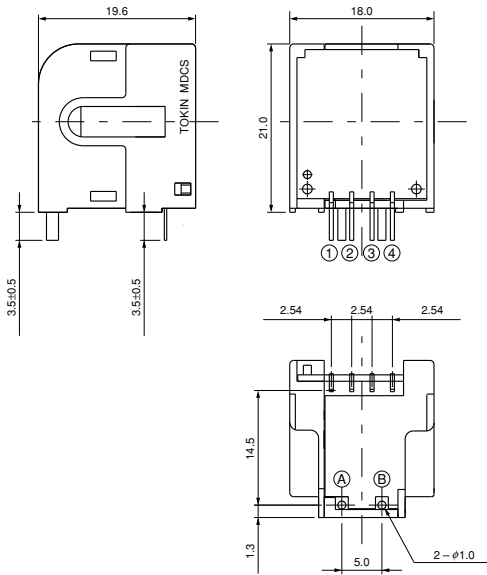

### ● LA12-25V21 to LA12-60V21

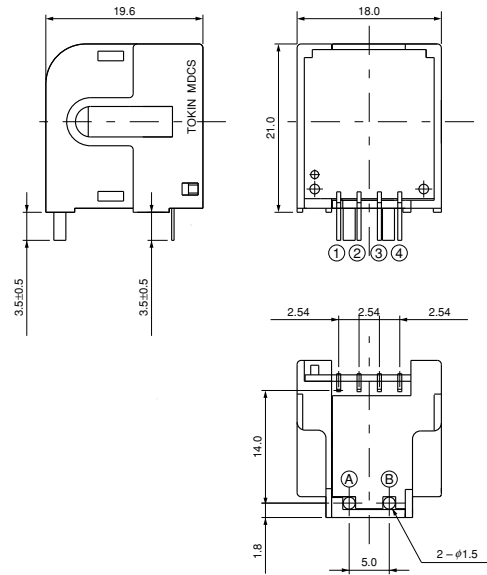

### ● THS-56,56F,65

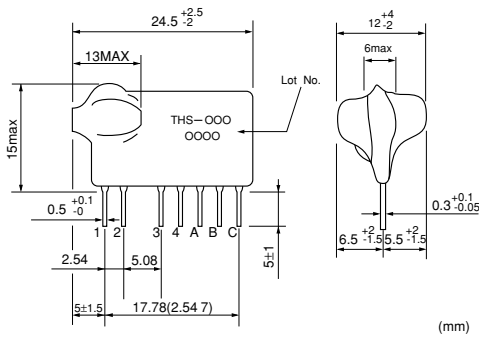

### ● THS-63F

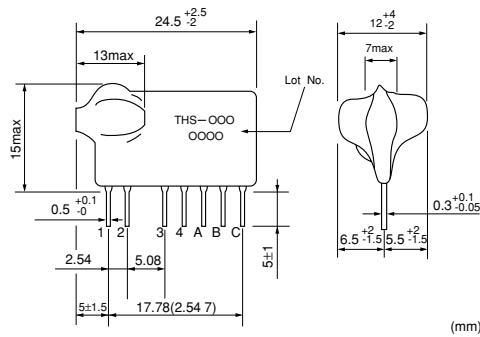

| Pin number | LA12                         | THS56,56F,65,63F    |
|------------|------------------------------|---------------------|
| 1          | NC                           | (Coil input)        |
| 2          | GND<br>(Ground pin)          | (Coil input)        |
| 3          | Vcc<br>(+12V)                | GND<br>(Ground pin) |
| 4          | Vout<br>(Output voltage pin) | "Analog" output     |
| A          | (Measured current<br>⊕pin)   | OUT2                |
| B          | (Measured current<br>⊖pin)   | OUT1                |
| C          | -                            | Vcc<br>(+5V)        |



- All specifications in this catalog and production status of products are subject to change without notice. Prior to the purchase, please contact TOKIN for updated product data.
- Please request for a specification sheet for detailed product data prior to the purchase.
- Before using the product in this catalog, please read "Precautions" and other safety precautions listed in the printed version catalog.

**Before Using Magnetic Direct Current Sensor MDCS™**

- Strong physical shocks could damage cores. Be careful not to drop or apply other strong impact.
- These products are heat resistant up to 260°C for 10 seconds. Be careful not to exceed this amount when soldering. Use a low-corrosion type flux when soldering.
- Because the circuit uses ICs, application of strong static electricity could cause damage. Take static electricity precautions when handling.
- Because these products are magnetic current detectors, application of strong external magnetic fields could cause their characteristics to change. Limit ambient magnetic fields to 50e or less.



- All specifications in this catalog and production status of products are subject to change without notice. Prior to the purchase, please contact TOKIN for updated product data.
- Please request for a specification sheet for detailed product data prior to the purchase.
- Before using the product in this catalog, please read "Precautions" and other safety precautions listed in the printed version catalog.

# Magnetic Type Proximity Switches TMRS™ Series

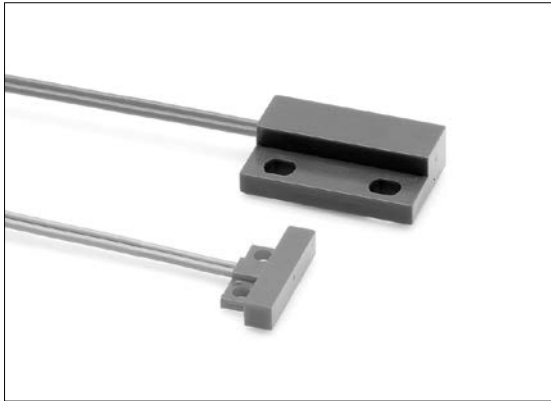

**Outline**

TOKIN's highly reliable magnetic non-contact switches are the result of combining reed switches and magnets, made possible by the contact technology, magnetic circuit technology and plastic molding technology developed through the production of 300 million temperature switches (TMRS™ Series).

**Applications**

- Position detection (air cylinders, automatic doors, etc.)
- Rotation detection

**Features**

- Sealed resin-molded structure makes for easy handling and mechanical strength.
- The contacts are encased in glass for excellent resistance to dust and corrosion.

**Operation Characteristics**

- Normally open type

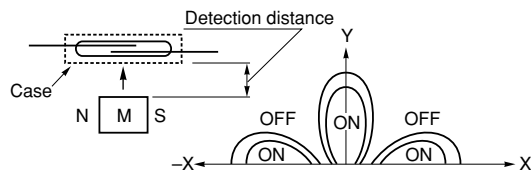

When drive magnet M approaches, the reed switch contacts close and the circuit comes on.

**Specifications**

|             | Product name | Features             | Electrical characteristics  | Life time                                  |
|-------------|--------------|----------------------|---|--|
| TMRS Series | TMRS-3020    | Compact wire harness | Maximum switching voltage 110V AC/DC<br>Maximum switching current 0.5A AC/DC<br>Maximum switching power 10W AC/DC | DC 12V<br>5mA (R)<br>10 <sup>7</sup> times |
|             | TMRS-4001    | General wire harness |   |  |



● All specifications in this catalog and production status of products are subject to change without notice. Prior to the purchase, please contact TOKIN for updated product data.  
● Please request for a specification sheet for detailed product data prior to the purchase.  
● Before using the product in this catalog, please read "Precautions" and other safety precautions listed in the printed version catalog.



**Markings**

● Switch

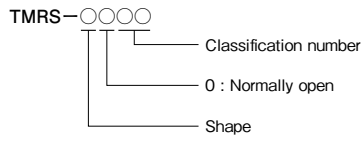

**Shape and Dimensions**

● TMRS-3020

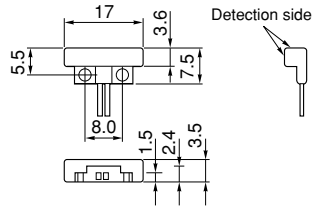

● TMRS-4001

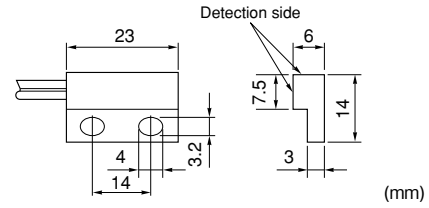

- All specifications in this catalog and production status of products are subject to change without notice. Prior to the purchase, please contact TOKIN for updated product data.
- Please request for a specification sheet for detailed product data prior to the purchase.
- Before using the product in this catalog, please read "Precautions" and other safety precautions listed in the printed version catalog.

**Before Using Proximity Switch Series**

**Fixing the Proximity Switch**

When fixing a proximity switch, avoid warping as shown in Figure 1 caused by rise of filler or an obstacle left on the mounting surface. Also, do not pull a reed wire.

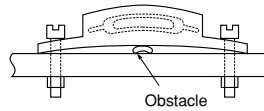

Figure 1 Warping caused by an obstacle left between the proximity switch and the mounting surface.

**Cautions for Shock**

- (1) As the characteristics of the proximity switch (especially sensitive) may deteriorate when the switch falls from above 30cm height, caution must be taken.
- (2) If many proximity switches are mounted on a large print board, caution must be taken when cutting the print board along the perforated line, because the shock of cutting may change the sensitivity of the switch.  
(Along with an effort such as leaving the least part to reduce the shock, we recommend that you confirm that the sensitivity has not changed before use.)

**Contact Protection Circuit**

For improving the reliability of the proximity switch, insert one of the following contact protection circuits when using the switch at a load which causes a surge current.

• Inductive load

If an inductance (coil, electromagnetic relay, motor, etc.) is used as a load, hundred of volts of counter electromotive force (the energy stored in the inductance) will occur to shorten the lifetime of the contact (for the resistance load, that is also true when an inductance is used at a high voltage or a large current). For protection circuits, refer to Figure 2.

**Protection circuit with CR**

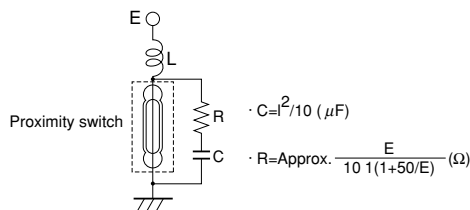

**Protection circuit with varistor**

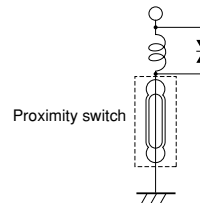

**Protection circuit with diode**

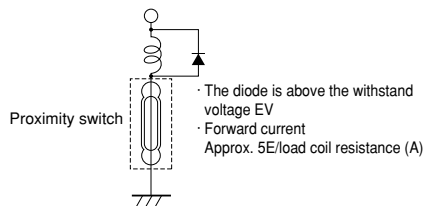

Figure 2



• Capacity load

If a condenser is used as a load, charge/discharge at the capacitance will cause a rush current when the switch is closed, which may make switch opening impossible. In this case, as shown in Figure 3, the method in which a protection resistance R is inserted can be used.

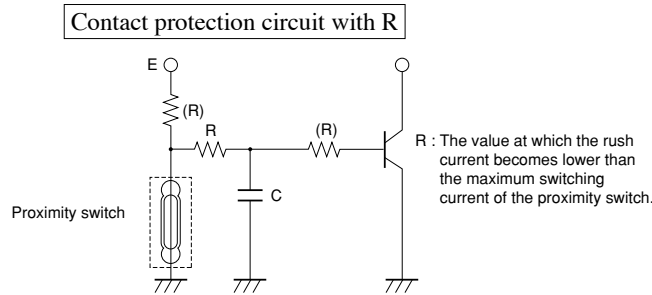

Figure 3

• Lamp load

In general, the filament of the lamp is made of tungsten. With the tungsten filament, the resistance is low when the lamp is turned on and becomes higher as it reaches the stationary current. When this lamp is used with a proximity switch, a rush current (at five to ten times the stationary current) will be caused immediately after lighting, which may result in welding or adhering of the contact. In this case, as shown in Figure 4, a protection resistor R can be inserted.

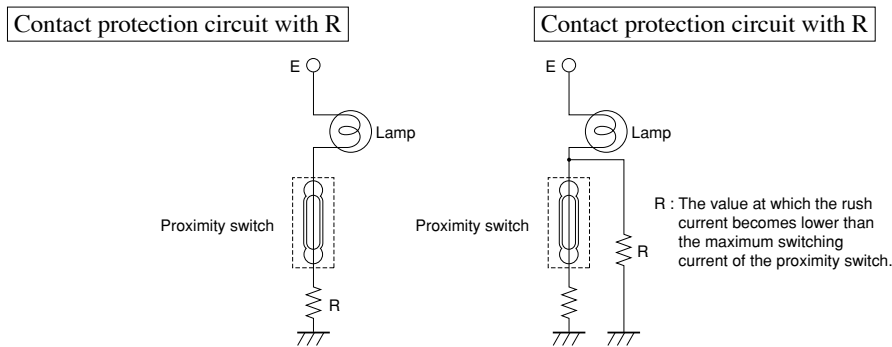

Figure 4

• Wiring capacity load

If a contact and a load are combined by long wires or cable, the floating capacity will cause a rush current when the contact is closed, which largely affects the lifetime of the contact. In this case, as shown in Figure 5, a protection circuit in which a resistance or inductance is added can be used.

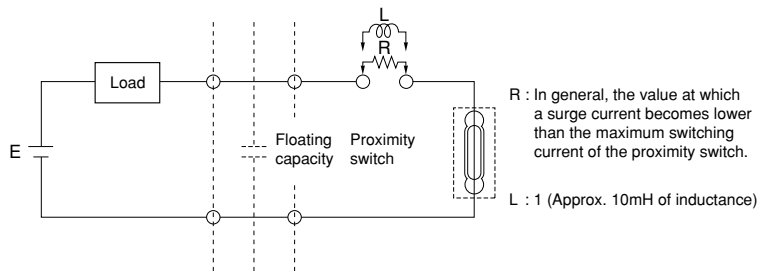

Figure 5



- All specifications in this catalog and production status of products are subject to change without notice. Prior to the purchase, please contact TOKIN for updated product data.
- Please request for a specification sheet for detailed product data prior to the purchase.
- Before using the product in this catalog, please read "Precautions" and other safety precautions listed in the printed version catalog.

**Cautions for Ultrasonic**

- **Ultrasonic cleaning**  
After mounting a proximity switch on a printed circuit board or the like, avoid ultrasonic cleaning because ultrasonic cleaning may change the sensitivity of the switch or crack the seal of the glass tube.
- **Ultrasonic welding**  
Also, avoid ultrasonic welding because, by the same reason as ultrasonic cleaning, the performance of the proximity switch may deteriorate.



- All specifications in this catalog and production status of products are subject to change without notice. Prior to the purchase, please contact TOKIN for updated product data.
- Please request for a specification sheet for detailed product data prior to the purchase.
- Before using the product in this catalog, please read "Precautions" and other safety precautions listed in the printed version catalog.

● For inquiry, please call Product Management Department(JAPAN)

| Products  | Section   | Phone / Fax                                | Adress   |
|---|---|--|--|
| Thermal Reed Switch (TRS™)                                      | For inquiry, Please call<br>Product Management<br>Department(JAPAN) | Phone:81-3-3515-9275<br>Fax:81-3-3515-9276 | Chiyoda First Bldg., 8-1 Nishi-Kanda<br>3-chome, Chiyoda-ku,<br>Tokyo 101-8362,Japan |
| TRS Series Approved by UL, CSA, and VDE                         |   |  |  |
| Thermal Guard (OHD™)  |   |  |  |
| Current Transformer (low current type)                          |   |  |  |
| Zero-Phase Current Transformer ZCT                              |   |  |  |
| Magnetic Direct Current Sensor MDCS™                            |   |  |  |
| Twin Reed Switch Type Safing Sensor High Stand Type:TMSD™-H*51D |   |  |  |
| Ceramic Gyro  |   |  |  |
| Magnetic type Proximity Switches TMRS™ Series                   |   |  |  |
| Proximity Switches NRS Series                                   |   |  |  |
| Surface Mounting Type Reed Switches Case Type:NRS-700 Series    |   |  |  |



- All specifications in this catalog and production status of products are subject to change without notice. Prior to the purchase, please contact TOKIN for updated product data.
- Please request for a specification sheet for detailed product data prior to the purchase.
- Before using the product in this catalog, please read "Precautions" and other safety precautions listed in the printed version catalog.



- All specifications in this catalog and production status of products are subject to change without notice. Prior to the purchase, please contact TOKIN for updated product data.
- Please request for a specification sheet for detailed product data prior to the purchase.
- Before using the product in this catalog, please read "Precautions" and other safety precautions listed in the printed version catalog.

## Precautions



- The names of the products and the specifications in this catalog are subject to change without notice for the sake of improvement. The manufacturer also reserves the right to discontinue any of these products. At the time of delivery, please ask for specifications sheets to check the contents in order to use the products properly and safely.
- Descriptions in this catalog regarding product characteristics and quality are based solely on discrete components. When using these components, be sure to check the specifications with the component in question mounted on the products.
- Each sensor in this catalog may malfunction or break down in a particular mode. When designing products, be sure to include a countermeasure for this eventuality.
- The manufacturer's warranty will not cover any disadvantage or damage caused by improper use of the products that deviates from the characteristics, specifications, or conditions for use described in this catalog.
- The products in this catalog are intended for use in ordinary electronic products. If any of these products are to be used in special applications requiring extremely high reliability, such as in aviation equipment and nuclear power controllers where product defects might pose a safety risk, please consult your TOKIN sales representatives.
- Though the manufacturer has taken all possible precautions to ensure the quality and reliability of its products, improper use of products may result in bodily injury, fire, or similar accident. If you have any questions regarding the use of the products in question, please consult your TOKIN sales representatives.
- Please be advised that the manufacturer accepts no responsibility for any infraction by users of the manufacturer's products on third party patents or industrial copyrights. The manufacturer is responsible only when such infractions are attributable to the structural design of the product and its manufacturing process.
- Export Control
  - For customers outside Japan  
TOKIN products should not be used or sold for use in the development, production, stockpiling or utilization of any conventional weapons or mass-destructive weapons (nuclear weapons, chemical or biological weapons, or missiles), or any other weapons.
  - For customers in Japan  
For products which are controlled items subject to the 'Foreign Exchange and Foreign Trade Law' of Japan, the export license specified by the law is required for export.
- This catalog is current as of March 2015.



- All specifications in this catalog and production status of products are subject to change without notice. Prior to the purchase, please contact TOKIN for updated product data.
- Please request for a specification sheet for detailed product data prior to the purchase.
- Before using the product in this catalog, please read "Precautions" and other safety precautions listed in the printed version catalog.