

## LOS-O-90

~10° x 40° oval beam optimized for Osram Oslon Square EC. 14.3 mm high assembly. Variant with beam direction rotated 90°.

### TECHNICAL SPECIFICATIONS:

Dimensions	Ø 21.6 mm
Height	14.3 mm
Fastening	glue, pin
Colour	white
Box size	480 x 280 x 300 mm
Box weight	9.1 kg
Quantity in Box	1680 pcs
ROHS compliant	yes ⓘ



### MATERIAL SPECIFICATIONS:

Component	Type	Material	Colour
LXP2-O-90	Lens	PMMA	clear
LEILA-HLD-OSL	Holder	PC	white

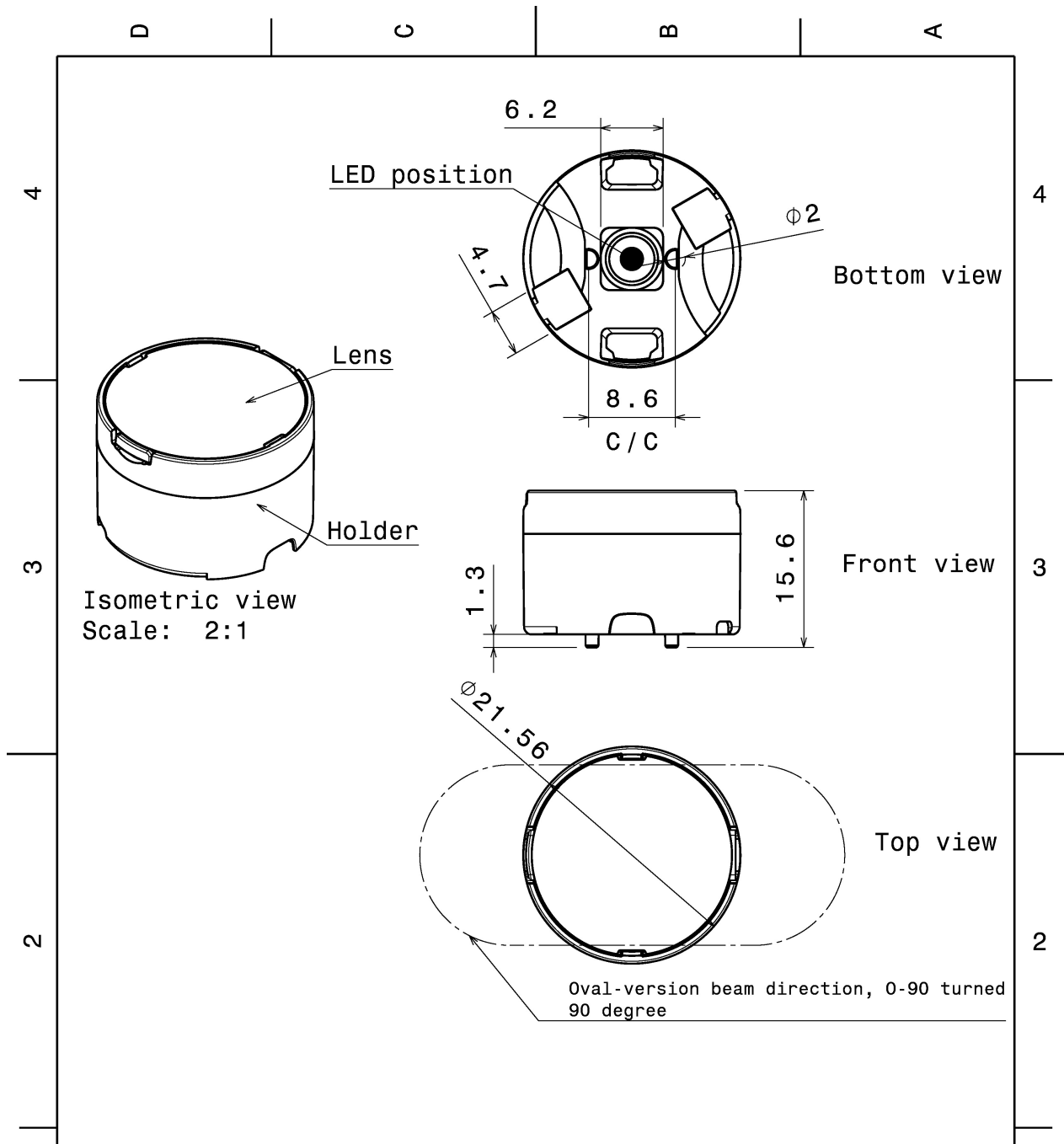

Tolerances if not otherwise shown According to DIN ISO 2768-1 Linear measures: Up to 30mm class M, otherwise class C. According to DIN ISO 2768-2 Form and position: class L				Ledil Oy Salorankatu 10 FIN 24240 SALO Finland	
THIRD ANGLE PROJECTION:		<b>DRAWING TITLE</b> <b>LOS-series assembly</b>			
This drawing is the property of LEDiL Oy. It may not be reproduced, copied or communicated without a written agreement with LEDiL Oy.		<b>SIZE</b> <b>A4</b>		<b>PART NUMBER</b> -	
		<b>SCALE</b> 2:1	<b>WEIGHT</b> -	<b>SHEET</b> 1/1	

#### PHOTOMETRIC DATA (MEASURED):



LED NF2x757A  
FWHM 14.0 + 39.0°  
Efficiency 94 %  
Peak intensity 4.700 cd/lm  
Required components:

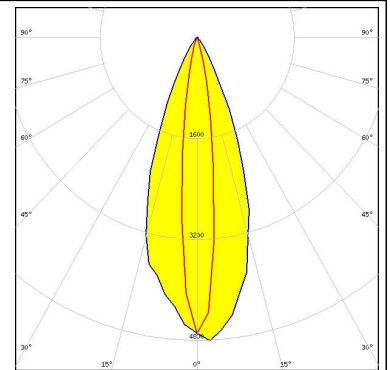

LED Duris S5 (2 chip)  
FWHM 14.0 + 42.0°  
Efficiency 91 %  
Peak intensity 4.500 cd/lm  
Required components:

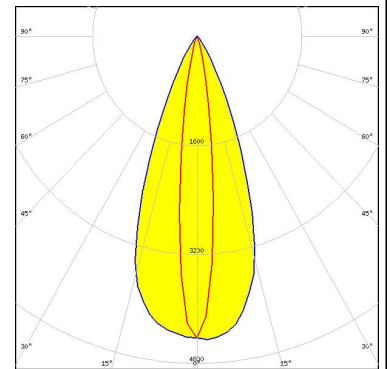
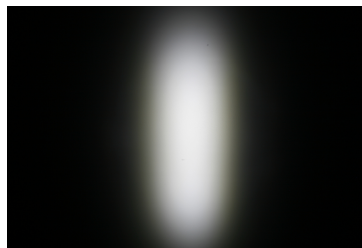

#### PHOTOMETRIC DATA (SIMULATED):

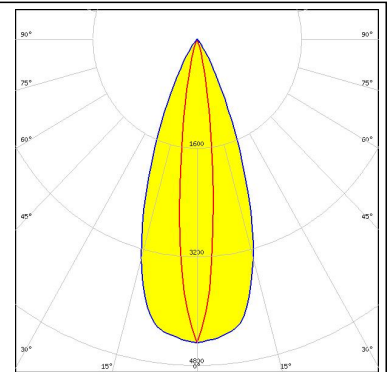
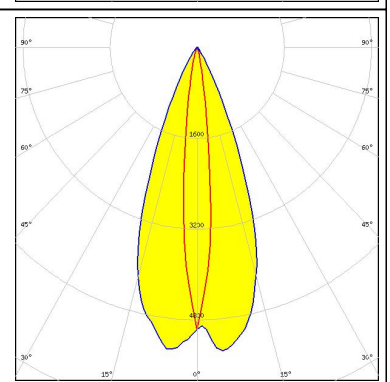
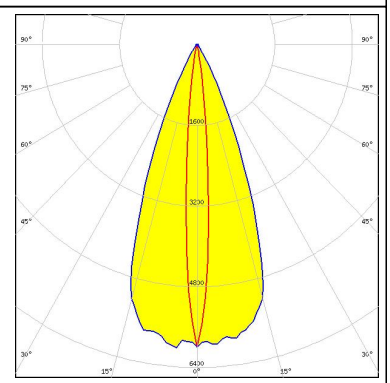
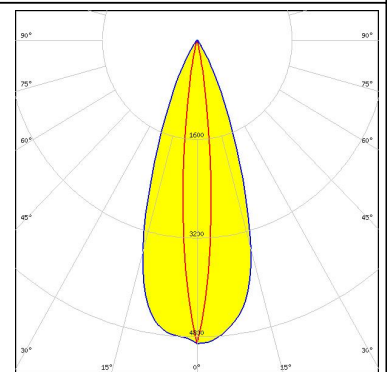
<p><b>NICHIA</b></p> <p>LED NF2x757G            FWHM 13.0 + 40.0°            Efficiency 91 %            Peak intensity 4.500 cd/lm            Required components:</p>	
<p><b>OSRAM</b>  <small>Opto Semiconductors</small></p> <p>LED Oslon Square EC            FWHM 11.0 + 41.0°            Efficiency 94 %            Peak intensity 5.400 cd/lm            Required components:</p>	
<p><b>OSRAM</b>  <small>Opto Semiconductors</small></p> <p>LED Oslon SSL 150            FWHM 9.0 + 42.0°            Efficiency %            Peak intensity 6.000 cd/lm            Required components:</p>	
<p><b>OSRAM</b>  <small>Opto Semiconductors</small></p> <p>LED Oslon SSL 80            FWHM 11.0 + 38.0°            Efficiency %            Peak intensity 4.900 cd/lm            Required components:</p>	

### GENERAL INFORMATION:

NOTE: The typical beam angle will be changed by different color, chip size and chip position tolerance. The typical total beam angle is the full angle measured where the luminous intensity is half of the peak value.

### MATERIALS:

As part of our continuous research and improvement processes, and to ensure the best possible quality and availability of our products, LEDiL reserves the right to change material grades without notice.

### PRODUCT DATA USER AGREEMENT AND DISCLAIMER:

The measured data in the provided downloadable LEDiL Product Datasheets and Mechanical 2D-Drawings is rounded and provided as reference for planning. LEDiL Oy's optical specifications have been verified by conducting performance testing of the products in accordance with the company's quality system. The reported data are averaged results of multiple measurements with typical variation. LEDiL Oy reserves the right to without prior notification make changes and improvements to its products.

LEDiL Oy assumes neither warranty, nor guarantee nor any other liability of any kind for the contents and correctness of the provided data. The provided data has been generated with highest diligence but the provided data may in reality not represent the complete possible variation range of all intrinsic parameters. Therefore, in certain cases a deviation from the provided data could occur.

LEDiL Oy reserves the right to undertake technical changes of its products without further notification which could lead to changes in the provided data. LEDiL Oy assumes no liability of any kind for the possible deviation from any provided data or any other damage resulting from the usage of the provided data.

The user agrees to this disclaimer and user agreement with the download or usage of the provided files.

#### LEDiL Oy

Joensuunkatu 13  
FI-24240 SALO  
Finland

#### LEDiL Inc.

228 West Page Street  
Suite D  
Sycamore IL 60178  
USA

#### Local sales and technical support

[www.ledil.com/  
where\\_to\\_buy](http://www.ledil.com/where_to_buy)

#### Shipping locations

Salo, Finland  
Hong Kong, China

#### Distribution Partners

[www.ledil.com/  
where\\_to\\_buy](http://www.ledil.com/where_to_buy)