

THESE DRAWINGS ARE THE PROPERTY OF QUALTEK ELECTRONICS AND NOT TO BE REPRODUCED FOR OR COMMUNICATED TO A THIRD PARTY WITHOUT THE EXPRESS WRITTEN PERMISSION OF AN OFFICER OF QUALTEK ELECTRONICS.

REVISION			
REV.	DESCRIPTION	DATE	APPROVED
B	RoHS Compliancy	06-01-06	DP

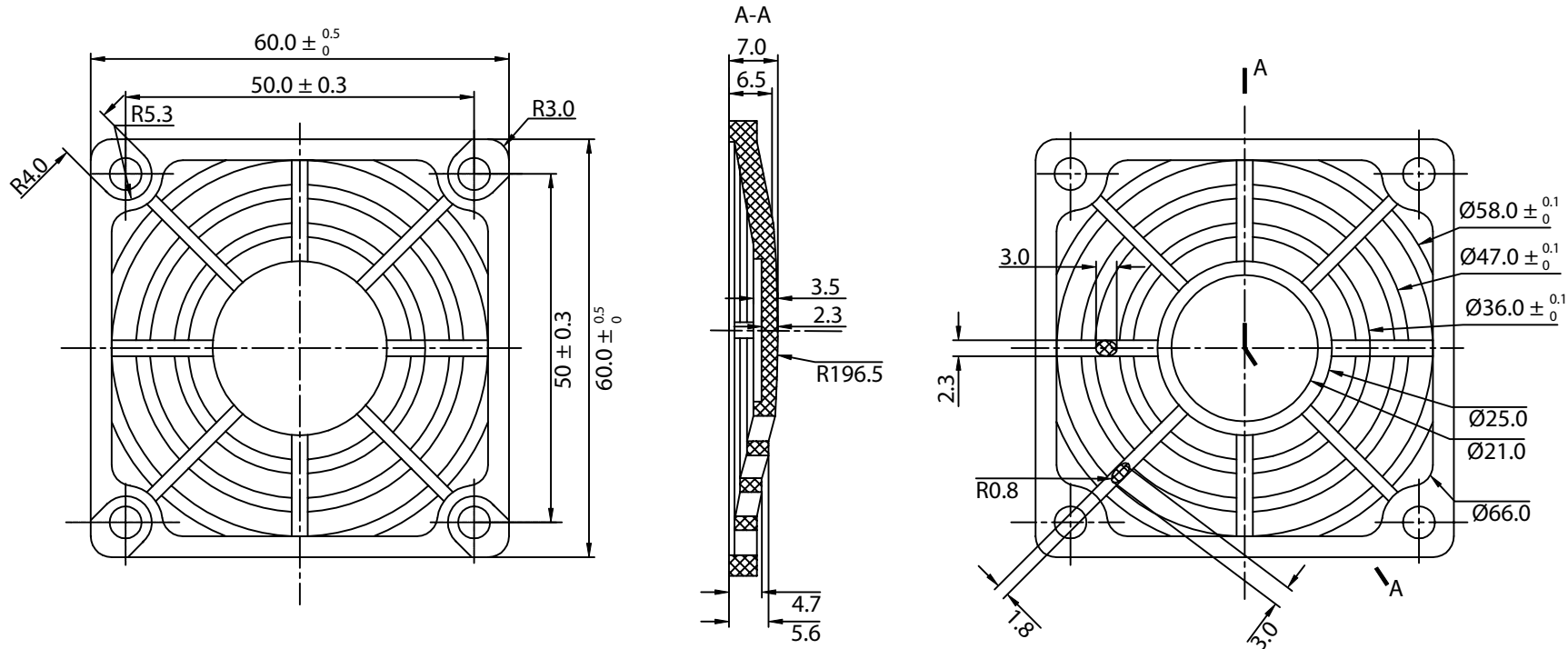

CONTROLLED

NOTES:

MATERIAL: PBT UL94V-0
RoHS COMPLIANT

Dim range (mm)	Tolerance +/- (mm)	Qualtek Electronics Corp. FAN-S DIVISION		
		Part Number:	RoHS Compliant	
0-5	0.1	09252-G		
5-16	0.15	Description:	PLASTIC FAN GUARD	
16-64	0.2		UNIT: mm	REV: B
64-250	0.4	Drawn / Date	Checked / Date	Approved / Date
250-1000	0.5	B. ZHANG 10-17-03	10-17-03	JJH / 10-17-03
1000-1500	1.0			