

Features

- No External Components Except PIN Diode
- Supply-voltage Range: 4.5 V to 5.5 V
- Automatic Sensitivity Adaptation (AGC)
- Automatic Strong Signal Adaptation (ATC)
- Enhanced Immunity Against Ambient Light Disturbances
- Available for Carrier Frequencies between 30 kHz to 76 kHz; Adjusted by Zener Diode Fusing
- TTL and CMOS Compatible
- Suitable Minimum Burst Length ≥ 6 or 10 Pulses/Burst

Applications

- Audio Video Applications
- Home Appliances
- Remote Control Equipment

Description

The IC T2525 is a complete IR receiver for data communication developed and optimized for use in carrier-frequency-modulated transmission applications. Its function can be described using the block diagram (see Figure 1). The input stage meets two main functions. First, it provides a suitable bias voltage for the PIN diode. Secondly, the pulsed photo-current signals are transformed into a voltage by a special circuit which is optimized for low-noise applications. After amplification by a **Controlled Gain Amplifier (CGA)**, the signals have to pass a tuned integrated narrow bandpass filter with a center frequency f_0 which is equivalent to the chosen carrier frequency of the input signal. The demodulator is used to convert the input burst signal into a digital envelope output pulse and to evaluate the signal information quality, i.e., unwanted pulses will be suppressed at the output pin. All this is done by means of an integrated dynamic feedback circuit which varies the gain as a function of the present environmental condition (ambient light, modulated lamps etc.). Other special features are used to adapt to the current application to secure best transmission quality. The T2525 operates in a supply-voltage range of 4.5 V to 5.5 V.

Figure 1. Block Diagram

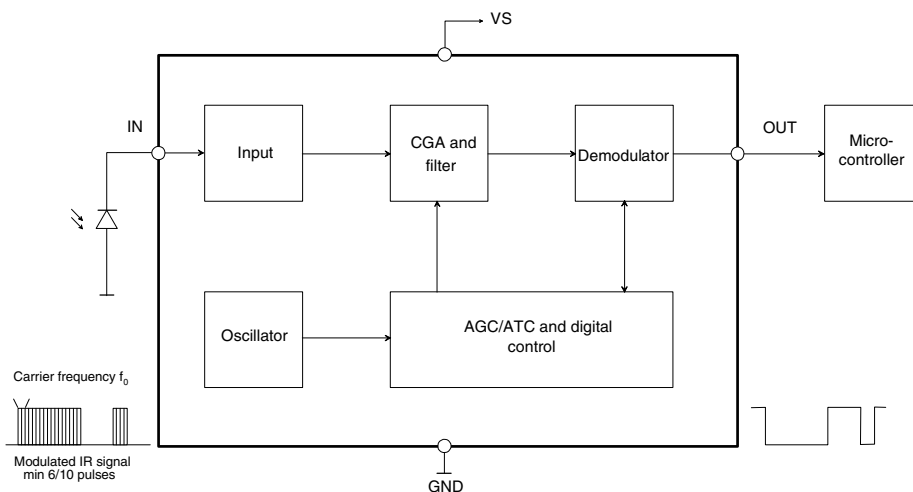

IR Receiver
ASSP

T2525



Pin Configuration

Figure 2. Pinning SO8 and TSSOP8

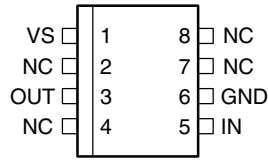

Pin Description

Pin	Symbol	Function
1	VS	Supply voltage
2	NC	Not connected
3	OUT	Data output
4	NC	Not connected
5	IN	Input PIN diode
6	GND	Ground
7	NC	Not connected
8	NC	Not connected

Absolute Maximum Ratings

Stresses beyond those listed under “Absolute Maximum Ratings” may cause permanent damage to the device. This is a stress rating only and functional operation of the device at these or any other conditions beyond those indicated in the operational sections of this specification is not implied. Exposure to absolute maximum rating conditions for extended periods may affect device reliability.

Parameters	Symbol	Value	Unit
Supply voltage	V_S	-0.3 to +6	V
Supply current	I_S	3	mA
Input voltage	V_{IN}	-0.3 to V_S	V
Input DC current at $V_S = 5\text{ V}$	I_{IN}	0.75	mA
Output voltage	V_O	-0.3 to V_S	V
Output current	I_O	10	mA
Operating temperature	T_{amb}	-25 to +85	°C
Storage temperature	T_{stg}	-40 to +125	°C
Power dissipation at $T_{amb} = 25^\circ\text{C}$	P_{tot}	30	mW

Thermal Resistance

Parameter	Symbol	Value	Unit
Junction ambient SO8	R_{thJA}	130	K/W
Junction ambient TSSOP8	R_{thJA}	TBD	K/W

Electrical Characteristics

$T_{amb} = 25^{\circ}\text{C}$, $V_S = 5\text{ V}$ unless otherwise specified.

No.	Parameters	Test Conditions	Pin	Symbol	Min.	Typ.	Max.	Unit	Type*
1	Supply								
1.1	Supply-voltage range		1	V_S	4.5	5	5.5	V	C
1.2	Supply current	$I_{IN} = 0$	1	I_S	0.8	1.1	1.4	mA	B
2	Output								
2.1	Internal pull-up resistor ⁽¹⁾	$T_{amb} = 25^{\circ}\text{C}$; see Figure 9 on page 7	1,3	R_{PU}		30/40		k Ω	A
2.2	Output voltage low	$I_L = 2\text{ mA}$; see Figure 9 on page 7	3,6	V_{OL}			250	mV	B
2.3	Output voltage high		3,1	V_{OH}	$V_S - 0.25$		V_S	V	B
2.4	Output current clamping	$R_2 = 0$; see Figure 9 on page 7	3,6	I_{OCL}		8		mA	B
3	Input								
3.1	Input DC current	$V_{IN} = 0$; see Figure 9 on page 7	5	I_{IN_DCMAX}	-85			μA	C
3.2	Input DC current; Figure 4 on page 5	$V_{IN} = 0$; $V_S = 5\text{ V}$; $T_{amb} = 25^{\circ}\text{C}$	5	I_{IN_DCMAX}	-530	-960		μA	B
3.3	Minimum detection threshold current; Figure 3 on page 5	Test signal: see Figure 8 on page 7 $V_S = 5\text{ V}$, $T_{amb} = 25^{\circ}\text{C}$, $I_{IN_DC} = 1\text{ }\mu\text{A}$; square pp, burst $N = 16$, $f = f_0$; $t_{PER} = 10\text{ ms}$, Figure 8 on page 7; BER = 50 ⁽²⁾	3	I_{Eemin}		-520		μA	B
3.4	Minimum detection threshold current with AC current disturbance $I_{IN_AC100} = 3\text{ }\mu\text{A}$ at 100 Hz	Test signal: see Figure 8 on page 7 $V_S = 5\text{ V}$, $T_{amb} = 25^{\circ}\text{C}$, $I_{IN_DC} = 1\text{ }\mu\text{A}$, square pp, burst $N = 16$, $f = f_0$; $t_{PER} = 10\text{ ms}$, Figure 8 on page 7; BER = 50% ⁽²⁾	3	I_{Eemin}		-800		μA	C

*) Type means: A = 100% tested, B = 100% correlation tested, C = Characterized on samples, D = Design parameter

- Notes:
1. Depending on version, see "Ordering Information"
 2. BER = Bit Error Rate; e.g., BER = 5% means that with $P = 20$ at the input pin 19..21 pulses can appear at the pin OUT
 3. After transformation of input current into voltage

Electrical Characteristics (Continued)

$T_{amb} = 25^{\circ}\text{C}$, $V_S = 5\text{ V}$ unless otherwise specified.

No.	Parameters	Test Conditions	Pin	Symbol	Min.	Typ.	Max.	Unit	Type*
3.5	Maximum detection threshold current with $V_{IN} > 0\text{V}$	Test signal: see Figure 8 on page 7 $V_S = 5\text{ V}$, $T_{amb} = 25^{\circ}\text{C}$, $I_{IN_DC} = 1\ \mu\text{A}$; square pp, burst $N = 16$, $f = f_0$; $t_{PER} = 10\text{ ms}$, Figure 8 on page 7; $\text{BER} = 5\%^{(2)}$	3	I_{Eemax}	-400			μA	D
4	Controlled Amplifier and Filter								
4.1	Maximum value of variable gain (CGA)			G_{VARMAX}		51		dB	D
4.2	Minimum value of variable gain (CGA)			G_{VARMIN}		-5		dB	D
4.3	Total internal amplification ⁽³⁾			G_{MAX}		71		dB	D
4.4	Center frequency fusing accuracy of bandpass	$V_S = 5\text{ V}$, $T_{amb} = 25^{\circ}\text{C}$		f_{0_FUSE}	-3	f_0	+3	%	A
4.5	Overall accuracy center frequency of bandpass			f_0	-6.7	f_0	+4.1	%	C
4.6	BPF bandwidth: type N0 - N3	-3 dB; $f_0 = 38\text{ kHz}$; see Figure 6 on page 6		B		3.5		kHz	C
	BPF bandwidth: type N6, N7	-3 dB; $f_0 = 38\text{ kHz}$ Figure 6 on page 6		B		5.4		kHz	C

*) Type means: A = 100% tested, B = 100% correlation tested, C = Characterized on samples, D = Design parameter

- Notes:
1. Depending on version, see "Ordering Information"
 2. BER = Bit Error Rate; e.g., BER = 5% means that with $P = 20$ at the input pin 19...21 pulses can appear at the pin OUT
 3. After transformation of input current into voltage

ESD All pins \Rightarrow 2000V HBM; 200V MM, MIL-STD-883C, Method 3015.7

Reliability Electrical qualification (1000h) in molded SO8 plastic package

Typical Electrical Curves at $T_{amb} = 25^{\circ}C$

Figure 3. I_{Eemin} versus I_{IN_DC} , $V_S = 5 V$

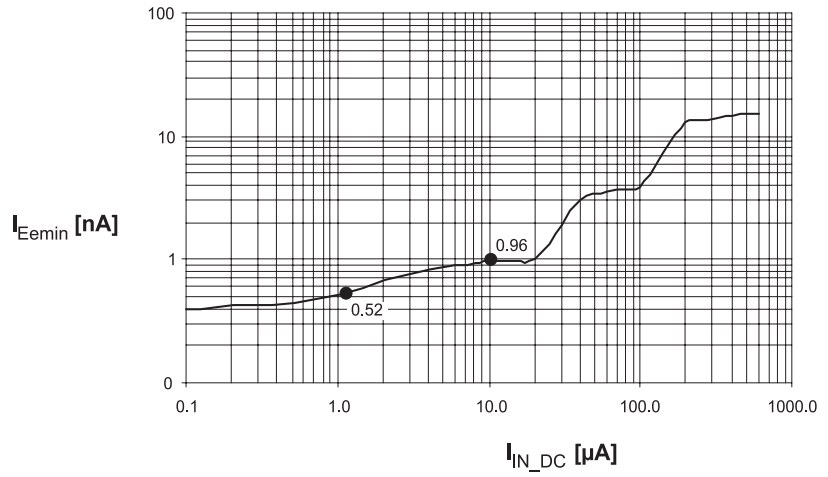

Figure 4. V_{IN} versus I_{IN_DC} , $V_S = 5 V$

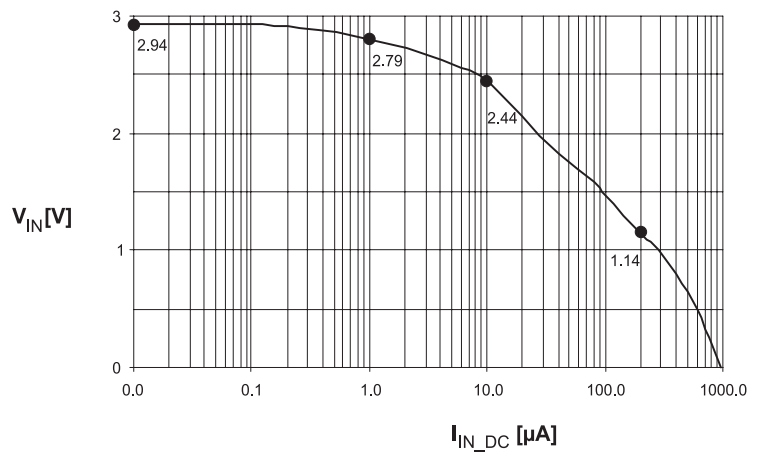

Figure 5. Data Transmission Rate, $V_S = 5 V$

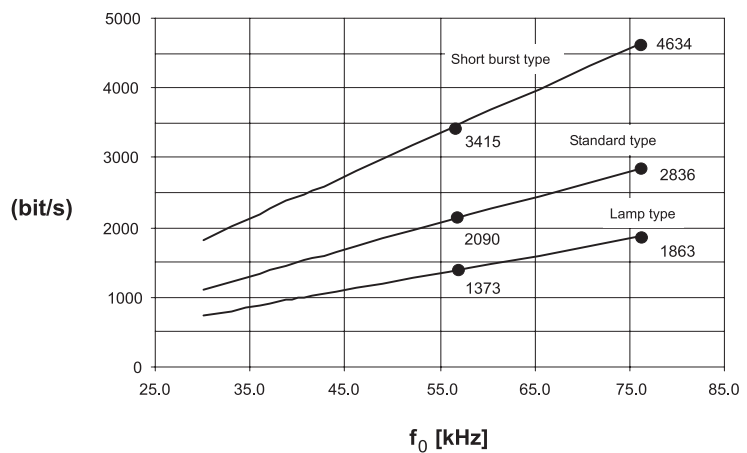
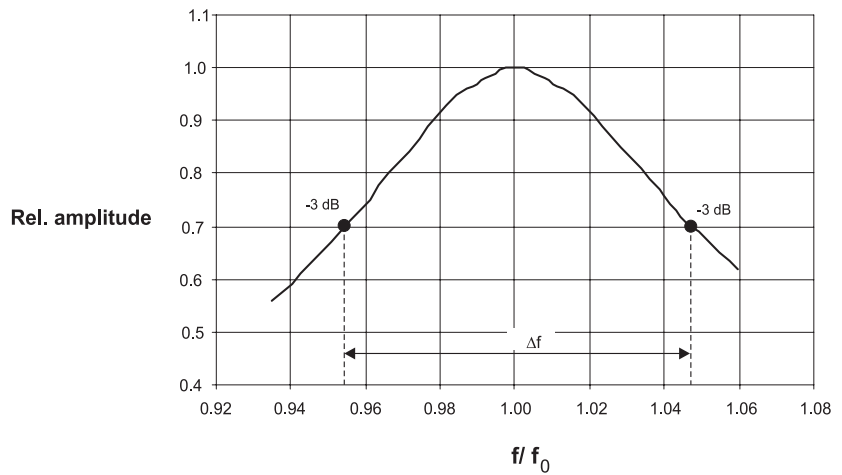
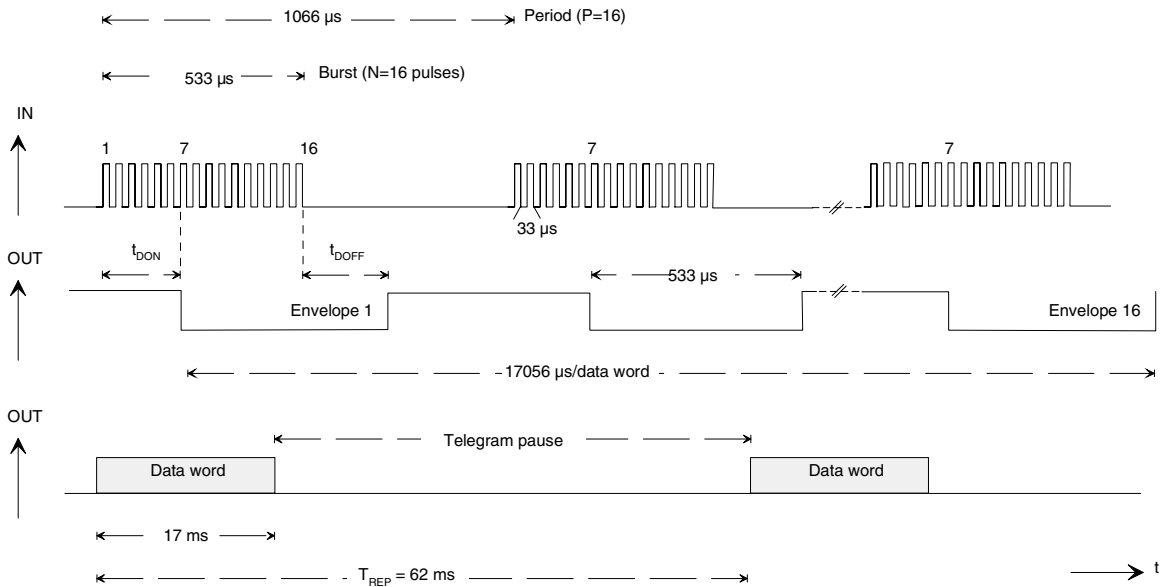

Figure 6. Typical Bandpass Curve



$Q = f_0/\Delta f$; $\Delta f = -3 \text{ dB values}$. Example: $Q = 1/(1.047 - 0.954) = 11$

Figure 7. Illustration of Used Terms



Example: $f = 30 \text{ kHz}$, burst with 16 pulses, 16 periods

Chip Dimensions

Figure 10. Chip Size in μm

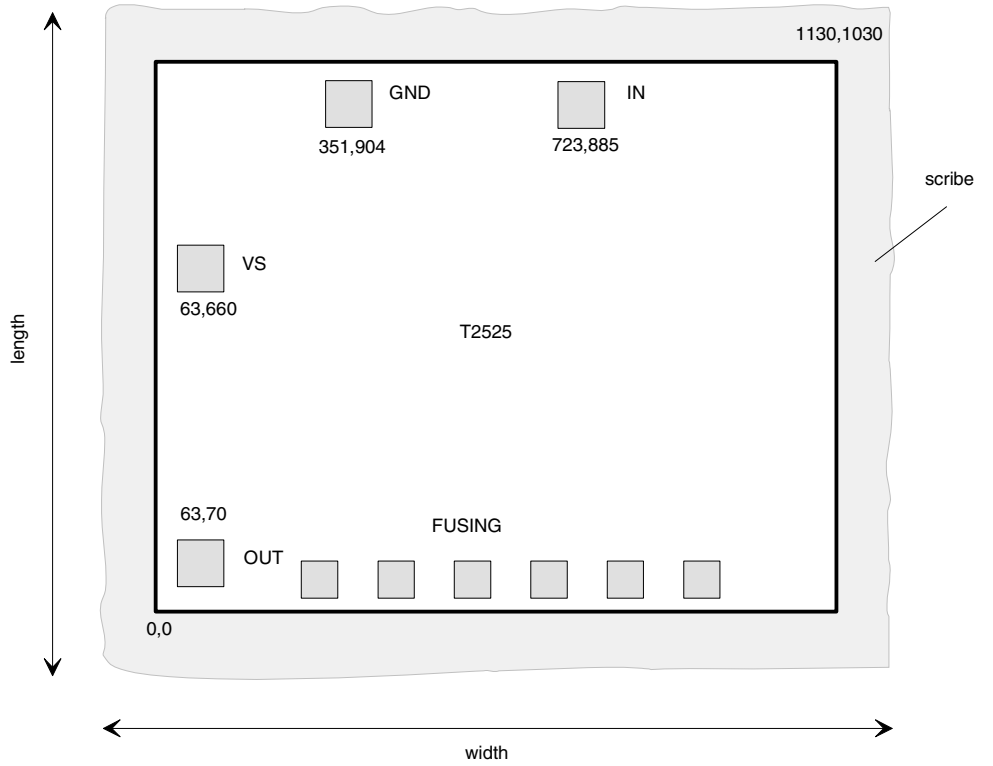

Note: Pad coordinates are for lower left corner of the pad in μm from the origin 0,0

Dimensions	Length inclusive scribe	1.15 mm
	Width inclusive scribe	1.29 mm
	Thickness	$290 \mu \pm 5\%$
	Pads	$90 \mu \times 90 \mu$
	Fusing pads	$70 \mu \times 70 \mu$
Pad metallurgy	Material	$\text{AlCu/AlSiTi}^{(1)}$
	Thickness	$0.8 \mu\text{m}$
Finish	Material	$\text{Si}_3\text{N}_4/\text{SiO}_2$
	Thickness	$0.7/0.3 \mu\text{m}$

Note: 1. Value depends on manufacture location.

Ordering Information

Extended Type Number	PL ⁽²⁾	R _{PU} ⁽³⁾	D ⁽⁴⁾	Type
T2525N0xx ⁽¹⁾ -yyy ⁽⁵⁾	2	30	2090	Standard type: ≥ 10 pulses, enhanced sensibility, high data rate
T2525N1xx ⁽¹⁾ -DDW	1	30	2090	Standard type: ≥ 10 pulses, enhanced sensibility, high data rate
T2525N2xx ⁽¹⁾ -yyy ⁽⁵⁾	2	40	1373	Lamp type: ≥ 10 pulses, enhanced suppression of disturbances, secure data transmission
T2525N3xx ⁽¹⁾ -DDW	1	40	1373	Lamp type: ≥ 10 pulses, enhanced suppression of disturbances, secure data transmission
T2525N6xx ⁽¹⁾ -yyy ⁽⁵⁾	2	30	3415	Short burst type: ≥ 6 pulses, enhanced data rate
T2525N7xx ⁽¹⁾ -DDW	1	30	3415	Short burst type: ≥ 6 pulses, enhanced data rate

- Notes:
- xx means the used carrier frequency value f_0 30,33,36,38,40,44 ,56 kHz.(76 kHz type on request)
 - Two pad layout versions (see Figure 11 and Figure 12) available for different assembly demand
 - Integrated pull-up resistor at pin OUT (see “Electrical Characteristics”)
 - Typical data transmission rate up to bit/s with $f_0 = 56$ kHz, $V_S = 5$ V (see Figure 5 on page 5)
 - yyy means kind of packaging:
DDW -> unsawn wafers in box
6AQ -> (only on request, TSSOP8 taped and reeled)

Pad Layout

Figure 11. Pad Layout 1 (DDW only)

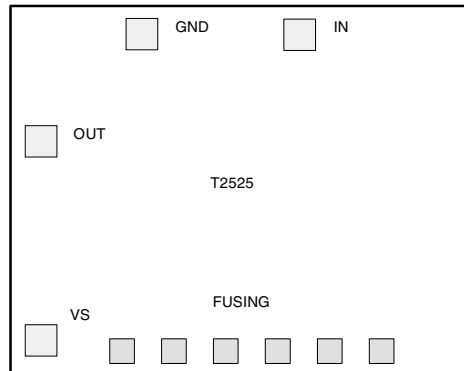
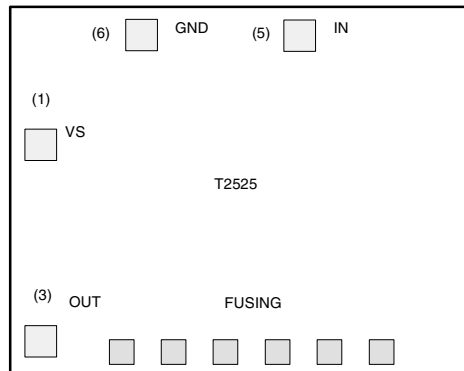

Figure 12. Pad Layout 2 (DDW, SO8 or TSSOP8)





Atmel Corporation

2325 Orchard Parkway
San Jose, CA 95131, USA
Tel: 1(408) 441-0311
Fax: 1(408) 487-2600

Regional Headquarters

Europe

Atmel Sarl
Route des Arsenalux 41
Case Postale 80
CH-1705 Fribourg
Switzerland
Tel: (41) 26-426-5555
Fax: (41) 26-426-5500

Asia

Room 1219
Chinachem Golden Plaza
77 Mody Road Tsimshatsui
East Kowloon
Hong Kong
Tel: (852) 2721-9778
Fax: (852) 2722-1369

Japan

9F, Tonetsu Shinkawa Bldg.
1-24-8 Shinkawa
Chuo-ku, Tokyo 104-0033
Japan
Tel: (81) 3-3523-3551
Fax: (81) 3-3523-7581

Atmel Operations

Memory

2325 Orchard Parkway
San Jose, CA 95131, USA
Tel: 1(408) 441-0311
Fax: 1(408) 436-4314

Microcontrollers

2325 Orchard Parkway
San Jose, CA 95131, USA
Tel: 1(408) 441-0311
Fax: 1(408) 436-4314

La Chantrerie
BP 70602
44306 Nantes Cedex 3, France
Tel: (33) 2-40-18-18-18
Fax: (33) 2-40-18-19-60

ASIC/ASSP/Smart Cards

Zone Industrielle
13106 Rousset Cedex, France
Tel: (33) 4-42-53-60-00
Fax: (33) 4-42-53-60-01

1150 East Cheyenne Mtn. Blvd.
Colorado Springs, CO 80906, USA
Tel: 1(719) 576-3300
Fax: 1(719) 540-1759

Scottish Enterprise Technology Park
Maxwell Building
East Kilbride G75 0QR, Scotland
Tel: (44) 1355-803-000
Fax: (44) 1355-242-743

RF/Automotive

Theresienstrasse 2
Postfach 3535
74025 Heilbronn, Germany
Tel: (49) 71-31-67-0
Fax: (49) 71-31-67-2340

1150 East Cheyenne Mtn. Blvd.
Colorado Springs, CO 80906, USA
Tel: 1(719) 576-3300
Fax: 1(719) 540-1759

Biometrics/Imaging/Hi-Rel MPU/ High Speed Converters/RF Datacom

Avenue de Rochepleine
BP 123
38521 Saint-Egreve Cedex, France
Tel: (33) 4-76-58-30-00
Fax: (33) 4-76-58-34-80

Literature Requests

www.atmel.com/literature

Disclaimer: Atmel Corporation makes no warranty for the use of its products, other than those expressly contained in the Company's standard warranty which is detailed in Atmel's Terms and Conditions located on the Company's web site. The Company assumes no responsibility for any errors which may appear in this document, reserves the right to change devices or specifications detailed herein at any time without notice, and does not make any commitment to update the information contained herein. No licenses to patents or other intellectual property of Atmel are granted by the Company in connection with the sale of Atmel products, expressly or by implication. Atmel's products are not authorized for use as critical components in life support devices or systems.

© Atmel Corporation 2003. All rights reserved.

Atmel® and combinations thereof are the registered trademarks of Atmel Corporation or its subsidiaries.

Other terms and product names may be the trademarks of others.



Printed on recycled paper.

4657D-AUTO-11/03