FCC RF Test Report

Product Name : GSM/GPRS Wireless Data Module

Model No. : SIM800H

FCC ID : UDV-2013072401

Applicant : Shanghai Simcom Ltd.

Address : Building A,SIM Technology Building,No.633

Jinzhong Road,Changning District,Shanghai

R.R.China

Date of Receipt : 30/07/2013

Test Date : 20/07/2013~30/07/2013

Issued Date : 30/07/2013

Report No. : UL15820130723FCC24-3

Report Version : V1.0

The test results relate only to the samples tested.

The test results shown in the test report are traceable to the national/international standard through the calibration of the equipment and evaluated measurement uncertainty herein.

This report must not be used to claim product endorsement by TAF, CNAS or any agency of the Government. The test report shall not be reproduced except in full without the written approval of Unilab Corporation.

Test Report Certification

Issued Date : 30/07/2013

Report No. : UL15820130723FCC24-3

Product Name : GSM/GPRS Wireless Data Module
Applicant : Shanghai Simcom Ltd.
Address : Building A,SIM Technology Building,No.633,Jinzhong Road, Changning District,Shanghai R.R.China
Manufacturer : Shanghai Simcom Ltd.
Address : Building A,SIM Technology Building,No.633,Jinzhong Road, Changning District,Shanghai R.R.China
Model No. : SIM800H
EUT Voltage : MIN: 3.6V, NOR: 3.8V, MAX: 4.2V
Brand Name : SIMCom
Applicable Standard : ANSI/TIA-603-D-2010
FCC CFR Title 47 Part 2
FCC CFR Title 47 Part 22 Subpart H
FCC CFR Title 47 Part24 Subpart E
Test Result : Complied
Performed Location : Unilab (Shanghai) Co.,Ltd.
FCC 2.948 register number is 714465
No.1350, Lianxi Road, Pudong New District, Shangha,China
TEL:+86-21-5027-5125/FAX:+86-21-5027-5126-876

Documented By :



(Technical Engineer: Andy Wei)

Reviewed By :



(Senior Engineer: Forest Cao)

Approved By :



(Supervisor: Eva Wang)

TABLE OF CONTENTS

Description	Page
SUMMARY OF TEST RESULT	5
1. General Information.....	6
1.1. EUT Description.....	6
1.2. Mode of Operation.....	6
1.3. Tested System Details.....	7
1.4. Configuration of Tested System.....	7
1.5. EUT Exercise Software.....	8
1.6. Test Environment.....	9
2. Peak Output Power	10
2.1. Test Equipment.....	10
2.2. Test Setup.....	10
2.3. Limit.....	11
2.4. Test Procedure.....	12
2.5. Uncertainty.....	12
2.6. Test Result.....	13
2.7. Test Photograph.....	16
3. Modulation Characteristic.....	18
3.1. Test Equipment.....	18
3.2. Test Setup.....	18
3.3. Limit.....	19
3.4. Test Procedure.....	19
3.5. Uncertainty.....	19
3.6. Test Result.....	20
3.7. Test Photograph.....	21
4. Occupied Bandwidth.....	22
4.1. Test Equipment.....	22
4.2. Test Setup.....	22
4.3. Limit.....	22
4.4. Test Procedure.....	23
4.5. Uncertainty.....	23
4.6. Test Result.....	24
4.7. Test Photograph.....	32
5. Spurious Emission At Antenna Terminals (+/- 1MHz).....	33
5.1. Test Equipment.....	33
5.2. Test Setup.....	33
5.3. Limit.....	34
5.4. Test Procedure.....	34
5.5. Uncertainty.....	34

5.6. Test Result.....	35
5.7. Test Photograph.....	39
6. Spurious Emission.....	40
6.1. Test Equipment.....	40
6.2. Test Setup.....	41
6.3. Limit.....	42
6.4. Test Procedure.....	42
6.5. Uncertainty.....	43
6.6. Test Result.....	44
6.7. Test Photograph.....	56
7. Frequency Stability Under Temperature & Voltage Variations.....	58
7.1. Test Equipment.....	58
7.2. Test Setup.....	58
7.3. Limit.....	59
7.4. Test Procedure.....	59
7.5. Uncertainty.....	59
7.6. Test Result.....	60
7.7. Test Photograph.....	63
8. Attachment.....	63
EUT Photograph.....	63

SUMMARY OF TEST RESULT

Report Section	FCC Rule	Description	Limit	Result	Remark
3	§2.1046	Conducted Output Power	N/A	PASS	-
3	§22.913(a)(2)	Effective Radiated Power	<7 Watts	PASS	-
3	§24.232(c)	Equivalent Isotropic Radiated Power	<2 Watts	PASS	-
4	§2.1046	Modulation Characteristic	N/A	PASS	
5	§2.1049 §22.917(a) §24.238(a)	Occupied Bandwidth	N/A	PASS	-
6	§2.1051 §22.917(a) §24.238(a)	Band Edge Measurement	<43+10lg(P[Watts])	PASS	-
7	§2.1051 §22.917(a) §24.238(a)	Conducted Emission	<43+10lg(P[Watts])	PASS	-
7	§2.1053 §22.917(a) §24.238(a)	Field Strength of Spurious Radiation	<43+10lg(P[Watts])	PASS	-
8	§2.1055 §22.355 §24.235	Frequency Stability for Temperature & Voltage	<2.5 ppm	PASS	-

1.General Information

1.1. EUT Description

Product Name:	GSM/GPRS Wireless Data Module
Model Name:	SIM800H
Hardware Version:	V1.02
Software Version:	SIM800 R13.08
RF Exposure Environment:	Uncontrolled
GSM/ GPRS	
Support Band:	GSM850/ GSM1900
Tx Frequency Range:	GSM 850: 824MHz ~849MHz GSM 1900: 1850MHz ~1910MHz
Rx Frequency Range:	GSM 850: 869MHz ~894MHz GSM 1900: 1930MHz ~1990MHz
Type of modulation:	GMSK
Antenna Type:	external
Antenna Peak Gain:	3 (dBi)
AC Adapter:	Model Name: JHC-A01-1A0
	Input: AC 100-240V 50/60Hz
	Output: DC 5V/1A

1.2. Mode of Operation

Unilab has verified the construction and function in typical operation. All the test modes were carried out with the EUT in normal operation, which was shown in this test report and defined as:

Test Mode		
Band	Radiated TCs	Conducted TCs
GSM 850 GPRS 850	GSM Link GPRS 8 Link	GSM Link GPRS 8 Link
GSM1900 GPRS 1900	GSM Link GPRS 8 Link	GSM Link GPRS 8 Link

Note:

1. Regards to the frequency band operation: the lowest, middle and highest frequency of channel were selected to perform the test, then shown on this report.
2. The maximum power levels are GSM and GPRS multi-slot class 8 mode for GMSK link.
3. For the ERP/EIRP and radiated emission test, every axis (X, Y, Z) was verified, and show the worst (Z axis) result on this report.
4. This device is a composite device in accordance with Part 15 Subpart B regulations. The report number is UL15820130723FCC24-3

The conducted power table is as follows:

Conducted Power (Unit: dBm)						
Band	GSM850			GSM1900		
Channel	128	189	251	512	661	810
Frequency	824.2	836.4	848.8	1850.2	1880	1909.8
GSM	32.24	32.28	32.33	29.30	29.23	29.28
GPRS 8	32.33	32.32	32.31	29.52	29.52	29.57
GPRS 10	31.12	31.10	31.12	27.87	27.88	27.87
GPRS 12	29.01	29.02	29.02	25.56	25.45	25.52

1.3. Tested System Details

The types for all equipments, plus descriptions of all cables used in the tested system (including inserted cards) are:

Product	Manufacturer	Model	Serial No.	Power Cord
1 Agilent8960	Agilent	E5515C	GB46581718	N/A

1.4. Configuration of Tested System

Connection Diagram

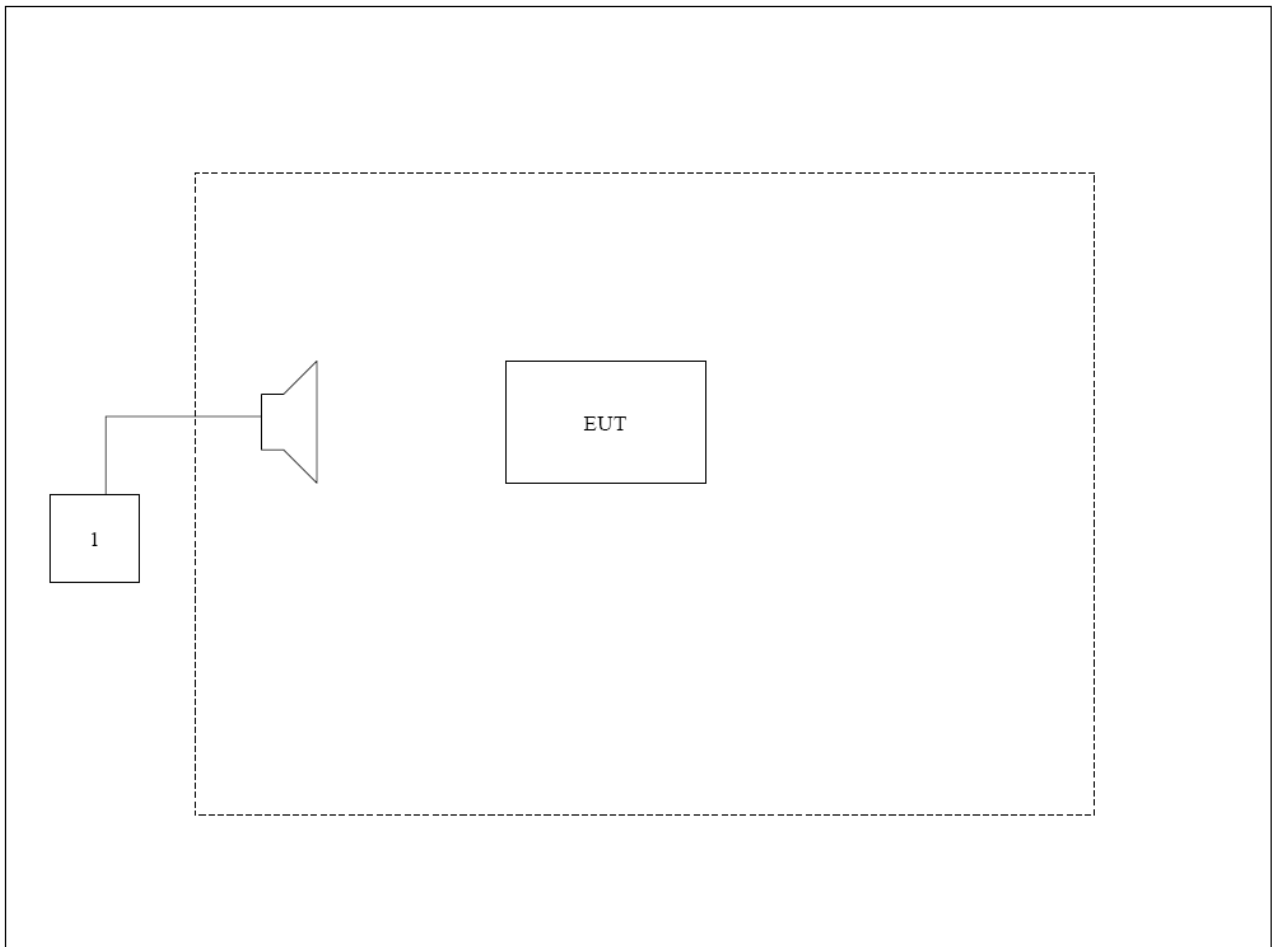

1.5. EUT Exercise Software

1	Setup the EUT and simulators as shown on above.
2	Turn on the power of all equipment.
3	EUT Communicate with E5515C, then select channel to test.

1.6. Test Environment

Items	Required (IEC 68-1)	Actual
Temperature (°C)	15-35	23
Humidity (%RH)	25-75	52
Barometric pressure (mbar)	860-1060	950-1000

2. Peak Output Power

2.1. Test Equipment

Instrument	Manufacturer	Model	Serial No.	Cali. Due Date
Spectrum Analyzer	Agilent	N9038A	MY51210142	2013.09.27
Radio Communication Tester	Agilent	E5515C	GB46581718	2013.10.25
Signal Generator	Agilent	N5183A	MY50140938	2013.10.08
Preamplifier	CEM	EM30180	3008A0245	2014.03.01
DC Power Supply	Agilent	6612C	MY43002989	2014.03.04
Bilog Antenna	Schwarzbeck	VULB9160	9160-3316	2013.09.19
VHF-UHF-Biconical Antenna	Schwarzbeck	VUBA9117	9117-263	2013.09.19
Broad-Band Horn Antenna	Schwarzbeck	BBHA9120D	9120D-942	2013.09.19
Broad-Band Horn Antenna	Schwarzbeck	BBHA9120D	9120D-943	2013.09.19

2.2. Test Setup

Conducted Power Measurement:

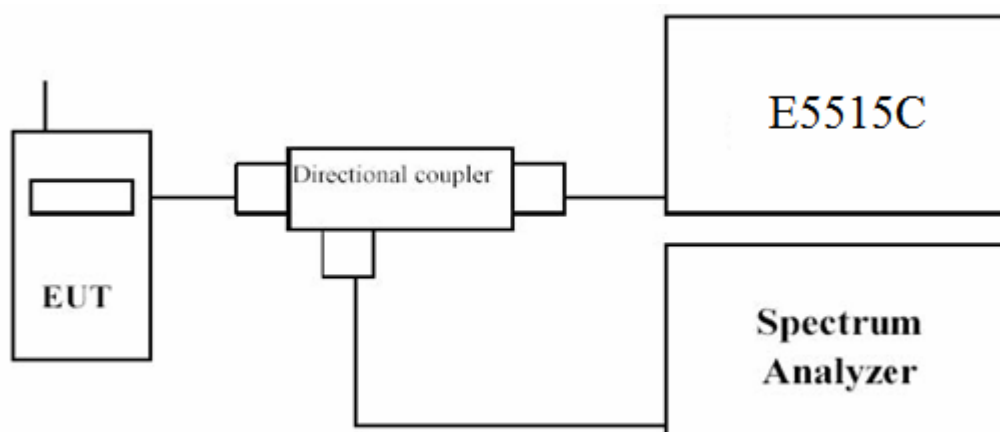

Radiated Power Measurement: below 1GHz

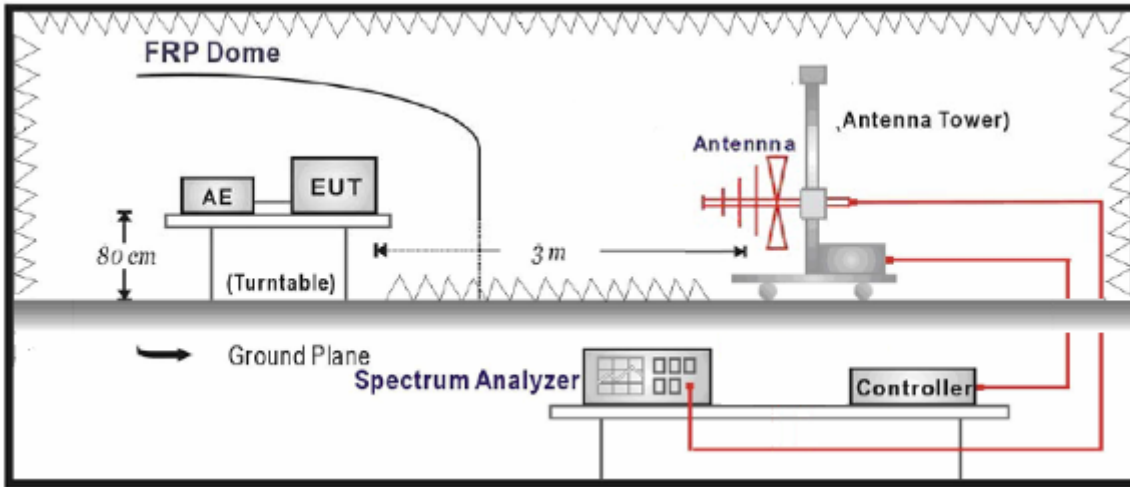

Radiated Power Measurement: above 1GHz

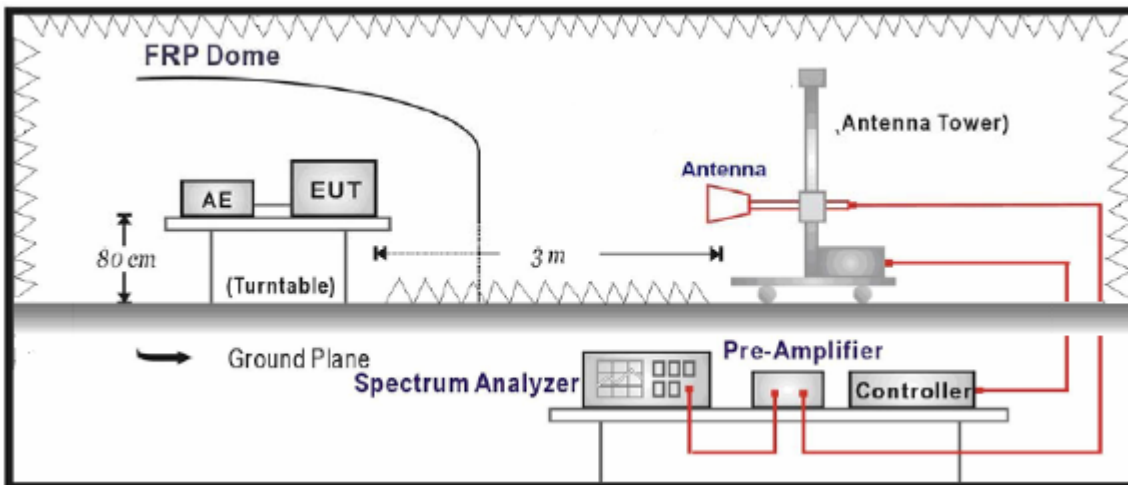

2.3. Limit

For FCC Part 22.913(a)(2):

The ERP of mobile transmitters and auxiliary test transmitters must not exceed 7 Watts.

For FCC Part 24.232(c):

The EIRP of mobile transmitters and auxiliary test transmitters must not exceed 2 Watts.

2.4. Test Procedure

Conducted Power Measurement:

- a. Place the EUT on a bench and set it in transmitting mode.
- b. Connect a low loss RF cable from the antenna port to a spectrum analyzer and E5515C by a Directional Couple.
- c. EUT Communicate with E5515C, then selects a channel for testing.
- d. Add a correction factor to the display of spectrum, and then test.

Radiated Power Measurement:

- a. The EUT shall be placed at the specified height on a support, and in the position closest to normal use as declared by provider.
- b. The test antenna shall be oriented initially for vertical polarization and shall be chosen to correspond to the frequency of the transmitter
- c. The output of the test antenna shall be connected to the measuring receiver.
- d. The transmitter shall be switched on and the measuring receiver shall be tuned to the frequency of the transmitter under test.
- e. The test antenna shall be raised and lowered through the specified range of height until a maximum signal level is detected by the measuring receiver.
- f. The transmitter shall then be rotated through 360° in the horizontal plane, until the maximum signal level is detected by the measuring receiver.
- g. The test antenna shall be raised and lowered again through the specified range of height until a maximum signal level is detected by the measuring receiver.
- h. The maximum signal level detected by the measuring receiver shall be noted.
- i. The transmitter shall be replaced by a substitution antenna.
- j. The substitution antenna shall be orientated for vertical polarization and the length of the substitution antenna shall be adjusted to correspond to the frequency of the transmitter.
- k. The substitution antenna shall be connected to a calibrated signal generator.
- l. If necessary, the input attenuator setting of the measuring receiver shall be adjusted in order to increase the sensitivity of the measuring receiver.
- m. The test antenna shall be raised and lowered through the specified range of height to ensure that the maximum signal is received.
- n. The input signal to the substitution antenna shall be adjusted to the level that produces a level detected by the measuring receiver, that is equal to the level noted while the transmitter radiated power was measured, corrected for the change of input attenuator setting of the measuring receiver.
- o. The measurement shall be repeated with the test antenna and the substitution antenna orientated for horizontal polarization.
- p. The measure of the effective radiated power is the larger of the two levels recorded at the input to the substitution antenna, corrected for gain of the substitution antenna if necessary.
- q. Test site anechoic chamber refer to ANSI C63.4: 2009.

2.5. Uncertainty

The measurement uncertainty is defined as for Conducted Power Measurement ± 1.1 dB, for Radiated Power Measurement ± 3.1 dB

2.6. Test Result

The following table shows the Conducted Output Power

Table 1

Cellular Band				
Modes	Channel	Frequency (MHz)	Conducted Power (dBm)	Conducted Power (Watts)
GSM850	128(Low)	824.2	32.24	1.67
	189(Mid)	836.4	32.28	1.69
	251(High)	848.8	32.33	1.71
GPRS 850	128(Low)	824.2	32.33	1.71
	189(Mid)	836.4	32.32	1.70
	251(High)	848.8	32.31	1.70

Table 2

PCS Band				
Modes	Channel	Frequency (MHz)	Conducted Power (dBm)	Conducted Power (Watts)
GSM1900	512(Low)	1850.2	29.30	0.85
	661(Mid)	1880.0	29.23	0.83
	810(High)	1909.8	29.28	0.84
GPRS 1900	512(Low)	1850.2	29.52	0.89
	661(Mid)	1880.0	29.52	0.89
	810(High)	1909.8	29.57	0.90

The following table shows the Radiated power measured :

GSM850(GSM)

Frequency (MHz)	Ant. Pol. (H/V)	SG Reading (dBm)	Cable Loss (dB)	Gain (dBd)	ERP (dBm)	ERP (W)
Low Channel 128 (824.20MHz)						
824.2	H	36.2	3.53	-3.29	29.38	0.86
824.2	V	30.85	3.53	-3.29	24.03	0.25
Middle Channel 189 (836.40MHz)						
836.4	H	32.71	3.46	-3.14	26.11	0.40
836.4	V	31.18	3.46	-3.14	24.58	0.28
High Channel 251 (848.80MHz)						
848.8	H	37.34	3.84	-3.10	30.40	1.09
848.8	V	33.48	3.84	-3.10	26.54	0.45

GPRS 850

Frequency (MHz)	Ant. Pol. (H/V)	SG Reading (dBm)	Cable Loss (dB)	Gain (dBd)	ERP (dBm)	ERP (W)
Low Channel 128 (824.20MHz)						
824.2	H	34.95	3.53	-3.29	28.13	0.65
824.2	V	31.64	3.53	-3.29	24.82	0.30
Middle Channel 189 (836.40MHz)						
836.4	H	34.1	3.46	-3.14	27.50	0.56
836.4	V	31.82	3.46	-3.14	25.22	0.33
High Channel 251 (848.80MHz)						
848.8	H	37.64	3.84	-3.10	30.7	1.17
848.8	V	33.34	3.84	-3.10	26.4	0.43

GSM1900 (GSM)

Frequency (MHz)	Ant. Pol. (H/V)	SG Reading (dBm)	Cable Loss (dB)	Gain (dBi)	EIRP (dBm)	EIRP (W)
Low Channel 512(1850.20MHz)						
1850.2	H	21.19	5.89	10.42	25.72	0.37
1850.2	V	25.09	5.89	10.42	29.62	0.90
Middle Channel 661 (1880.00MHz)						
1880.0	H	17.43	6.04	10.14	21.53	0.14
1880.0	V	24.65	6.04	10.14	28.75	0.74
High Channel 810 (1909.80MHz)						
1909.8	H	17.51	6.24	10.11	21.38	0.13
1909.8	V	20.5	6.24	10.11	24.37	0.27

GPRS 1900

Frequency (MHz)	Ant. Pol. (H/V)	SG Reading (dBm)	Cable Loss (dB)	Gain (dBi)	EIRP (dBm)	EIRP (W)
Low Channel 512(1850.20MHz)						
1850.2	H	20.29	5.89	10.42	24.82	0.30
1850.2	V	24.24	5.89	10.42	28.77	0.75
Middle Channel 661 (1880.00MHz)						
1880.0	H	18.57	6.04	10.14	22.67	0.18
1880.0	V	24.05	6.04	10.14	28.15	0.65
High Channel 810 (1909.80MHz)						
1909.8	H	19.43	6.24	10.11	23.30	0.21
1909.8	V	22.37	6.24	10.11	26.24	0.42

2.7. Test Photograph

Description: ERP Test Setup



Description: EIRP Test Setup



Description: Conducted Power Measurement Test Setup

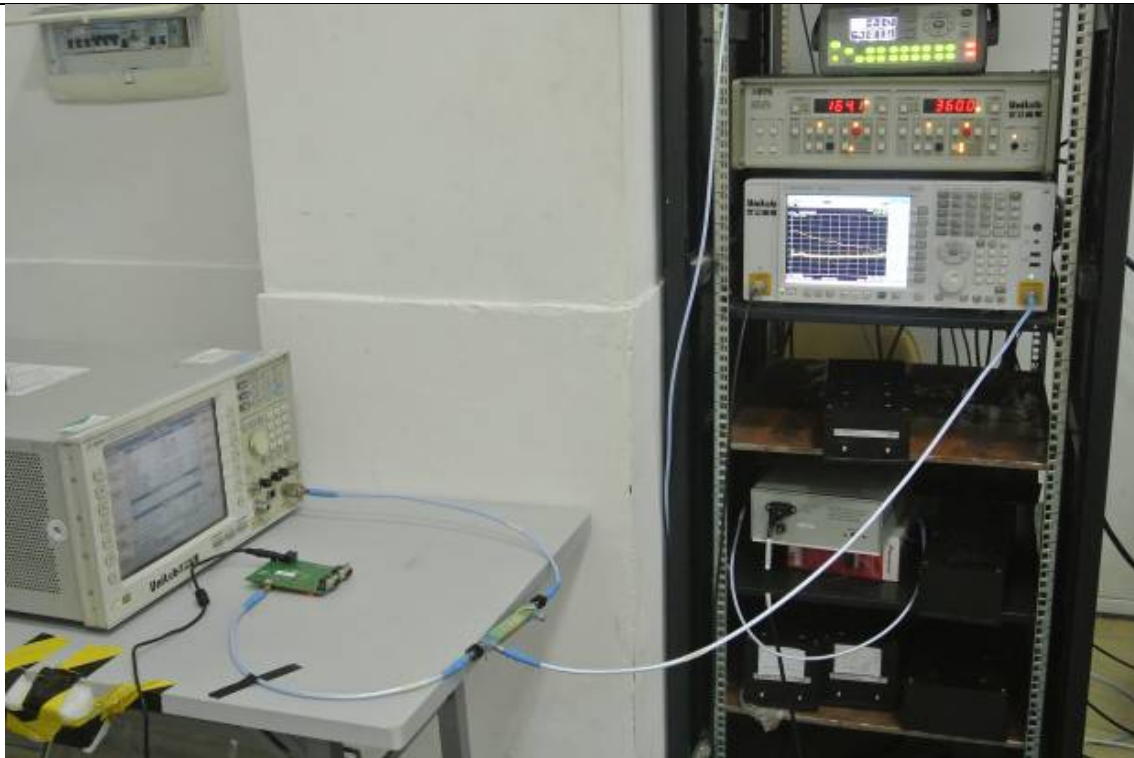

3. Modulation Characteristic

3.1. Test Equipment

Modulation Characteristic / AC-6

Instrument	Manufacturer	Model	Serial No	Cal. Date
Radio Communication Tester	Agilent	E5515C	GB46581718	2013.10.25
DC Power Supply	Agilent	6612C	MY43002989	2014.03.04

3.2. Test Setup

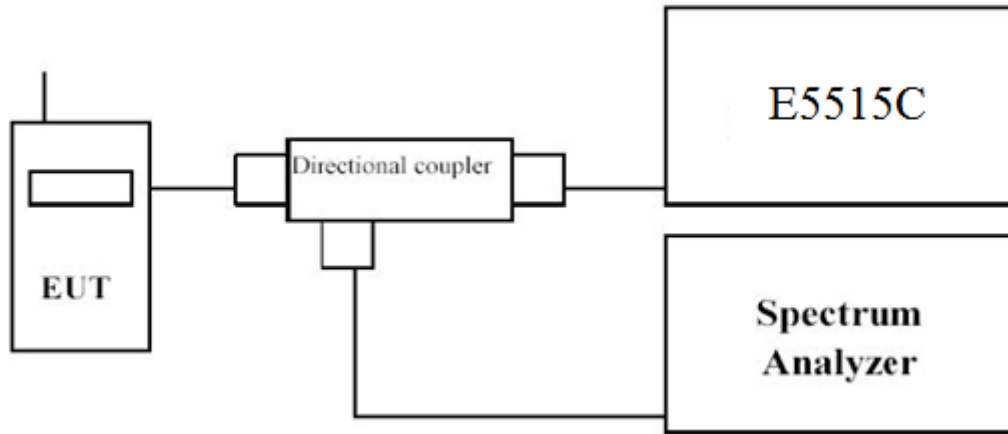

3.3. Limit

N/A

3.4. Test Procedure

GMSK is a form of binary signaling schemes which represent digital states as a shift between discrete sinusoidal frequencies called Frequency Shift Keying (FSK). Minimum Shift Keying (MSK) is continuous phase FSK with the smallest possible modulation index h . Modulation index is defined as:
 $h = 2 \cdot F \cdot T_b$

where F = Peak frequency deviation in Hz and T_b = Bit period in seconds

Two discrete frequencies, representing two distinct digital states, with equal phases at switch time $t = 0$ requires a minimum value of $h = 0.5$. The Gaussian part of GMSK describes the fact that the digital pulses are filtered in the time domain. This results in bits which are sinusoidal rather than square. The effective spectrum is then compressed with the average carrier frequency in the center of the passband. This is a great advantage because of the significantly reduced bandwidth. GMSK is utilized because of these bandwidth conservation properties.

The bandwidth for GSM is a 60 MHz up-link at 1850-1910 MHz and down-link at 1930-1990 MHz. The 65 MHz is divided into 299 channels, each of which is 200 kHz wide. Slight spectral spillage is allowed into neighboring channels (which is minimized by GMSK). This separated transmit/receive frequencies scheme under GSM enables easier duplex filtering.

Within the bandwidth, individual channels are subdivided into multiframes (made of 26 frames), frames (made of 8 time slots), and time slots (made of 8 fields). The time slots are 0.57 ms long allowing 156.25 bits of information including overhead.

The modulation used in GPRS is the same used in GSM. A GSM channel contains eight timeslots, each timeslot is dedicated to one circuit switched call. For GPRS the timeslots are assigned on an as needed basis, and more than one timeslot can be assigned for a particular transmission depending on the network and the device.

3.5. Uncertainty

The measurement uncertainty is defined as 0.1%

3.6. Test Result

The modulation of GSM(850/1900)/GPRS(850/1900) was verified and confirmed compliance with requirement.

3.7. Test Photograph

Description: Modulation Characteristic Test Setup

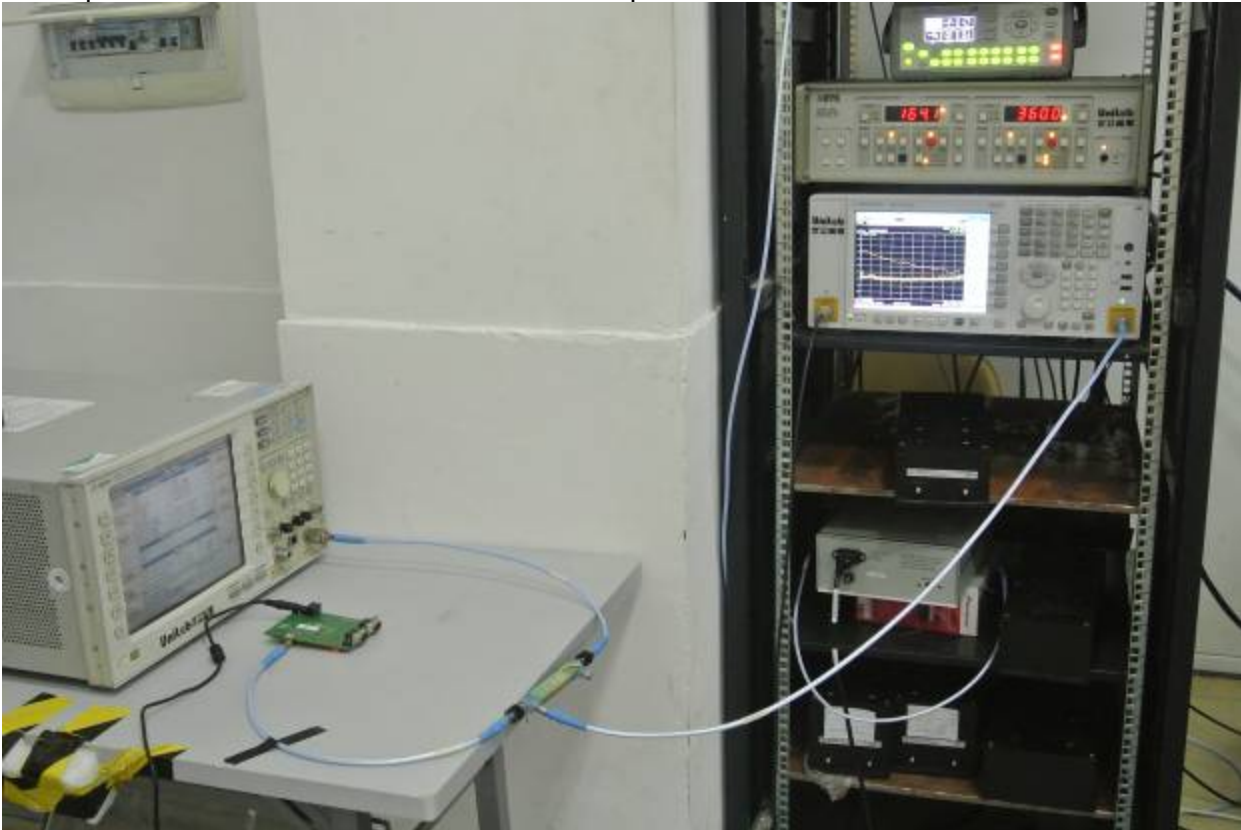

4. Occupied Bandwidth

4.1. Test Equipment

Occupied Bandwidth

Instrument	Manufacturer	Model	Serial No	Cal. Date
Radio Communication Tester	Agilent	E5515C	GB46581718	2013.10.25
Spectrum Analyzer	Agilent	N9038A	MY51210142	2013.09.27
DC Power Supply	Agilent	6612C	MY43002989	2014.03.04

4.2. Test Setup

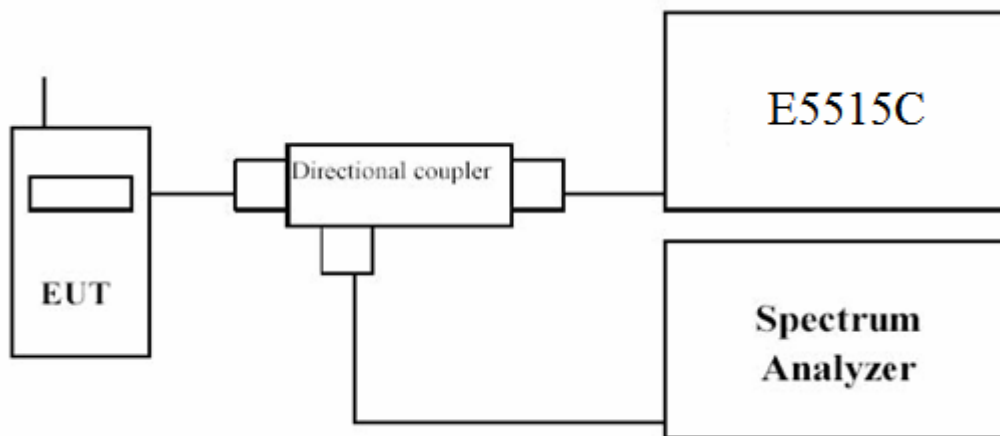

4.3. Limit

N/A

4.4. Test Procedure

Using Occupied Bandwidth measurement function of spectrum analyzer, and setting as follows:
For GPRS 850/1900 test --- RBW = 3 kHz and VBW = 10 kHz

4.5. Uncertainty

The measurement uncertainty is defined as ± 10 Hz

4.6. Test Result

GSM850

Channel No.	Frequency (MHz)	-26dB Occupied Bandwidth (kHz)	99% Occupied Bandwidth (kHz)
128	824.20	346	281
189	836.40	341	280
251	848.80	349	287

GSM850 (Channel 128)

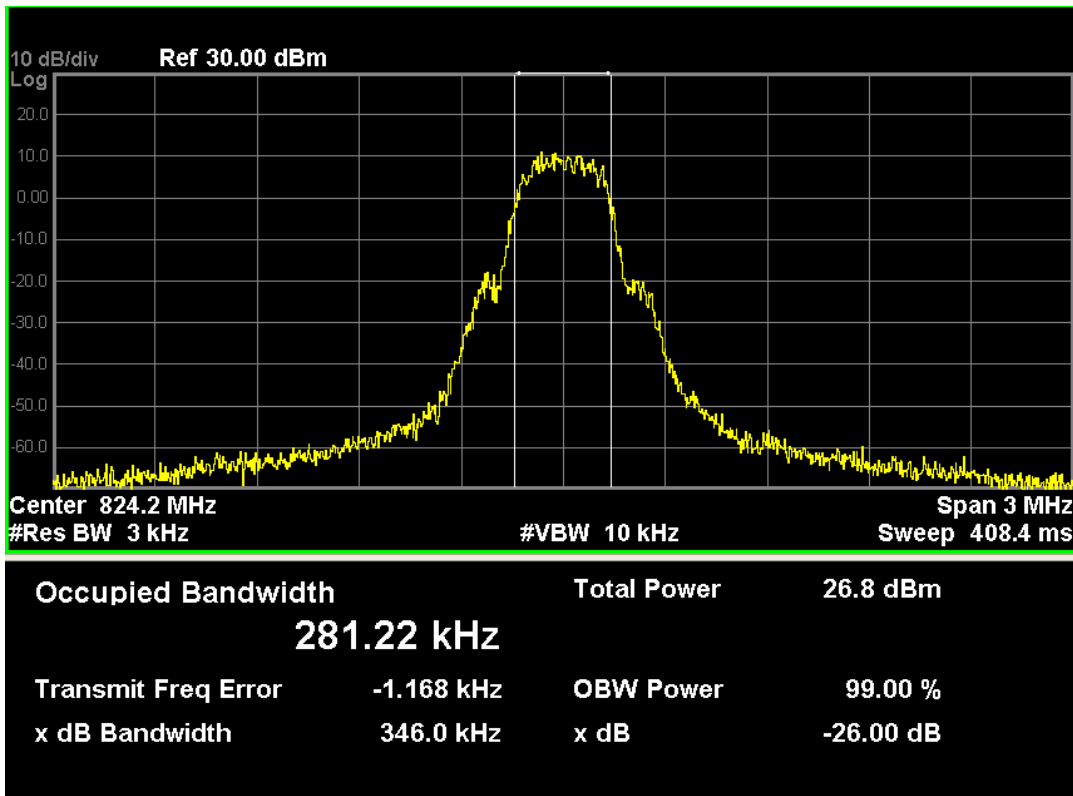

GSM850 (Channel 189)

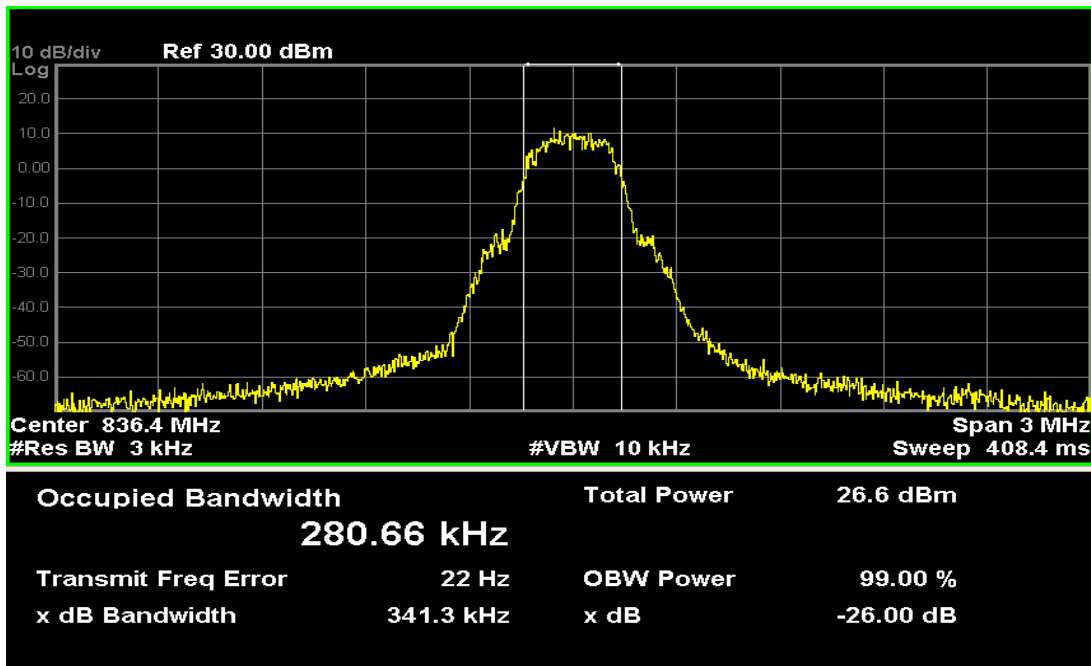

GSM 850 (Channel 251)

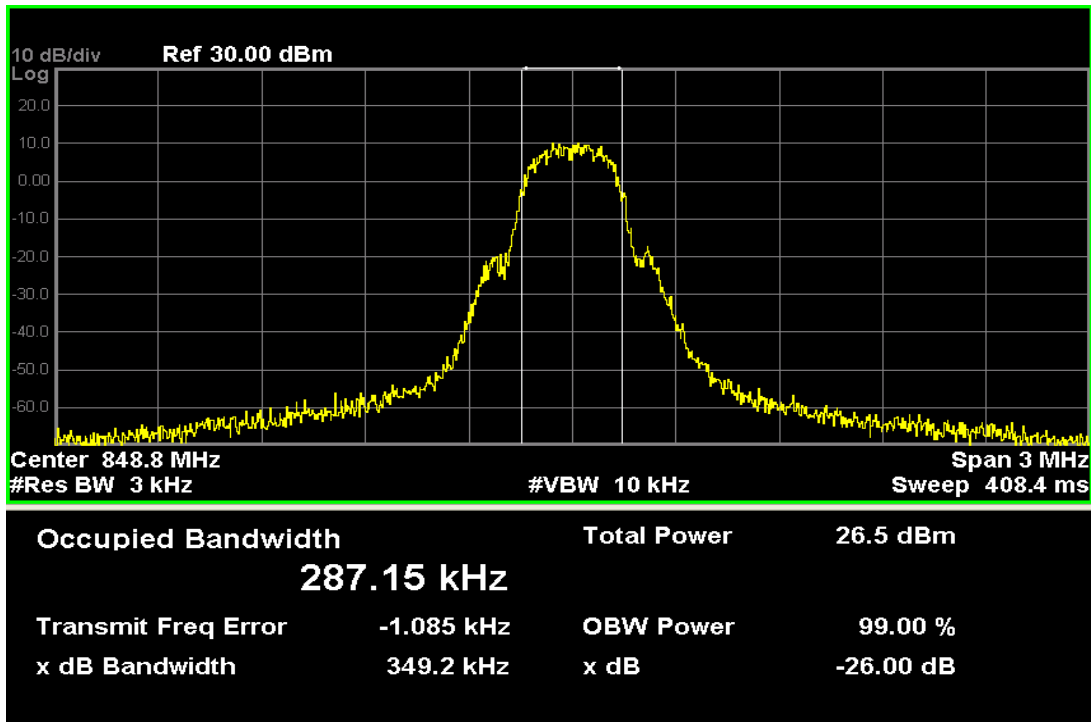

GPRS 850

Channel No.	Frequency (MHz)	-26dB Occupied Bandwidth (kHz)	99% Occupied Bandwidth (kHz)
128	824.20	338	278
189	836.40	346	289
251	848.80	344	285

GPRS 850 (Channel 128)

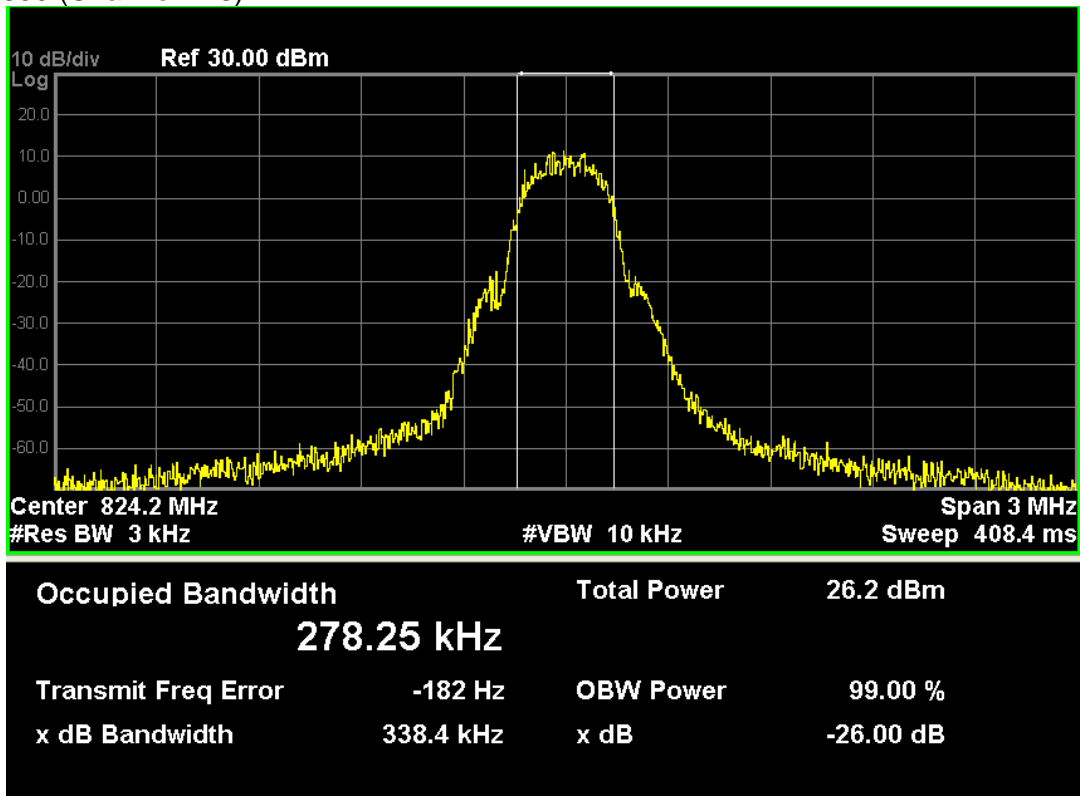

GPRS 850 (Channel 189)

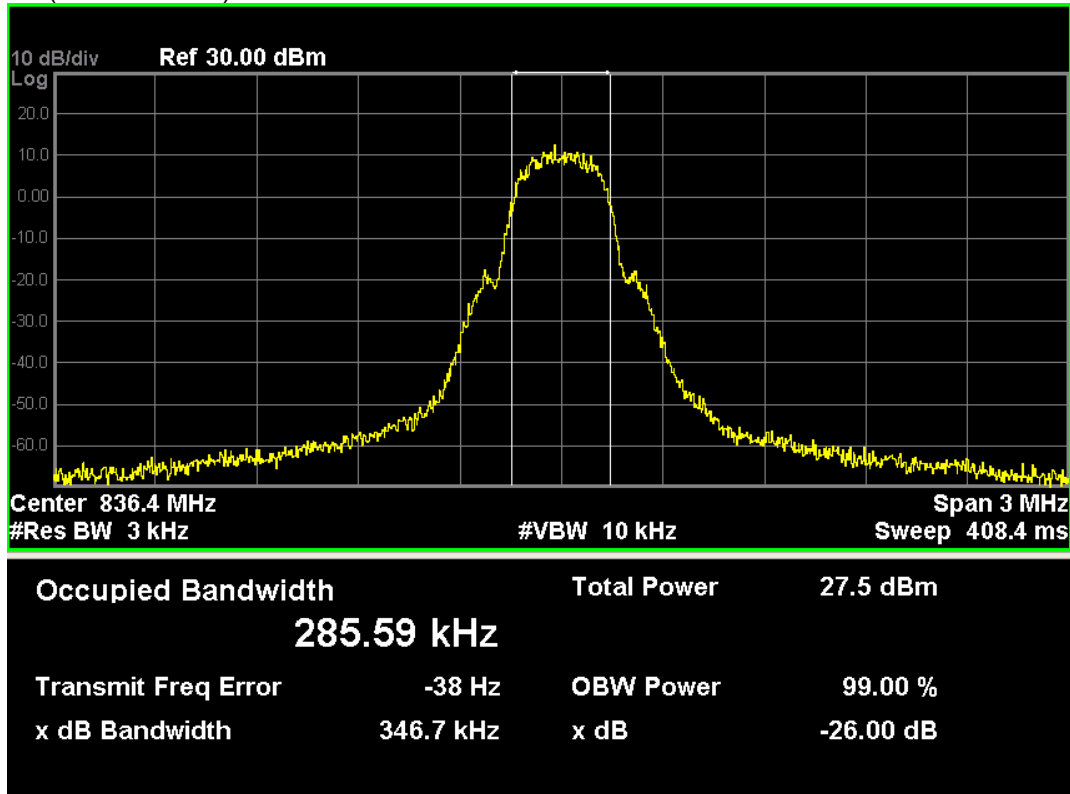

GPRS 850 (Channel 251)

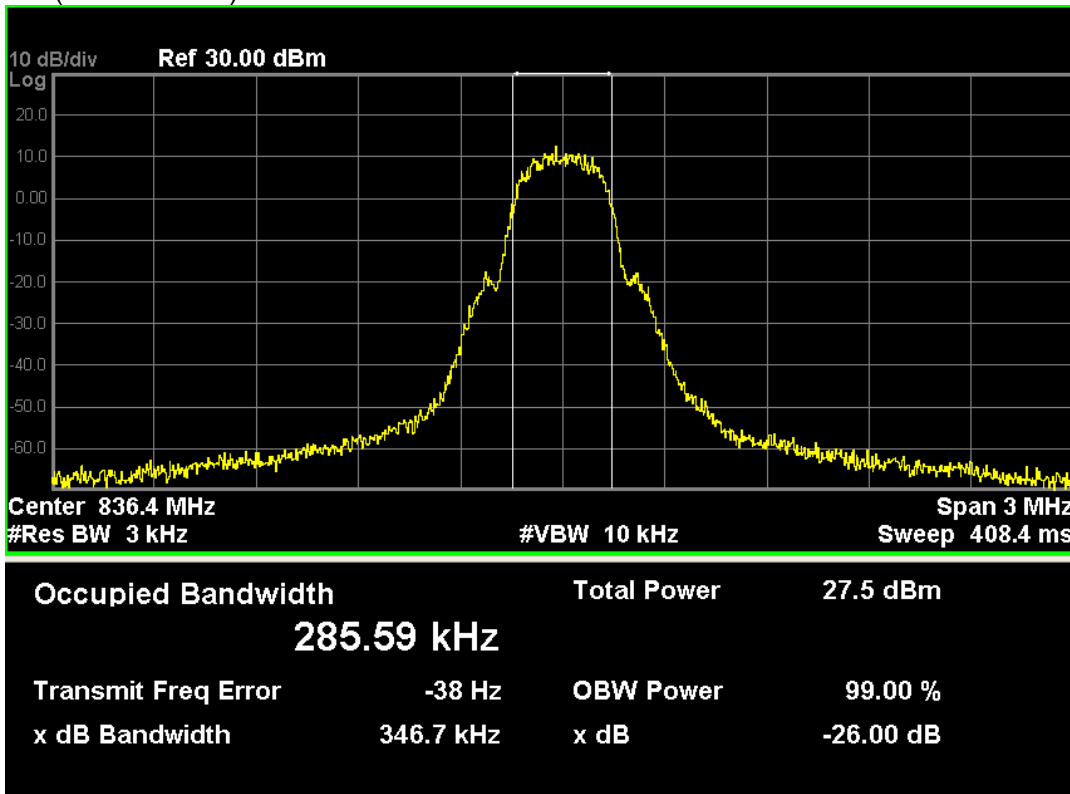

GSM1900

Channel No.	Frequency (MHz)	-26dB Occupied Bandwidth (kHz)	99% Occupied Bandwidth (kHz)
512	1850.20	331	272
661	1880.00	339	275
810	1909.80	337	271

GSM 1900 (Channel 512)

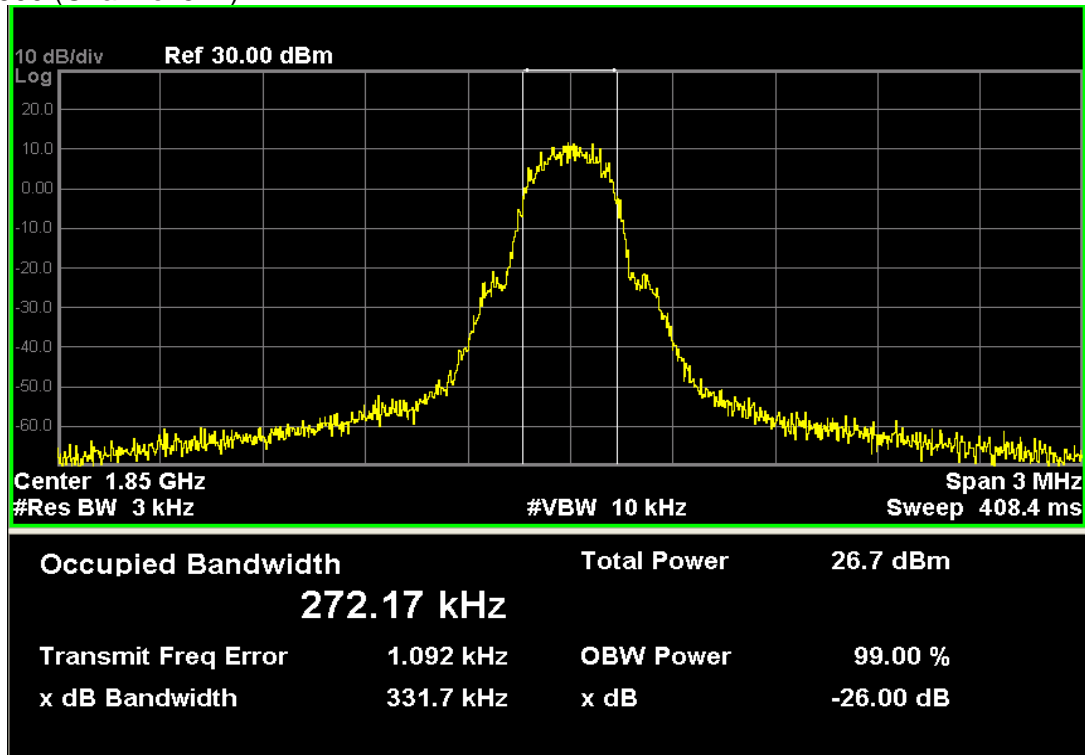

GSM 1900 (Channel 661)

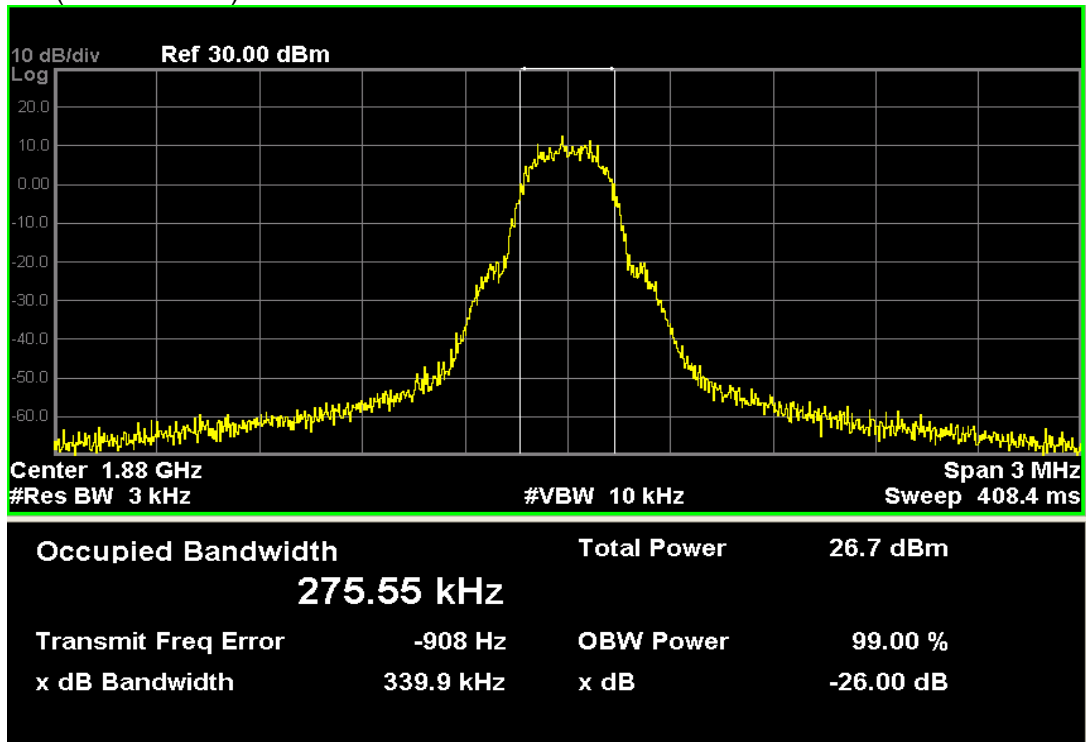

GSM 1900 (Channel 810)

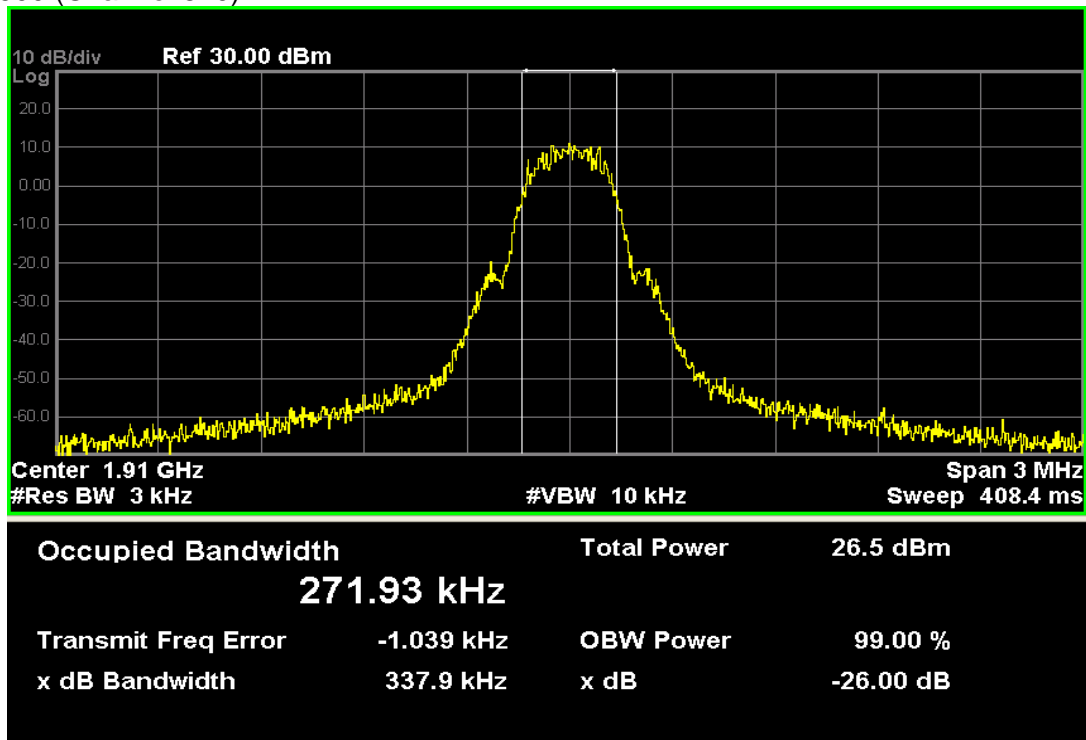

GPRS 1900

Channel No.	Frequency (MHz)	-26dB Occupied Bandwidth (kHz)	99% Occupied Bandwidth (kHz)
512	1850.20	336	270
661	1880.00	335	275
810	1909.80	339	273

GPRS 1900(Channel 512)

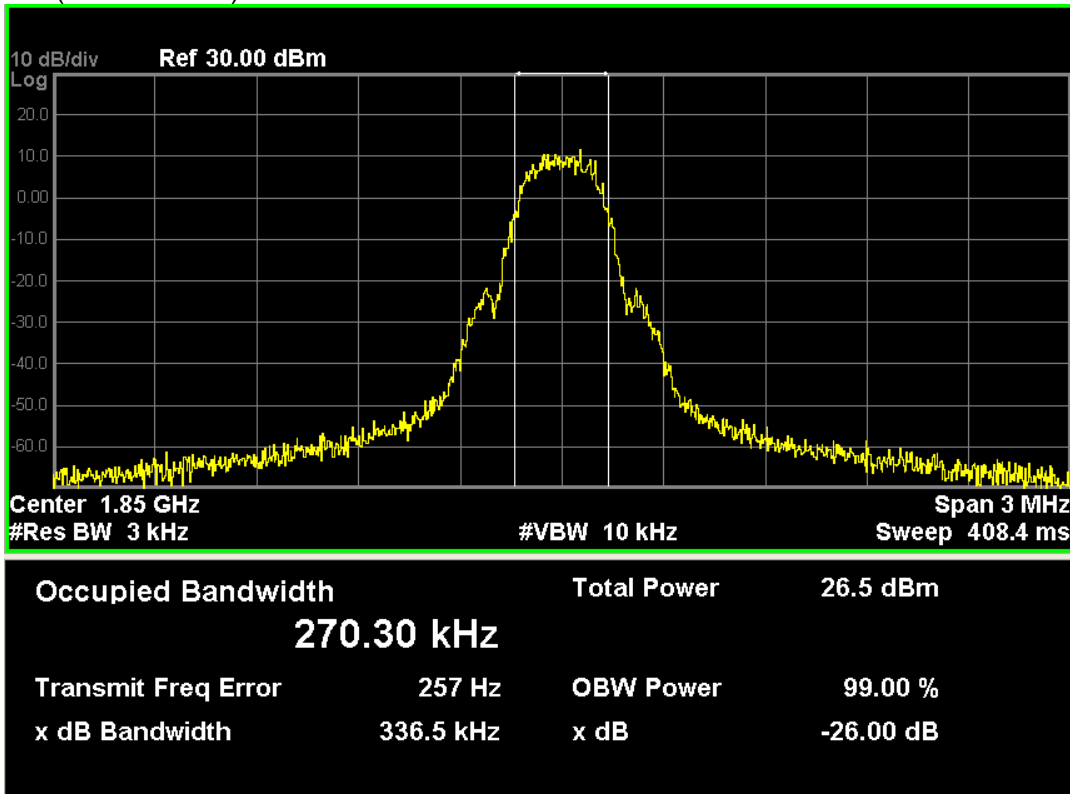

GPRS 1900 (Channel 661)

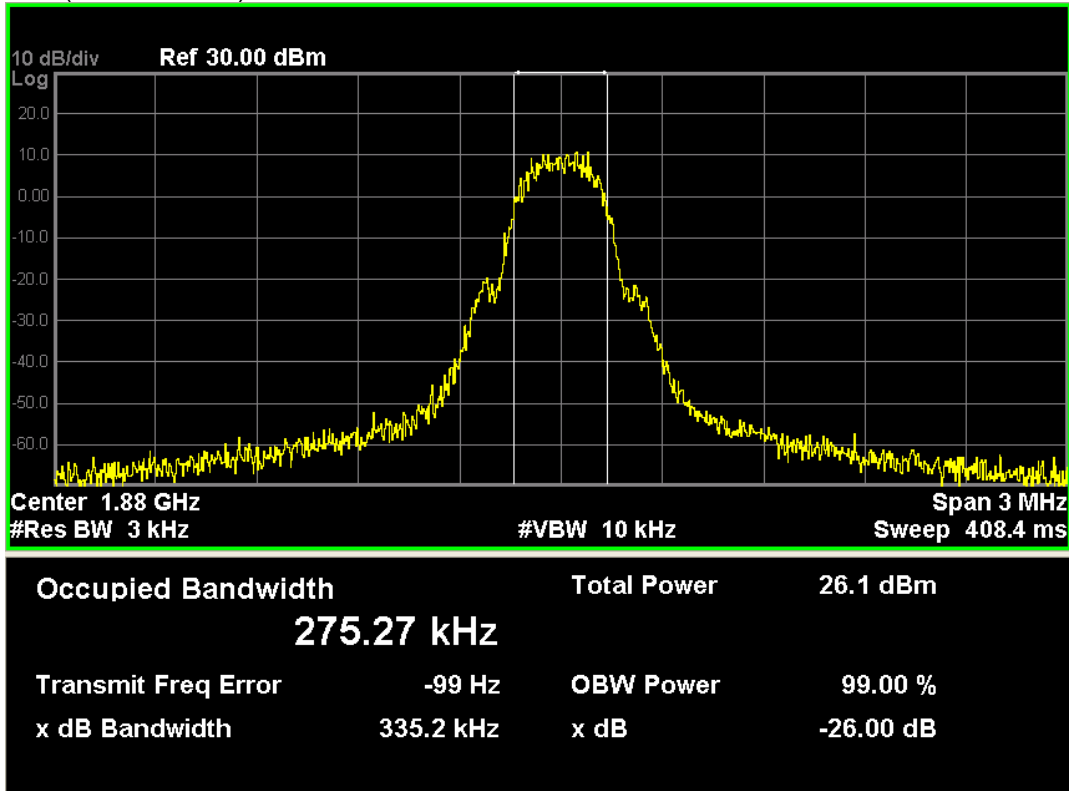

GPRS 1900 (Channel 810)

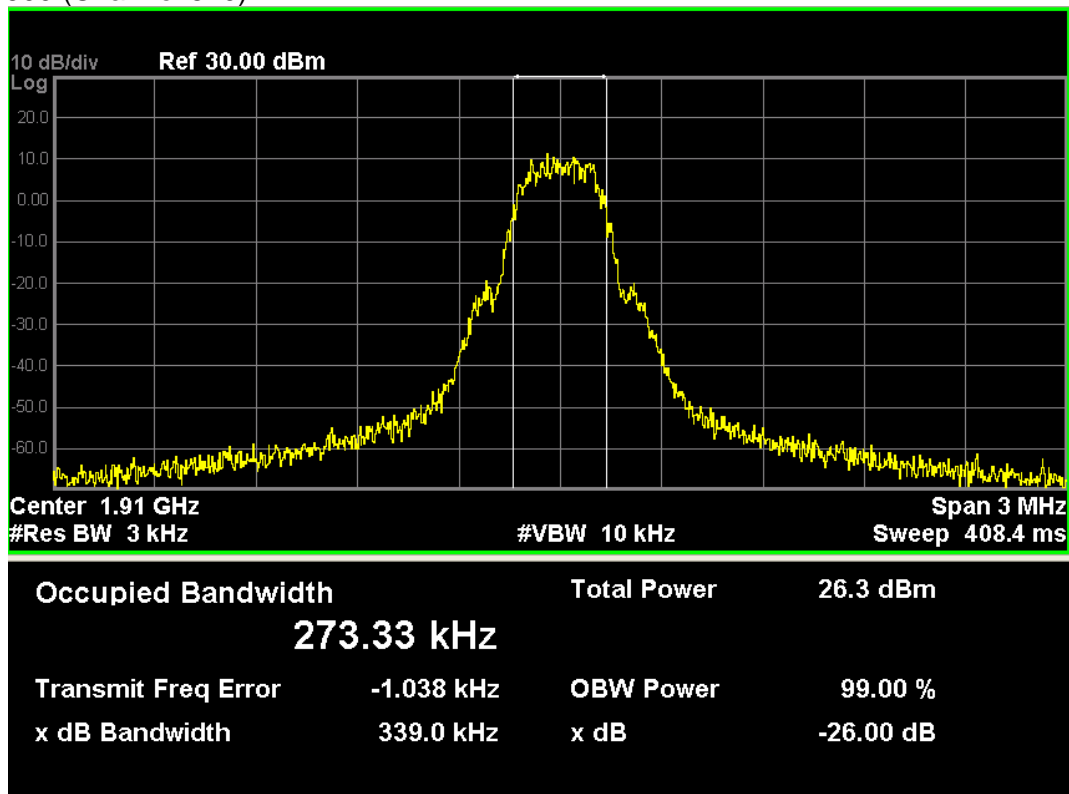

4.7. Test Photograph

Description: Occupied Bandwidth Test Setup

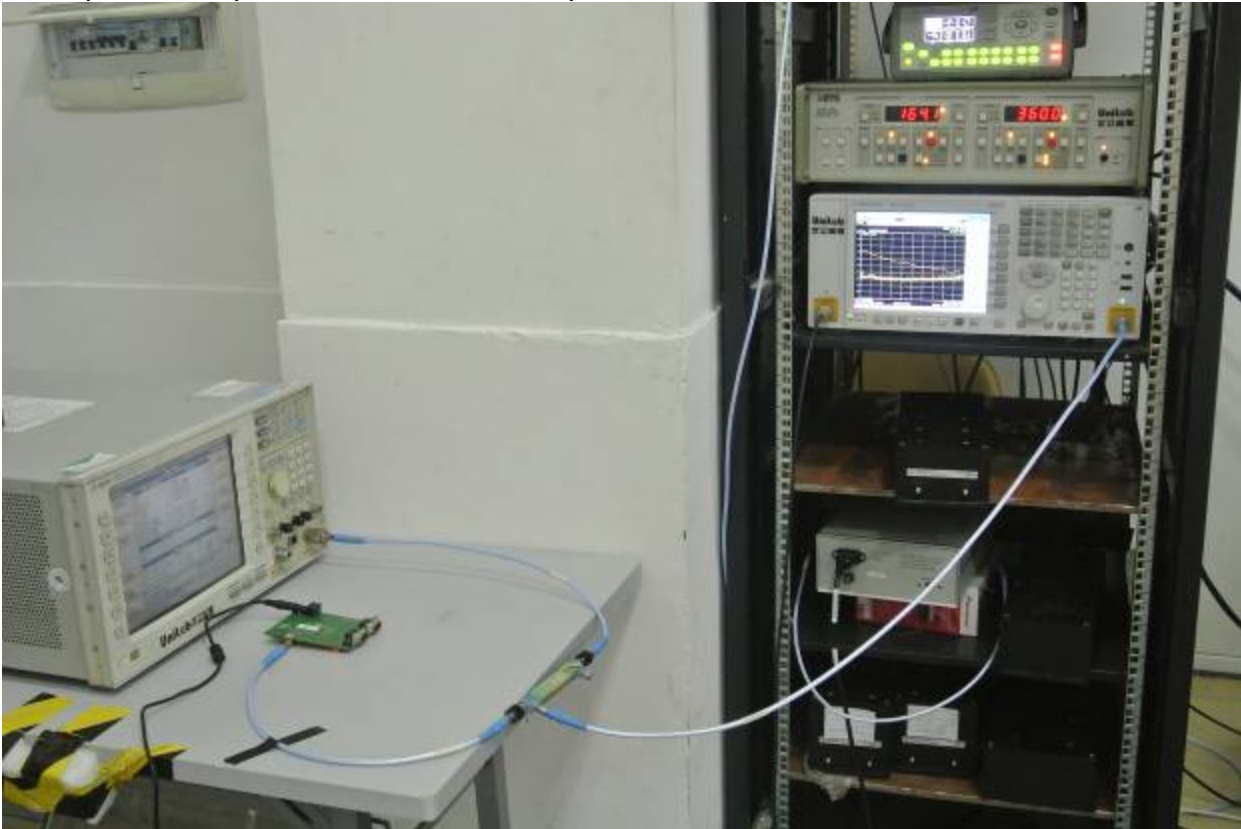

5. Spurious Emission At Antenna Terminals (+/- 1MHz)

5.1. Test Equipment

Instrument	Manufacturer	Model	Serial No	Cal. Date
Radio Communication Tester	Agilent	E5515C	GB46581718	2013.10.25
Spectrum Analyzer	Agilent	N9038A	MY51210142	2013.09.27
DC Power Supply	Agilent	6612C	MY43002989	2014.03.04

5.2. Test Setup

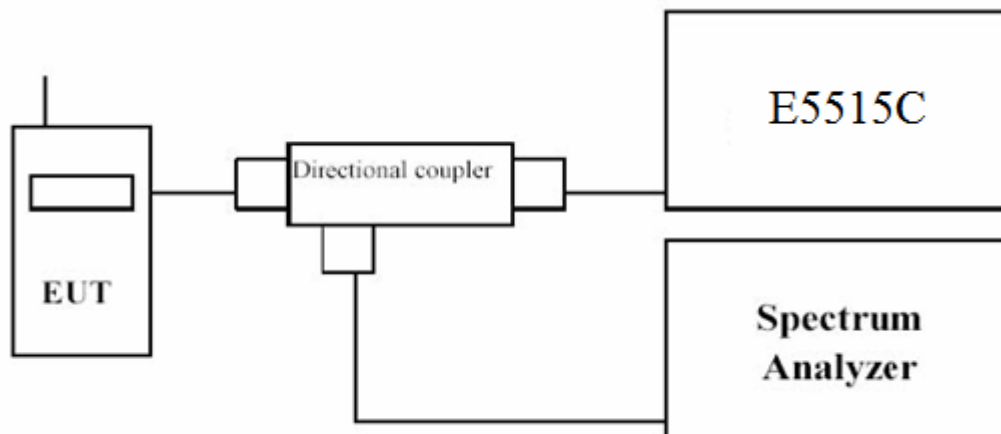

5.3. Limit

The power of any emission outside of the authorized operating frequency ranges must be attenuated below the transmitting power (P) by a factor of at least $43 + 10\log(P)$ dB.

5.4. Test Procedure

In the 1MHz bands immediately outside and adjacent to the frequency block a resolution bandwidth of at least one percent of the emission bandwidth of the fundamental emission of the transmitter may be employed to measure the out of band Emissions.

5.5. Uncertainty

The measurement uncertainty is defined as ± 1.2 dB.

5.6. Test Result

GSM 850 (Channel 128)

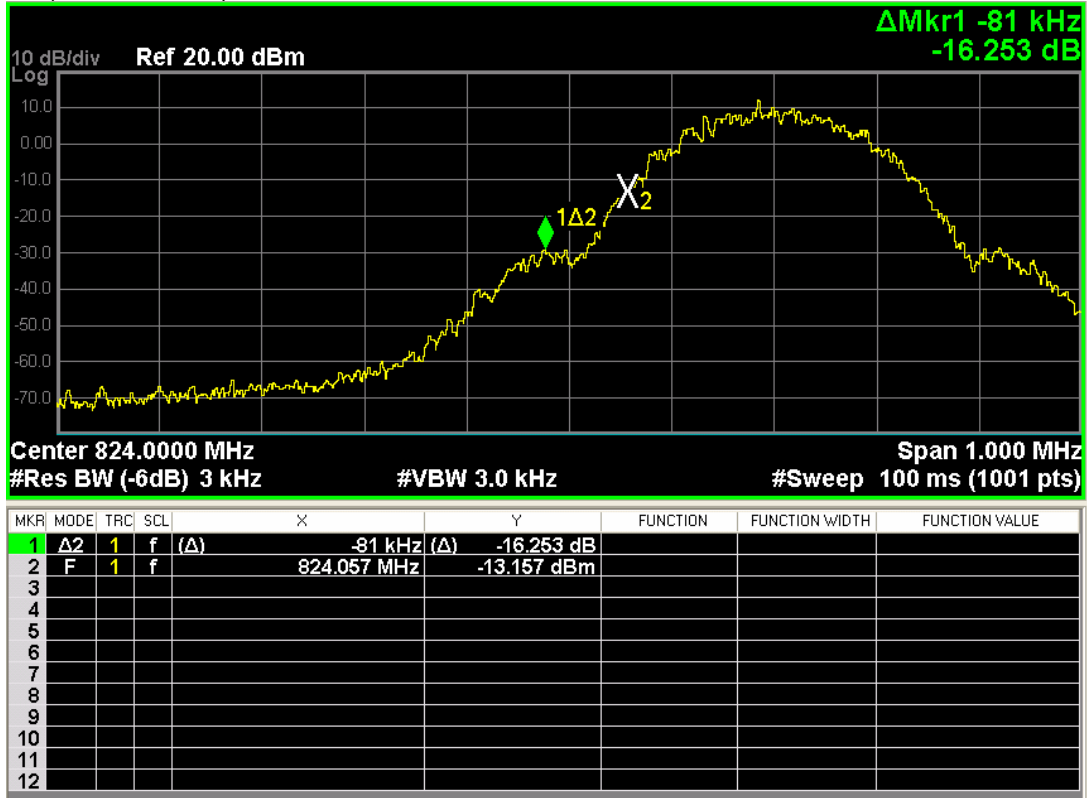

GSM 850 (Channel 251)

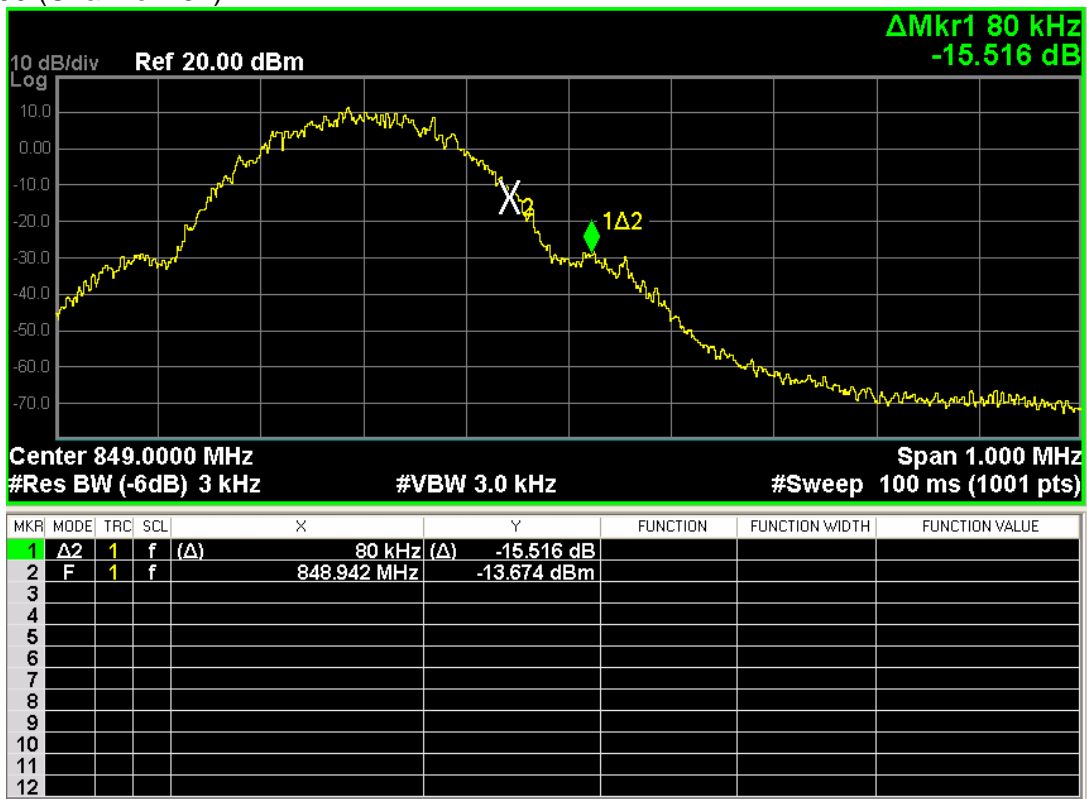

GSM1900 (Channel 512)

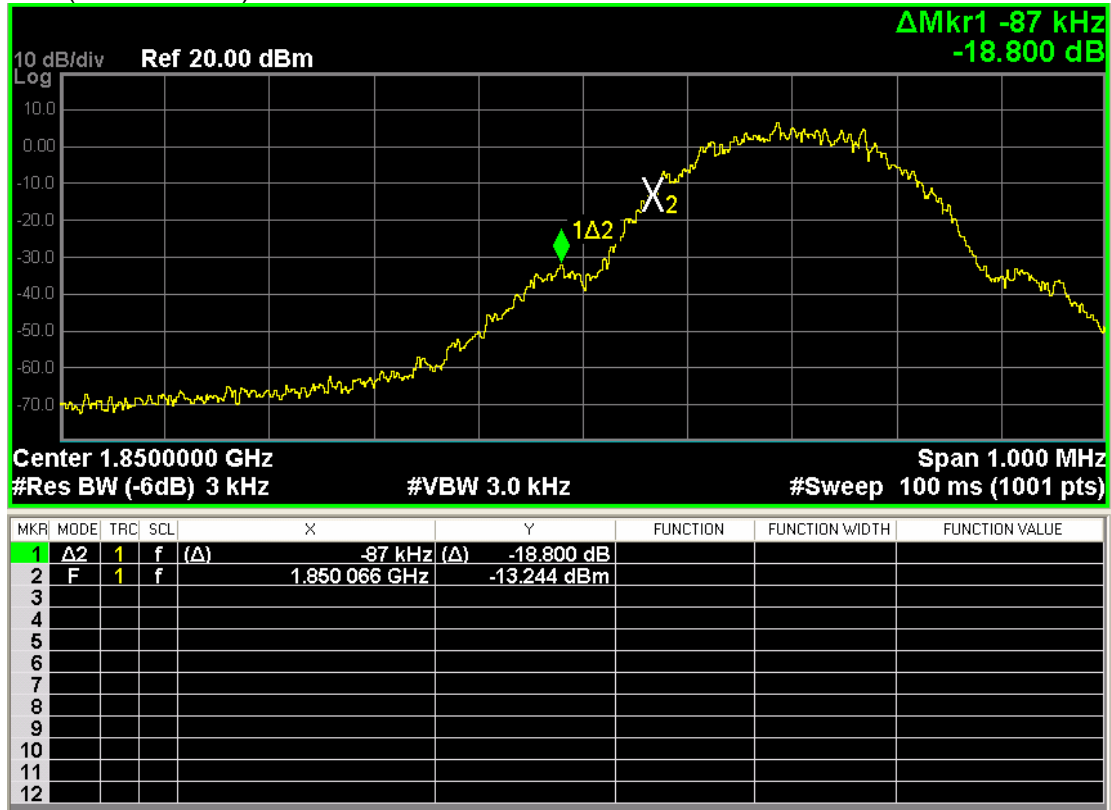

GSM1900 (Channel 810)

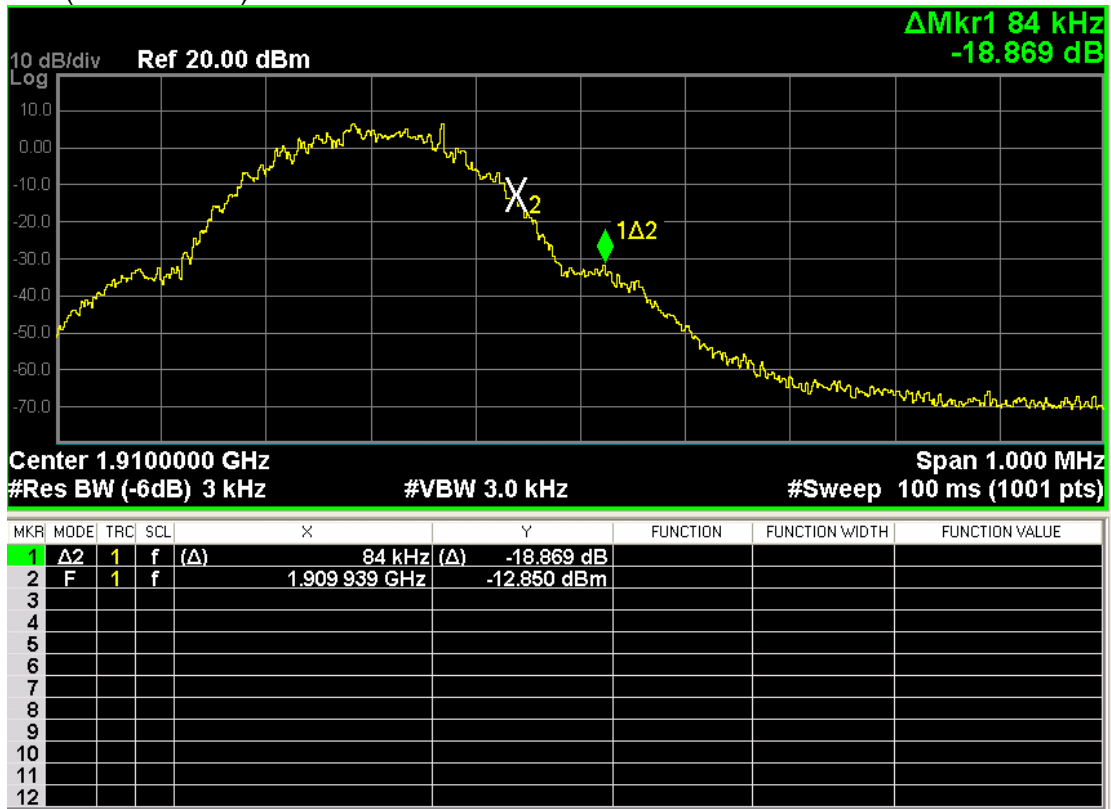

GPRS 850 (Channel 128)

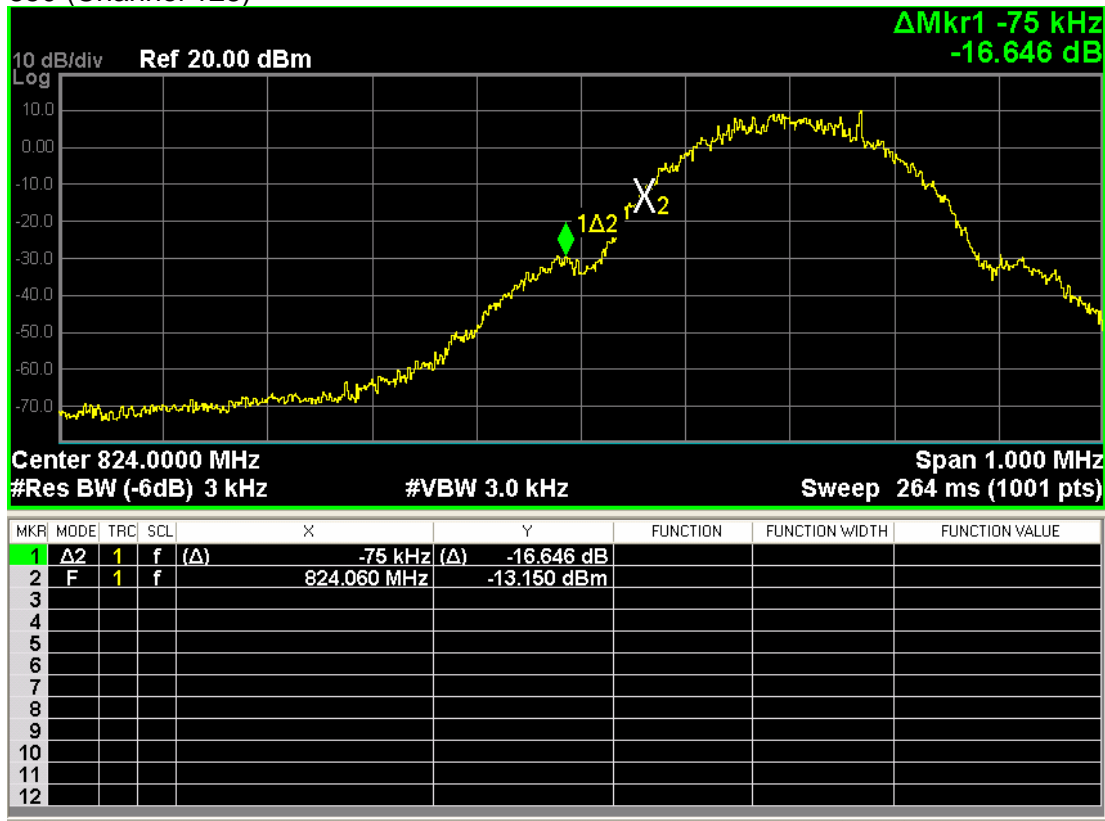

GPRS 850 (Channel 251)

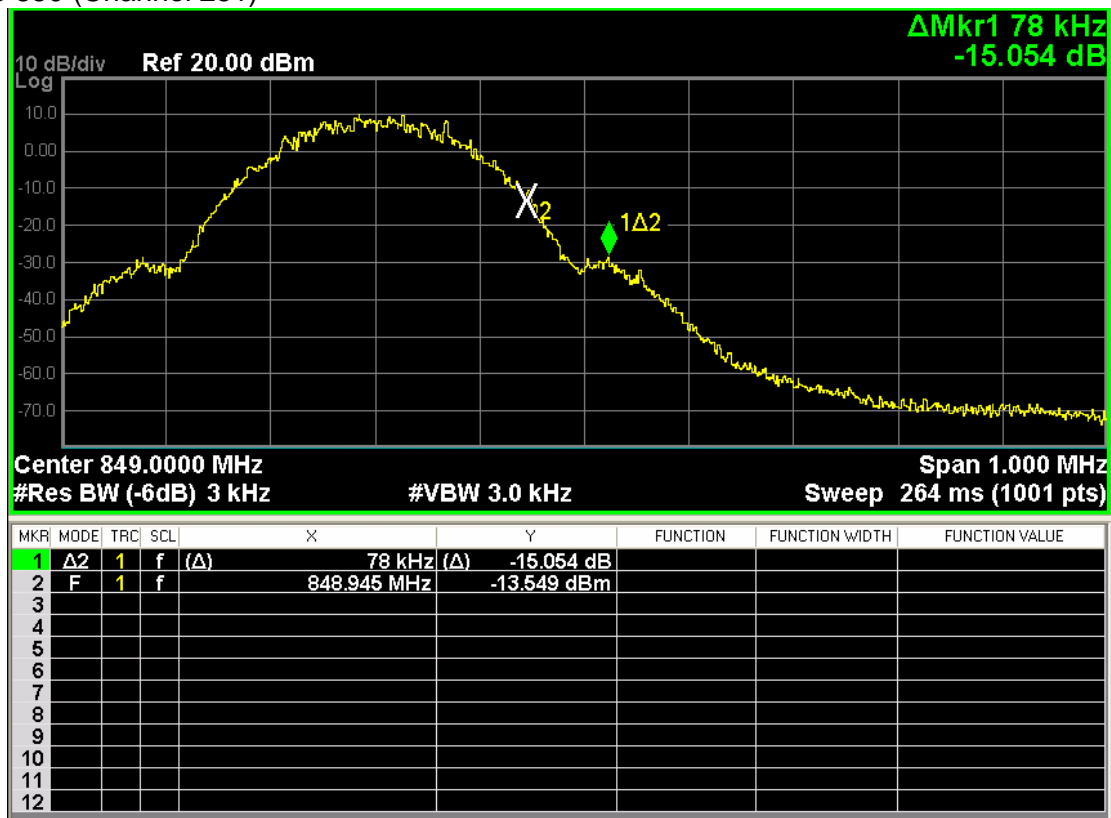

GPRS 1900 (Channel 512)

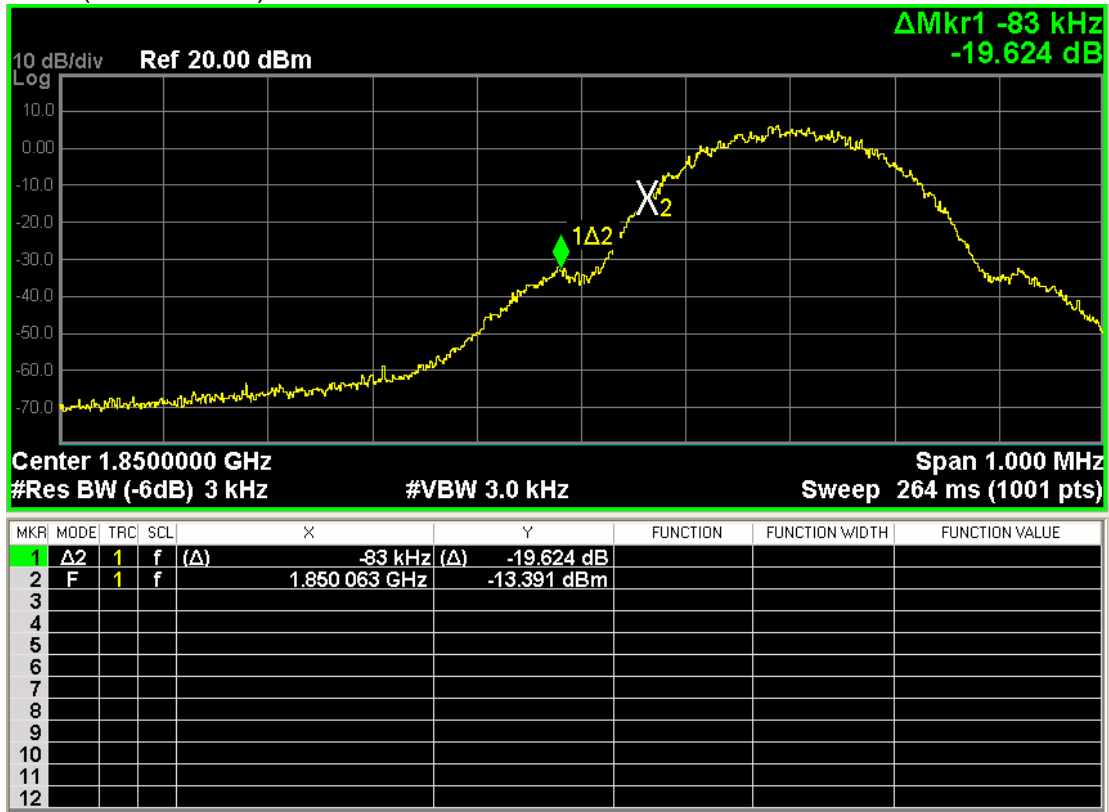

GPRS 1900 (Channel 810)

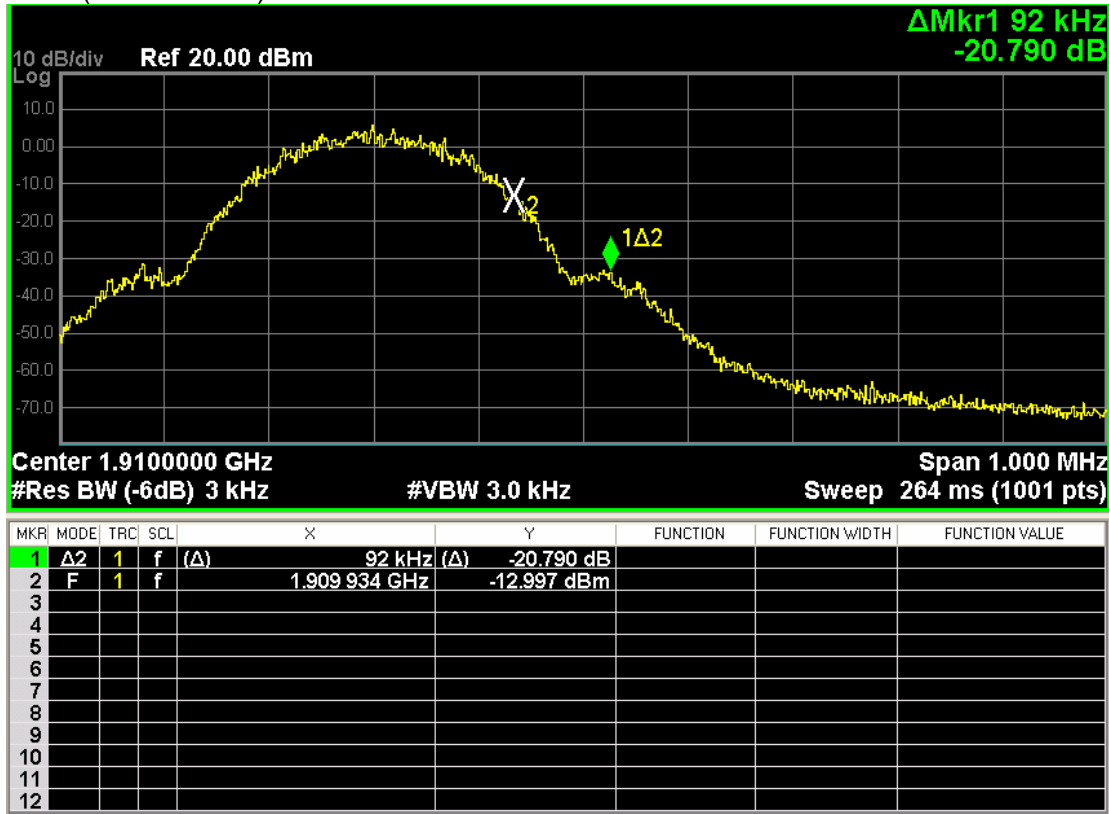

5.7. Test Photograph

Description: Spurious Emission At Antenna Terminals Test Setup



6.Spurious Emission

6.1. Test Equipment

Instrument	Manufacturer	Model	Serial No.	Cali. Due Date
Spectrum Analyzer	Agilent	N9038A	MY51210142	2013.09.27
Radio Communication Tester	Agilent	E5515C	GB46581718	2013.10.25
Signal Generator	Agilent	N5183A	MY50140938	2013.10.08
Preamplifier	CEM	EM30180	3008A0245	2014.03.01
DC Power Supply	Agilent	6612C	MY43002989	2014.03.04
Bilog Antenna	Schwarzbeck	VULB9160	9160-3316	2013.09.19
VHF-UHF-Biconical Antenna	Schwarzbeck	VUBA9117	9117-263	2013.09.19
Broad-Band Horn Antenna	Schwarzbeck	BBHA9120D	9120D-942	2013.09.19
Broad-Band Horn Antenna	Schwarzbeck	BBHA9120D	9120D-943	2013.09.19

6.2. Test Setup

Conducted Spurious Emission Measurement:

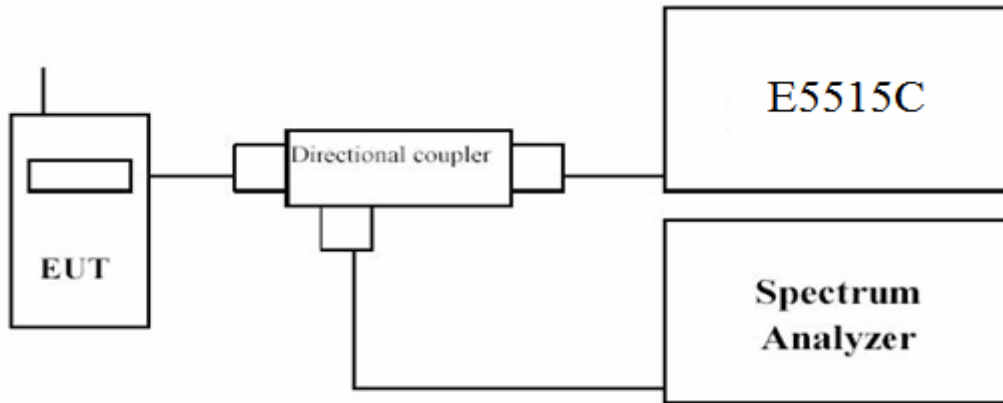

Radiated Spurious Measurement: below 1GHz

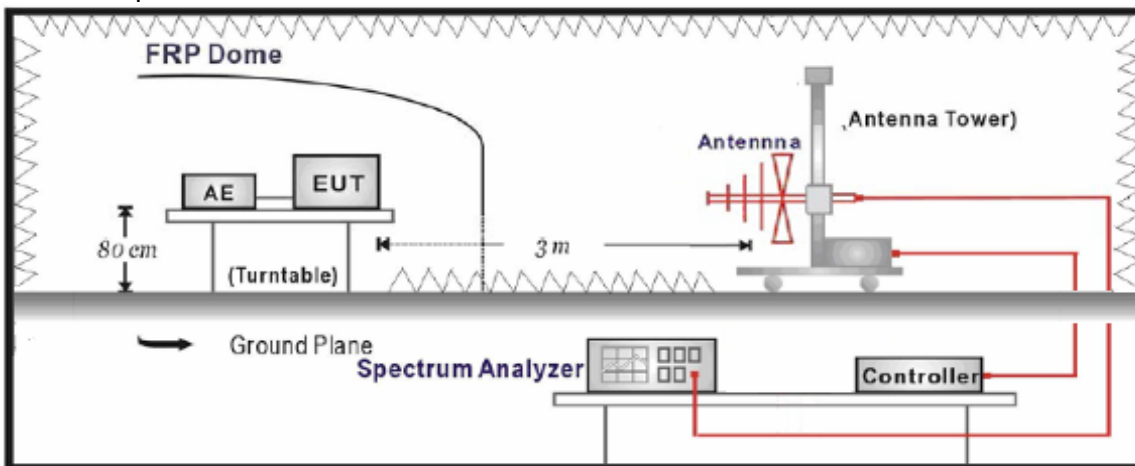

Radiated Spurious Measurement: above 1GHz

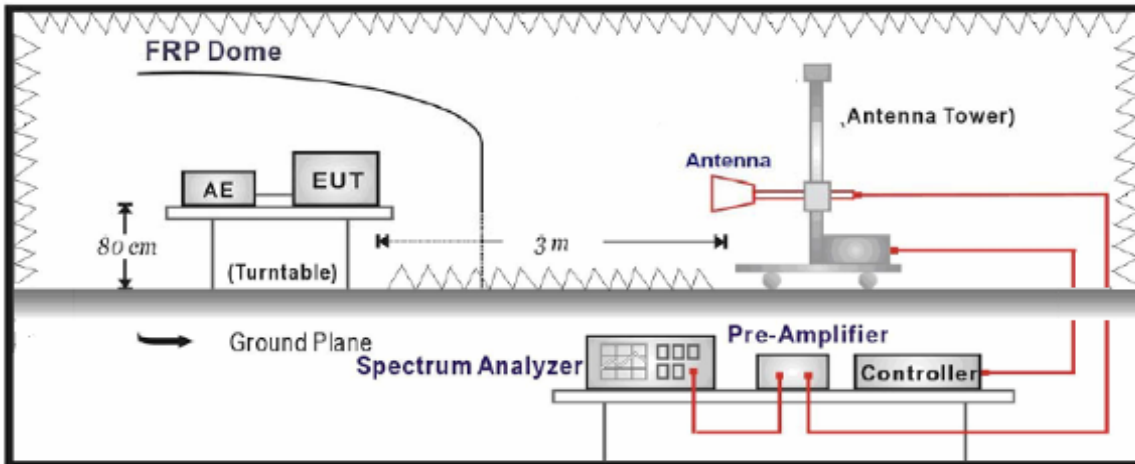

6.3. Limit

The power of any emission outside of the authorized operating frequency ranges must be attenuated below the transmitting power (P) by a factor of at least $43 + 10\log(P)$ dB.

6.4. Test Procedure

Conducted Spurious Measurement:

- a. Place the EUT on a bench and set it in transmitting mode.
- b. Connect a low loss RF cable from the antenna port to a spectrum analyzer and E5515C by a Directional Couple.
- c. EUT Communicate with E5515C, then select a channel for testing.
- d. Add a correction factor to the display of spectrum, and then test.
- e. The resolution bandwidth of the spectrum analyzer was set at 1 MHz, sufficient scans were taken to show the out of band Emission if any up to 10th harmonic.

Radiated Spurious Measurement:

- a. The EUT shall be placed at the specified height on a support, and in the position closest to normal use as declared by provider.
- b. The test antenna shall be oriented initially for vertical polarization and shall be chosen to correspond to the frequency of the transmitter
- c. The output of the test antenna shall be connected to the measuring receiver. The transmitter shall be switched on and the measuring receiver shall be tuned to the frequency of the transmitter under test.
- d. The test antenna shall be raised and lowered through the specified range of height until a maximum signal level is detected by the measuring receiver.
- e. The transmitter shall then be rotated through 360° in the horizontal plane, until the maximum signal level is detected by the measuring receiver.
- f. The test antenna shall be raised and lowered again through the specified range of height until a maximum signal level is detected by the measuring receiver.
- h. The maximum signal level detected by the measuring receiver shall be noted.
- i. The transmitter shall be replaced by a substitution antenna.
- j. The substitution antenna shall be orientated for vertical polarization and the length of the substitution antenna shall be adjusted to correspond to the frequency of the transmitter.
- k. The substitution antenna shall be connected to a calibrated signal generator.
- l. If necessary, the input attenuator setting of the measuring receiver shall be adjusted in order to increase the sensitivity of the measuring receiver.
- m. The test antenna shall be raised and lowered through the specified range of height to ensure that the maximum signal is received.
- n. The input signal to the substitution antenna shall be adjusted to the level that produces a level detected by the measuring receiver, that is equal to the level noted while the transmitter radiated power was measured, corrected for the change of input attenuator setting of the measuring receiver.
- o. The measurement shall be repeated with the test antenna and the substitution antenna orientated for horizontal polarization.
- p. The measure of the effective radiated power is the larger of the two levels recorded at the input to

the substitution antenna, corrected for gain of the substitution antenna if necessary.
q. The frequency range was checked up to 10th harmonic.
r. Test site anechoic chamber refer to ANSI C63.4: 2009

6.5. Uncertainty

The measurement uncertainty is defined as 3.2 dB for Radiated Power Measurement.

6.6. Test Result

Conducted Spurious Measurement:

GSM850 Channel 189

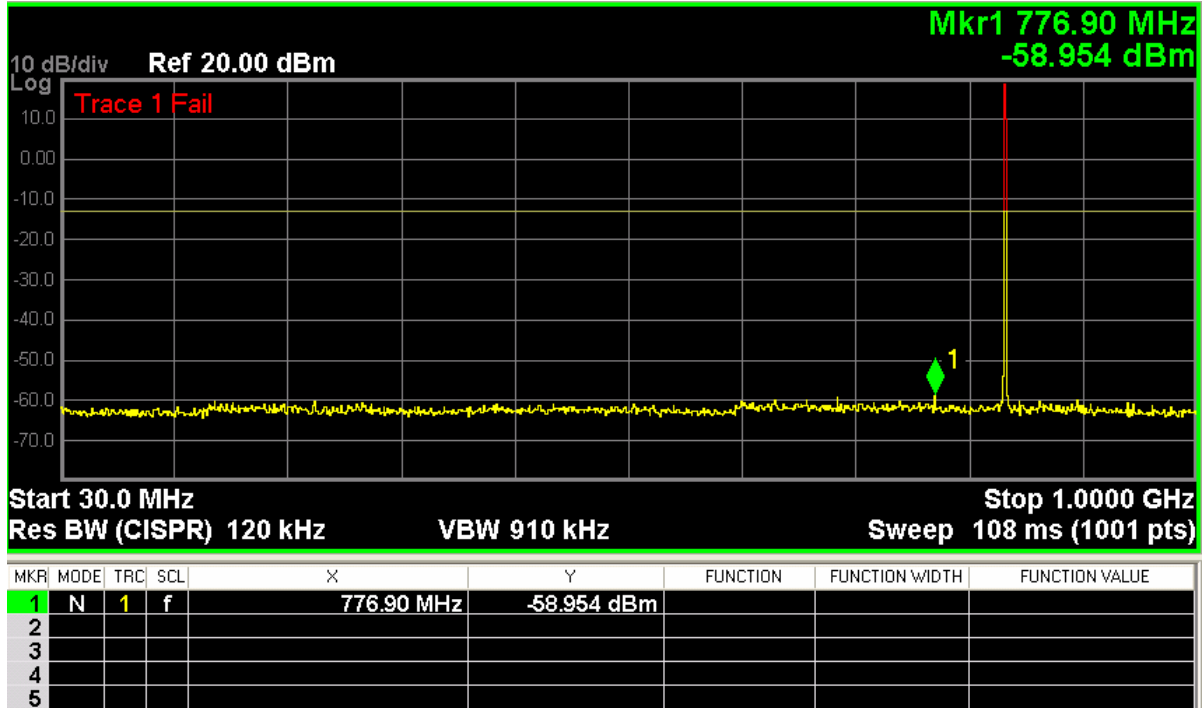

Note: The signal right of point 1 is carrier

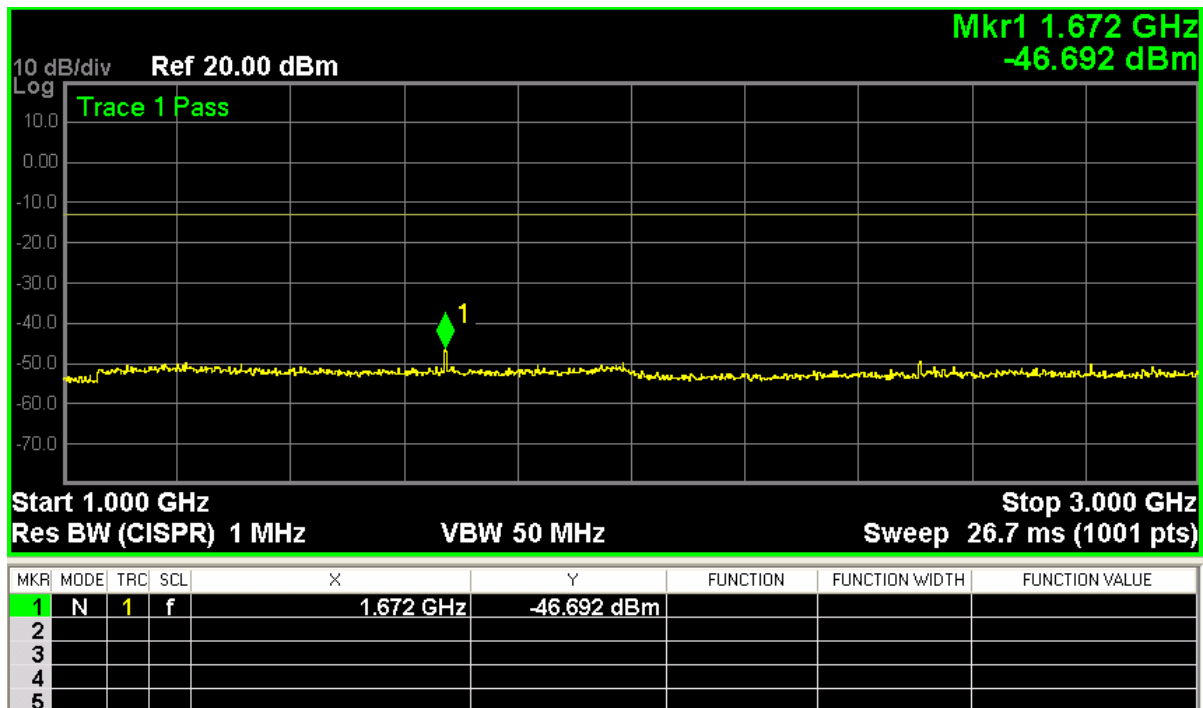

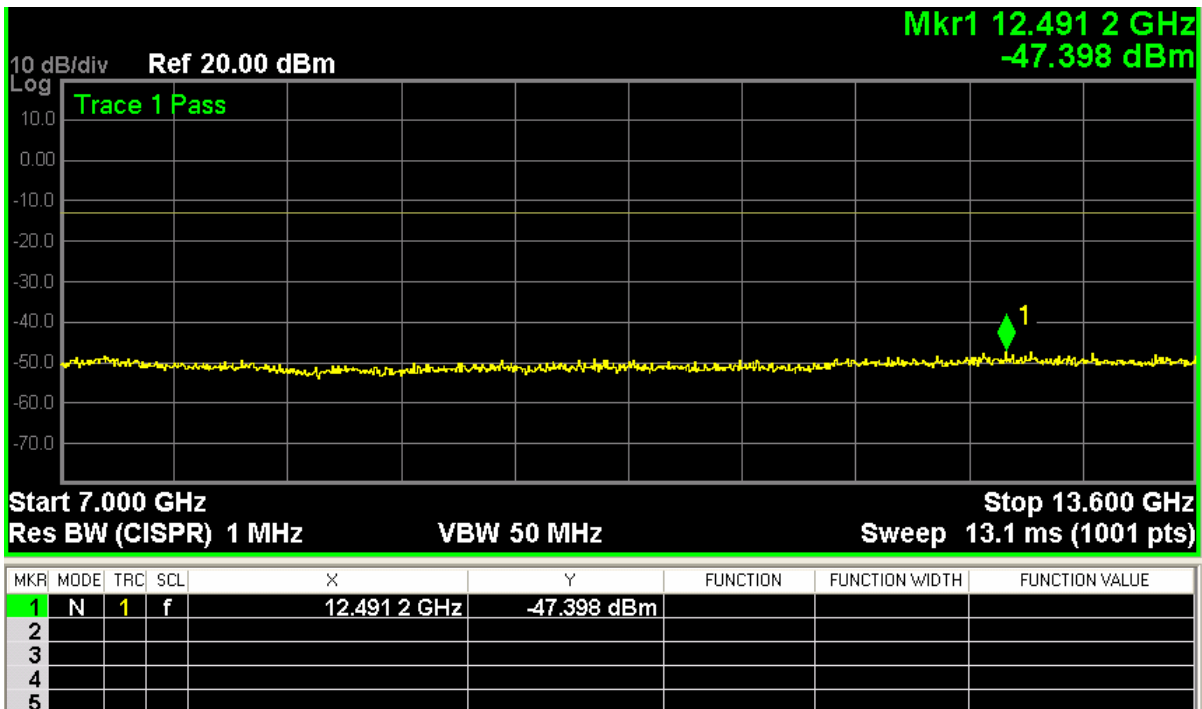
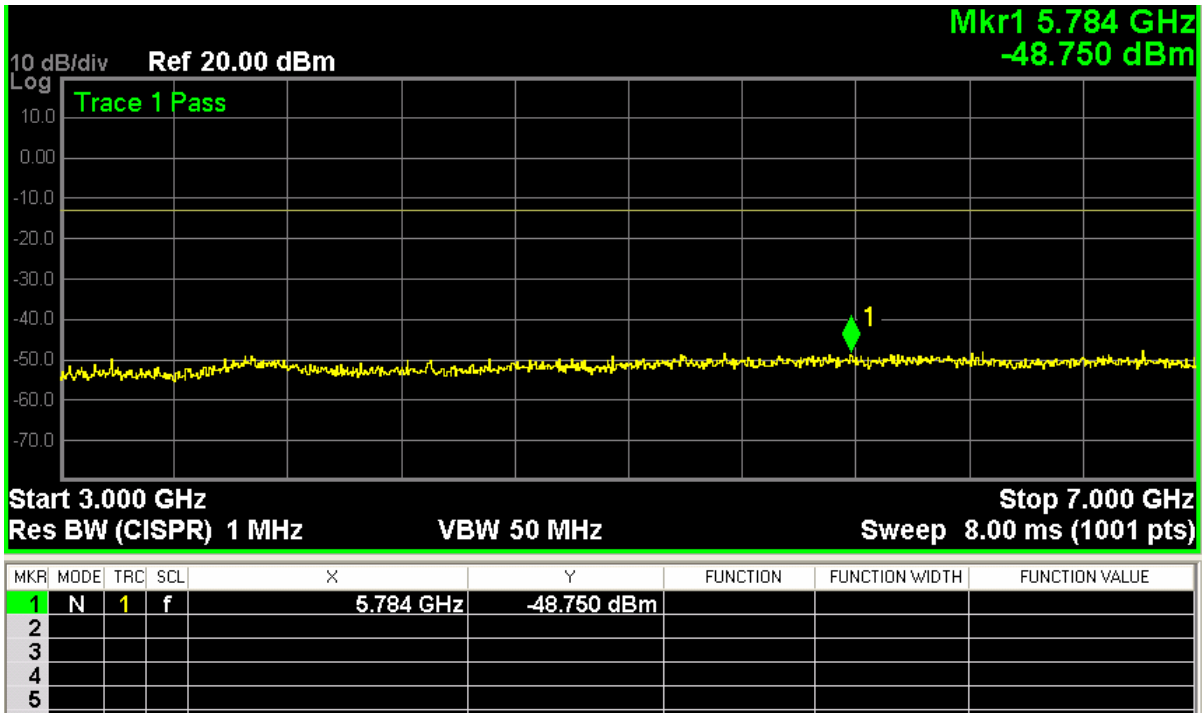

GSM1900 Channel 661

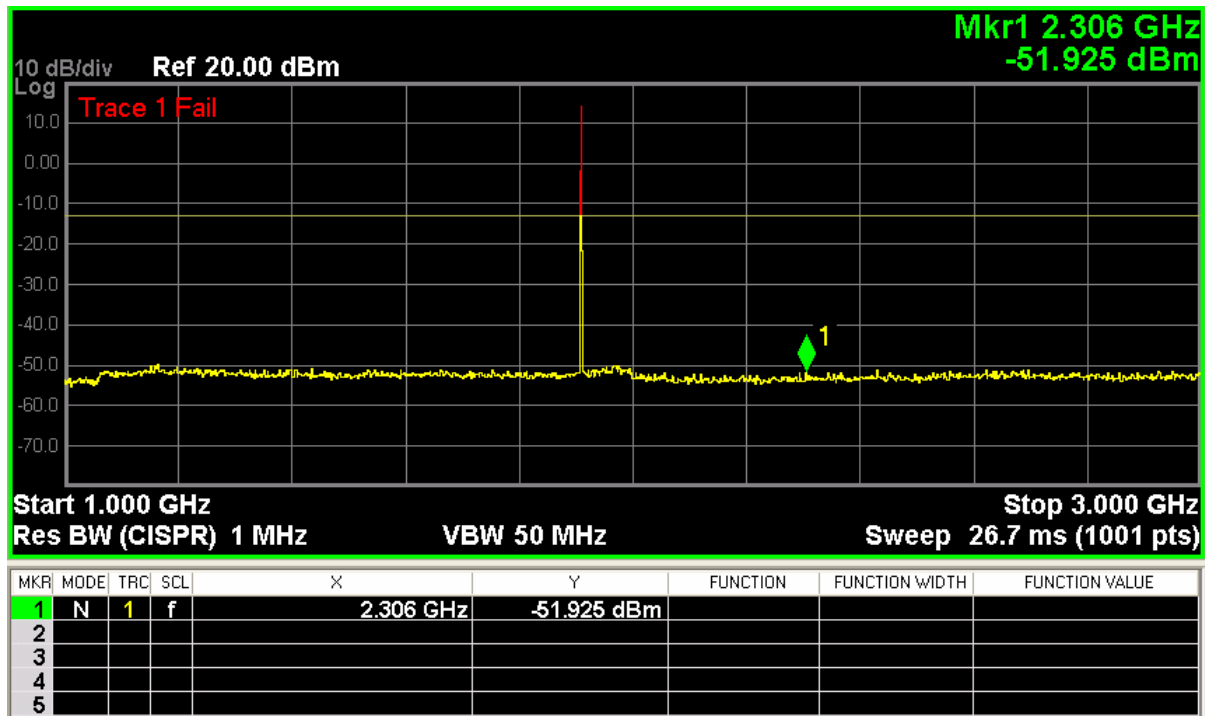
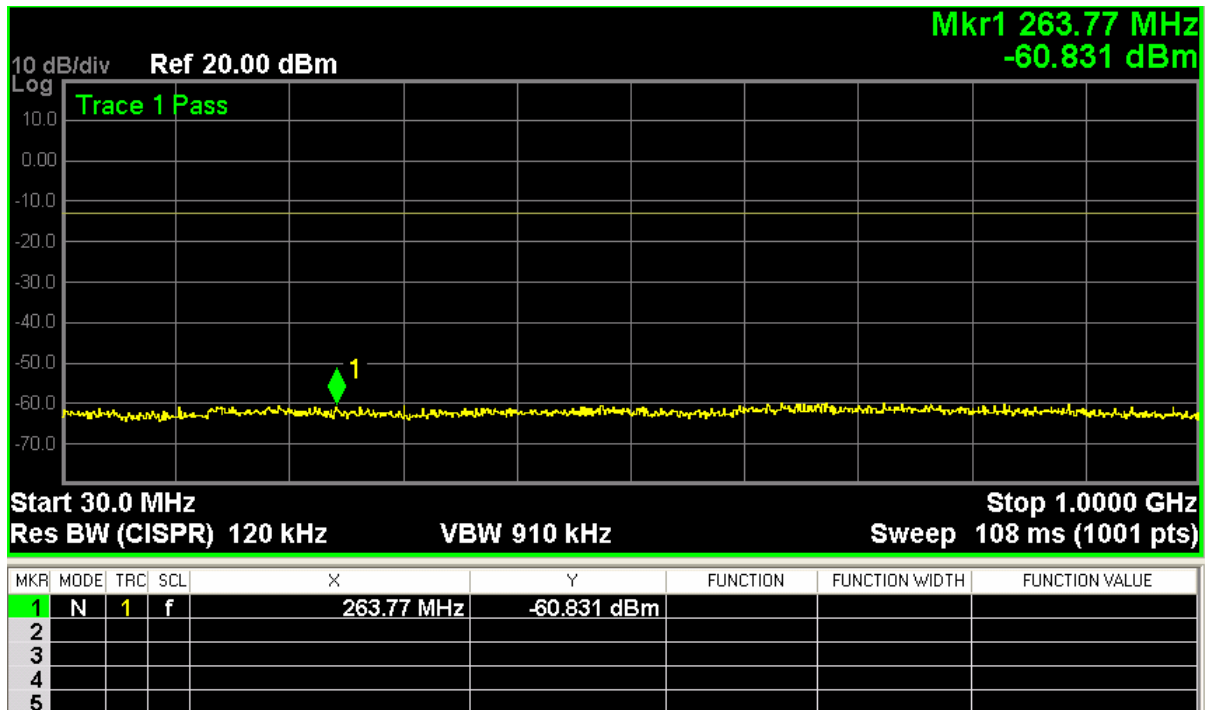

Note: The signal left of point 1 is carrier

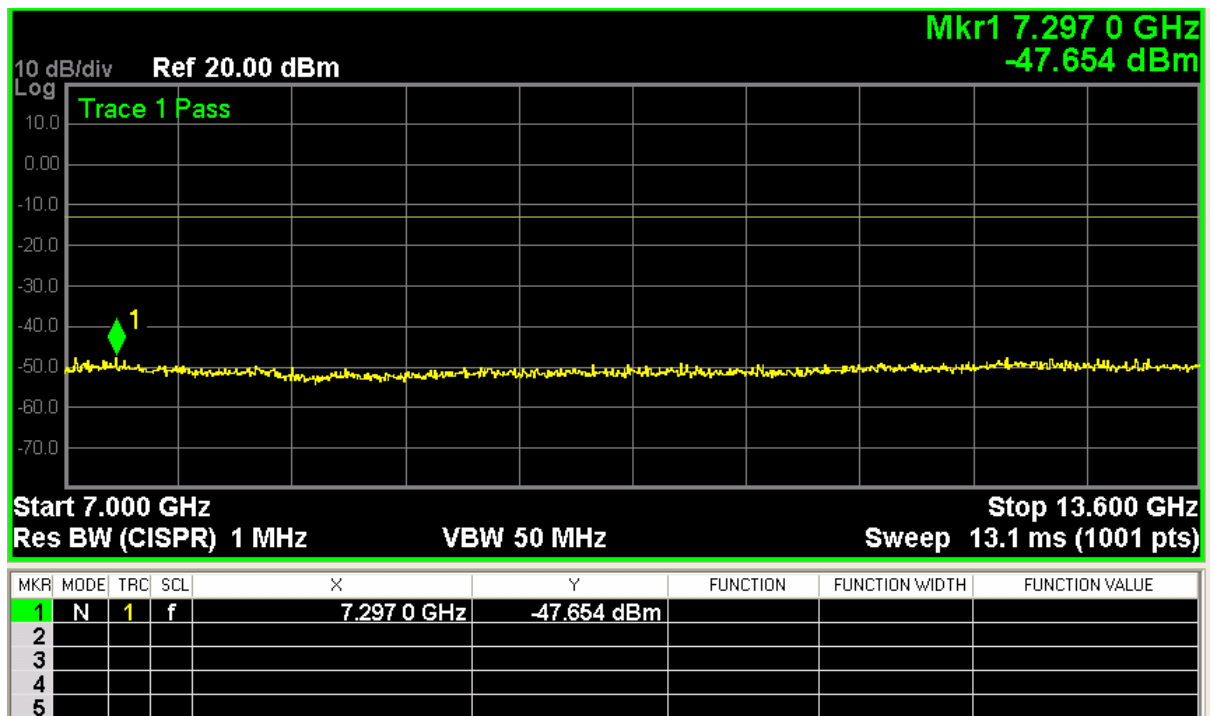
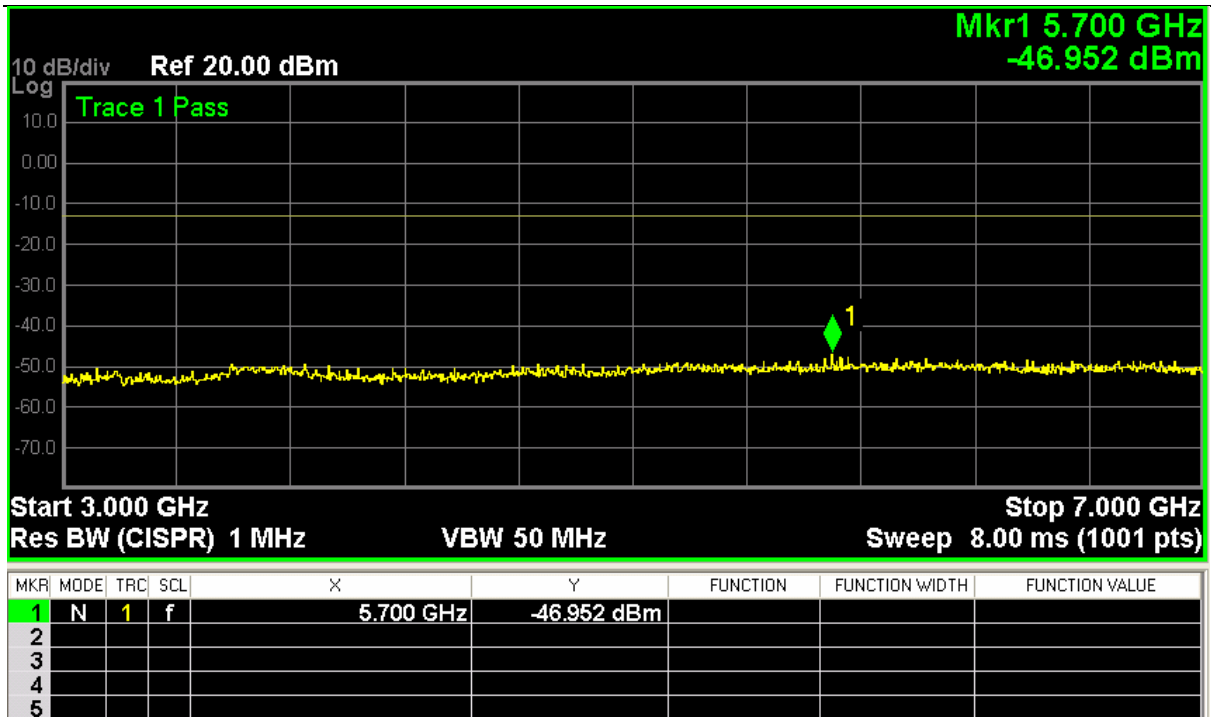

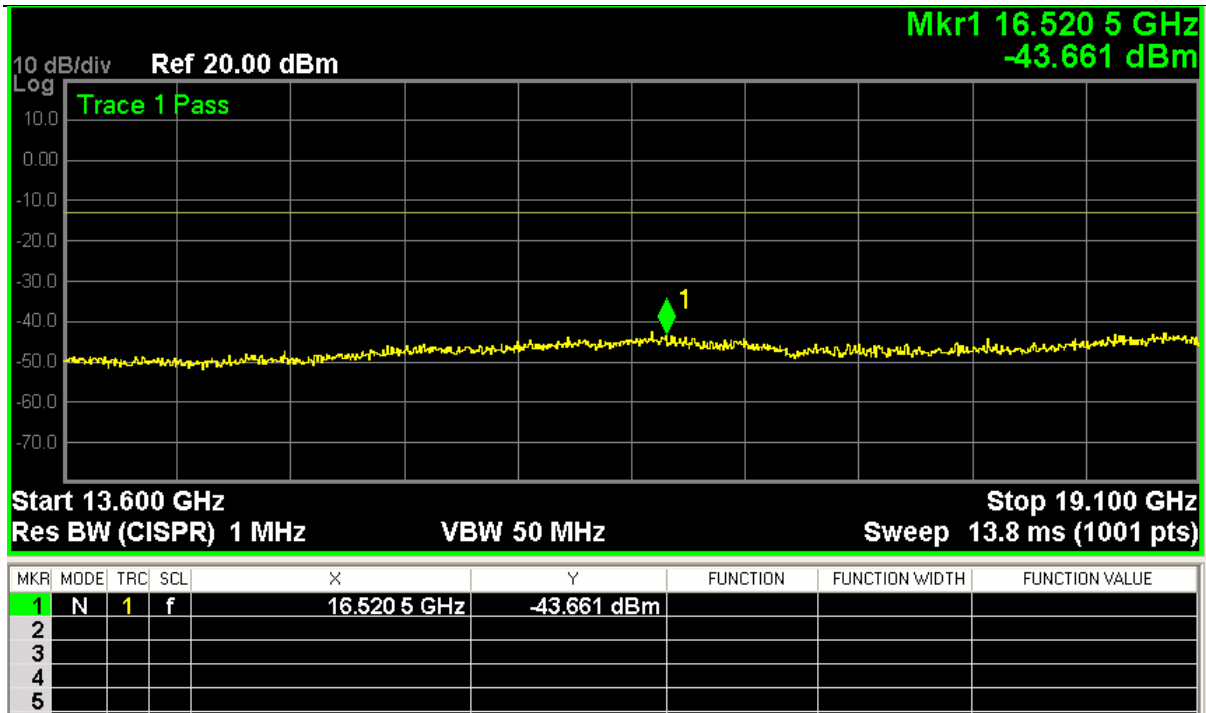

GPRS 850Channel 189

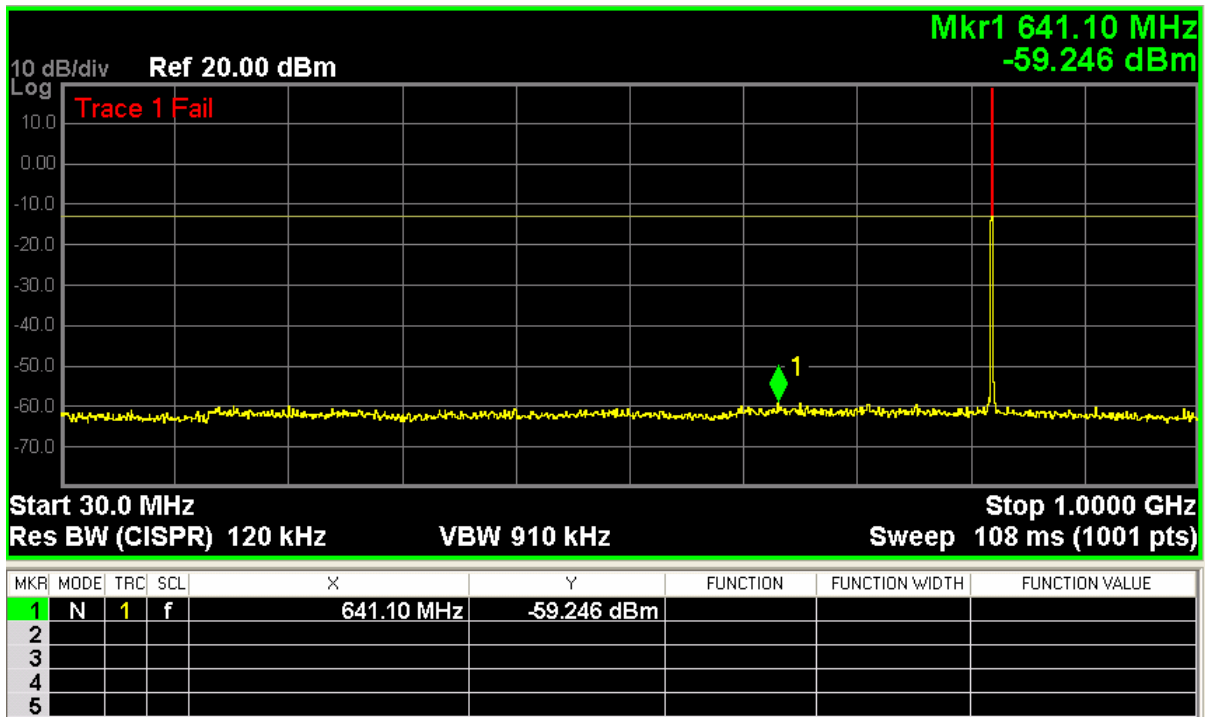

Note: The signal right of point 1 is carrier

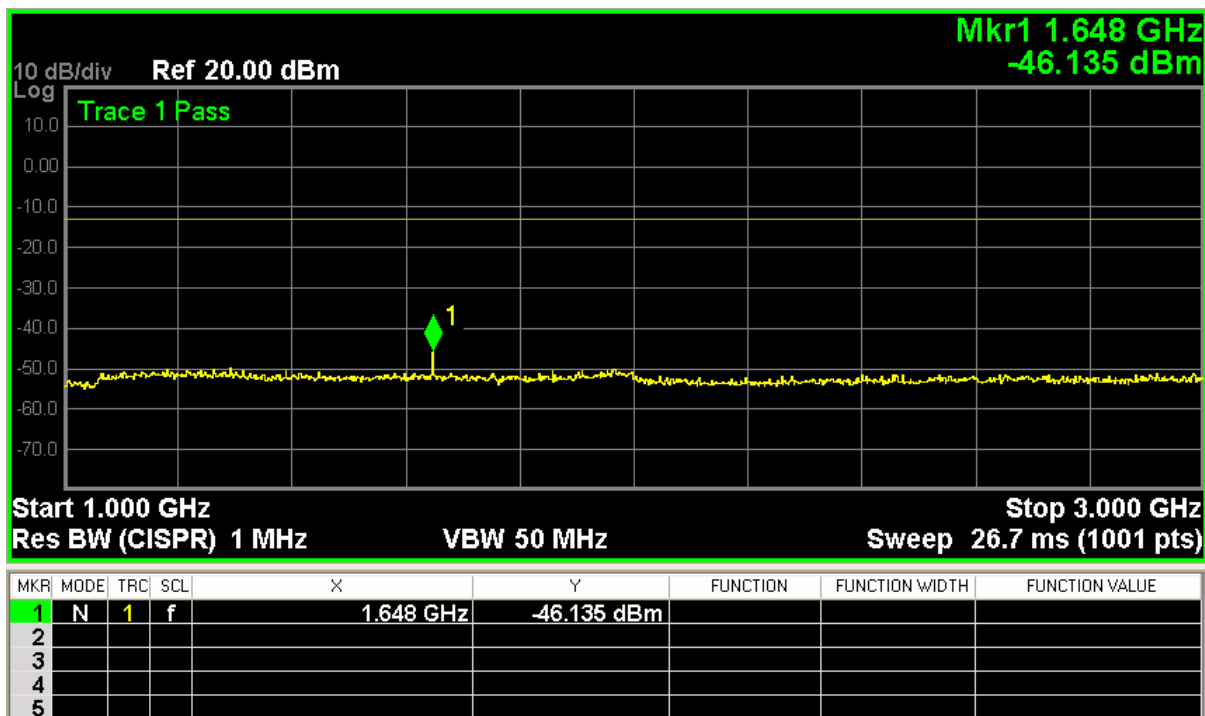

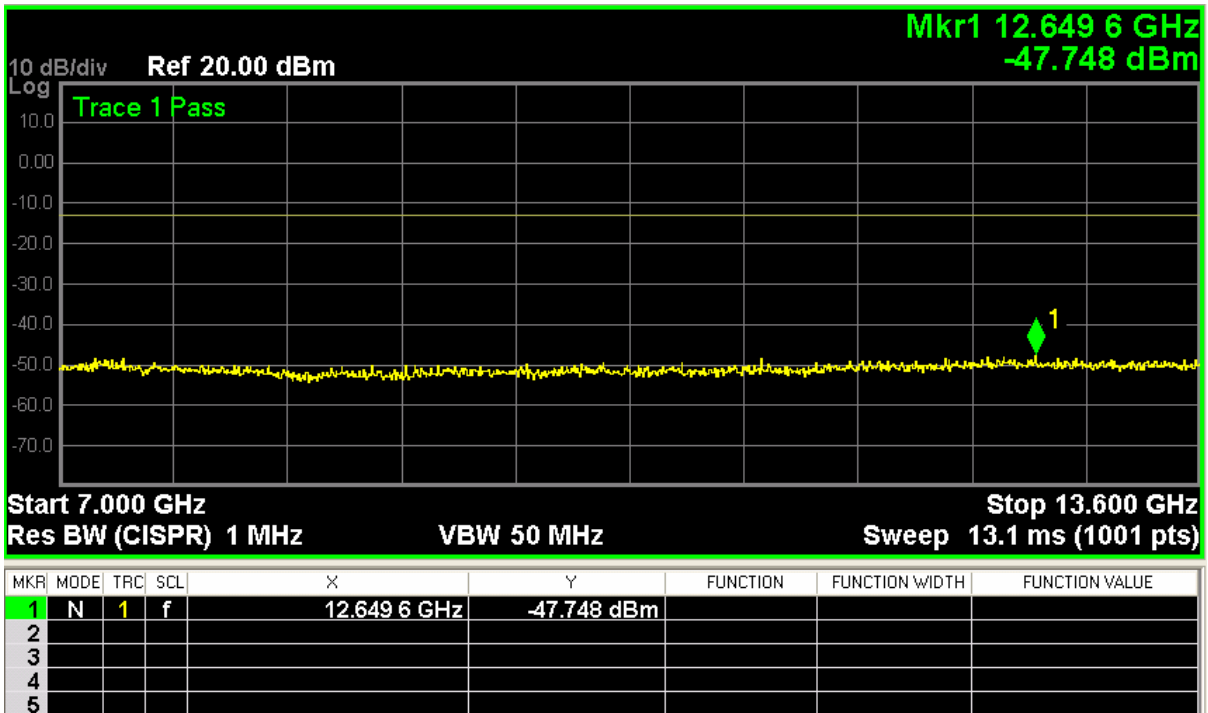
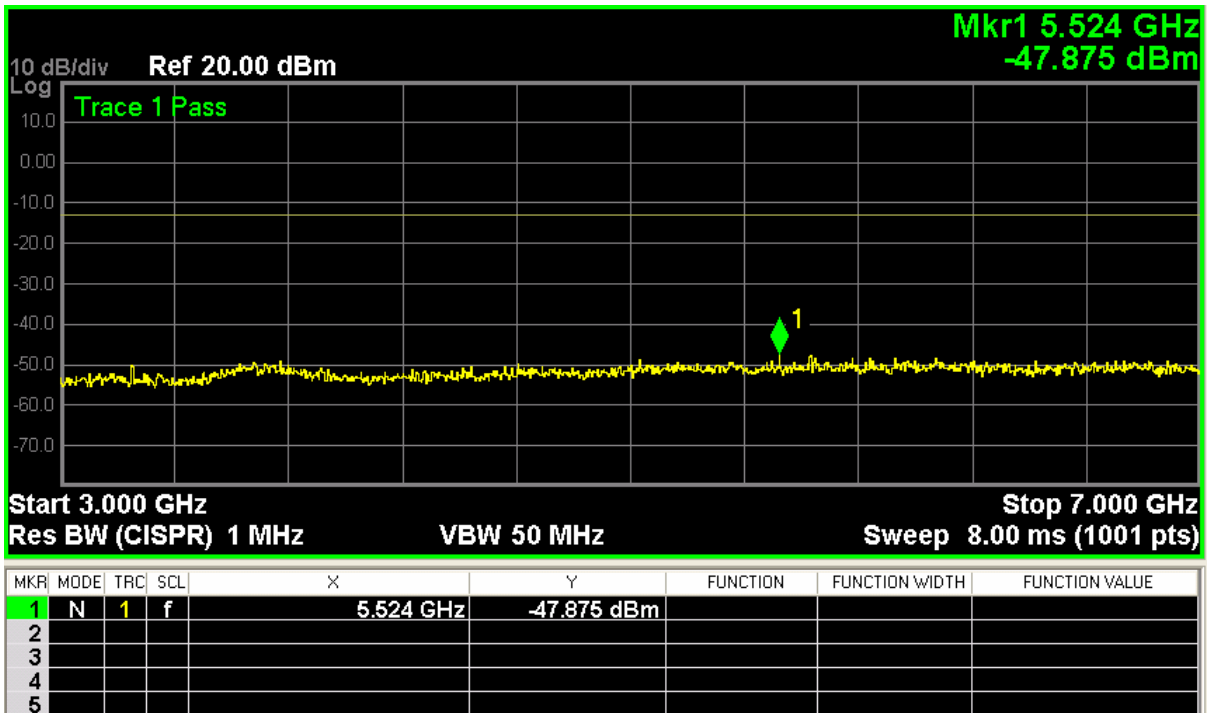

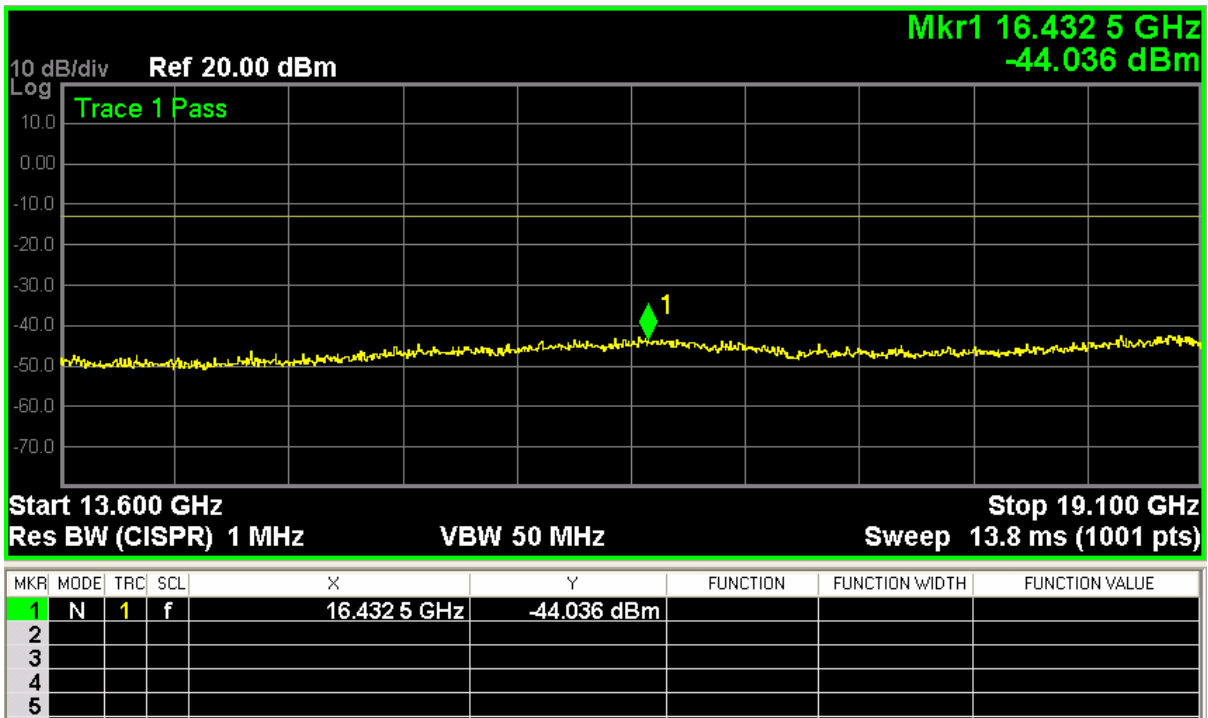

GPRS 1900 Channel 661

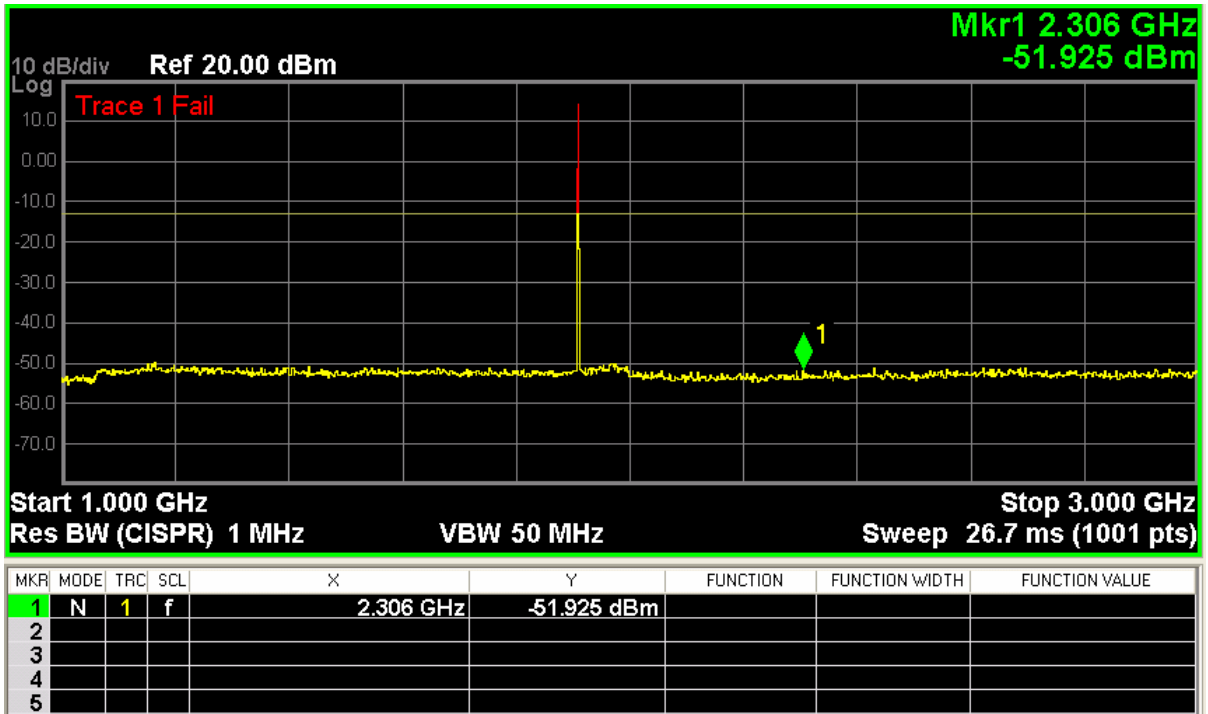

Note: The signal left of point 1 is carrier

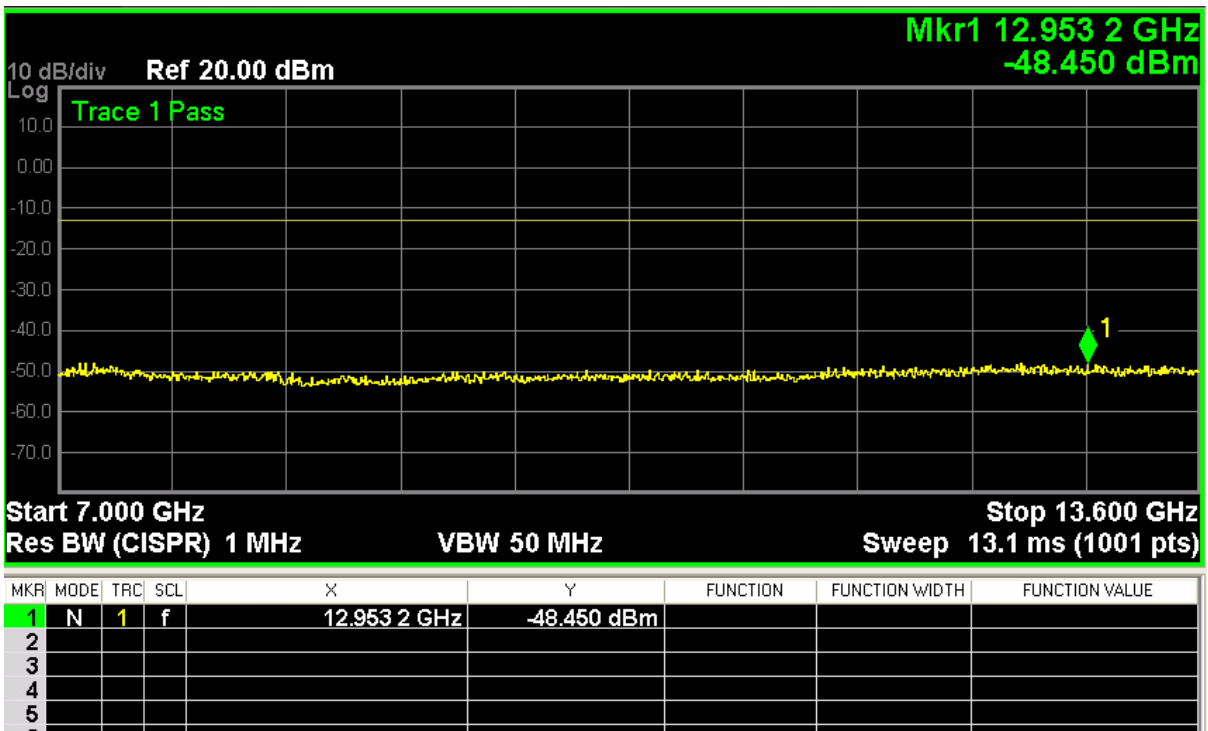
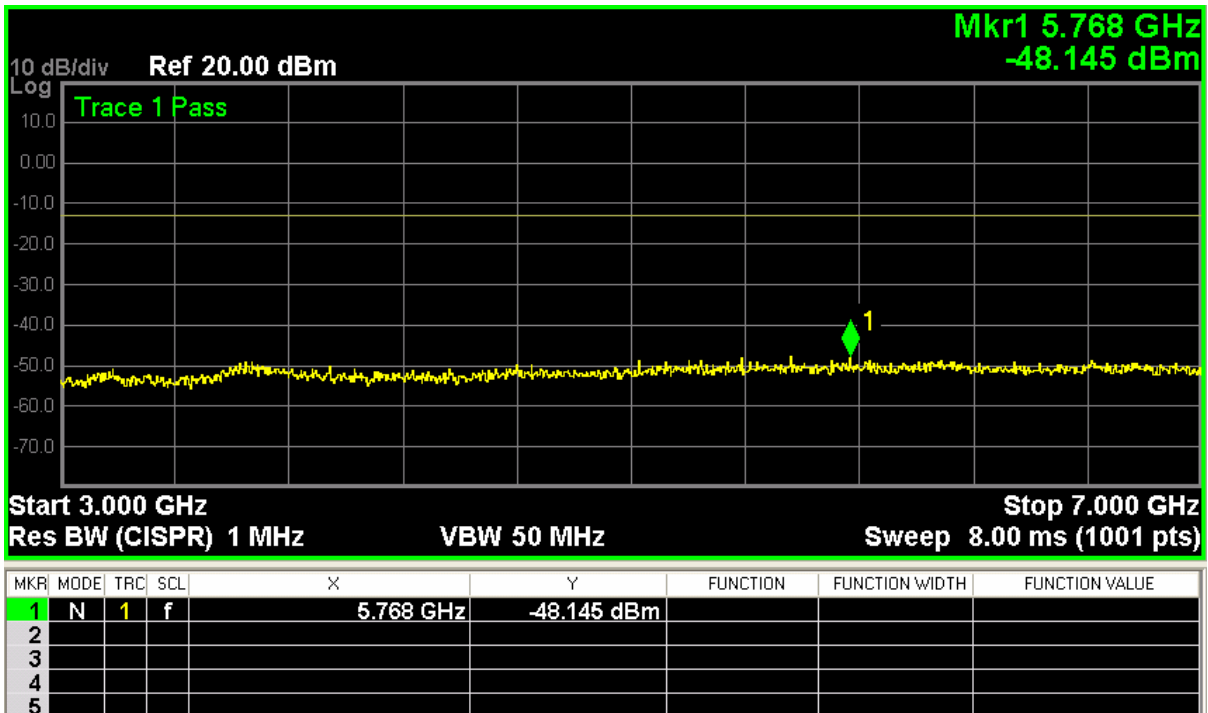

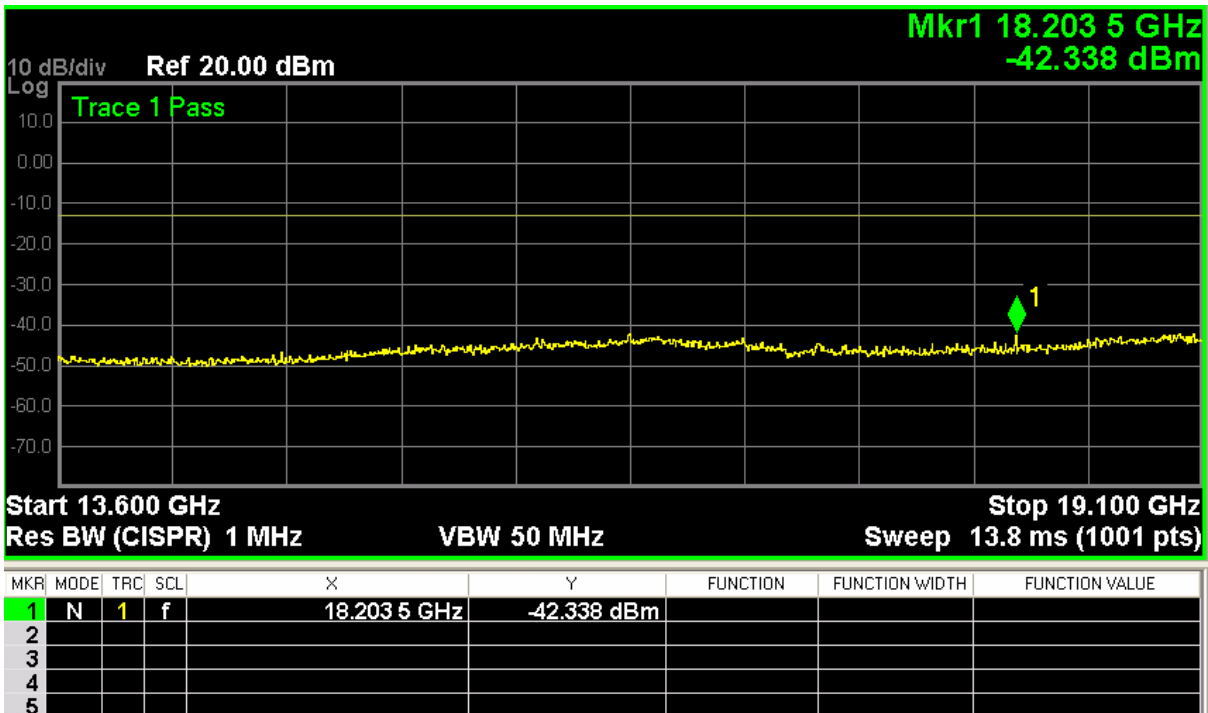

Radiated Spurious Measurement:

GSM850 Below 1GHz

Frequency (MHz)	Ant. (H/V)	Pol.	SG Reading (dBm)	Cable Loss (dB)	Gain (dBd)	ERP (dBm)
Middle Channel 189 (836.40MHz)						
148.7	H		-67.34	2.22	-0.71	-70.27
746.4	H		-66.25	3.56	-2.41	-72.22
148.7	V		-70.18	2.22	-0.71	-73.11
746.4	V		-70.6	3.56	-2.41	-76.57

GPRS 850 Above 1GHz

Frequency (MHz)	Ant. (H/V)	Pol.	SG Reading (dBm)	Cable Loss (dB)	Gain (dBd)	ERP (dBm)
Middle Channel 189 (836.40MHz)						
1668.4	H		-42.33	6.21	7.84	-40.7
2489.8	H		-40.4	7.46	8.21	-39.65
1668.4	V		-46.57	6.21	7.84	-44.94
2489.8	V		-36.21	7.46	8.21	-35.46

GPRS 850 Below 1GHz

Frequency (MHz)	Ant. (H/V)	Pol.	SG Reading (dBm)	Cable Loss (dB)	Gain (dBd)	ERP (dBm)
Middle Channel 189 (836.40MHz)						
148.7	H		-66.20	2.22	-0.71	-69.13
746.4	H		-64.87	3.56	-2.41	-72.17
148.7	V		-72.34	2.22	-0.71	-75.27
746.4	V		-71.54	3.56	-2.41	-77.51

GPRS 850 Above 1GHz

Frequency (MHz)	Ant. (H/V)	Pol.	SG Reading (dBm)	Cable Loss (dB)	Gain (dBd)	ERP (dBm)
Middle Channel 189 (836.40MHz)						
1668.4	H		-45.40	6.21	7.84	-43.77
2489.8	H		-42.10	7.46	8.21	-41.35
1668.4	V		-46.21	6.21	7.84	-44.58
2489.8	V		-40.64	7.46	8.21	-39.89

GSM1900 Below 1GHz

Frequency (MHz)	Ant. (H/V)	Pol.	SG Reading (dBm)	Cable Loss (dB)	Gain (dBi)	EIRP (dBm)
Middle Channel 661 (1880.00MHz)						
154.3	H		-64.50	2.23	1.14	-65.59
740.5	H		-62.31	3.42	-0.36	-66.09
154.3	V		-75.80	2.23	1.14	-78.39
740.5	V		-71.42	3.42	-0.36	-75.2

GSM 1900 Above 1GHz

Frequency (MHz)	Ant. (H/V)	Pol.	SG Reading (dBm)	Cable Loss (dB)	Gain (dBi)	EIRP (dBm)
Middle Channel 661 (1880.00MHz)						
3680.0	H		-52.50	8.47	12.50	-48.47
5360.5	H		-56.34	10.74	13.41	-53.67
3680.0	V		-53.40	8.47	12.50	-49.37
5360.5	V		-54.34	10.74	13.41	-51.67

GPRS 1900 Below 1GHz

Frequency (MHz)	Ant. (H/V)	Pol.	SG Reading (dBm)	Cable Loss (dB)	Gain (dBi)	EIRP (dBm)
Middle Channel 661 (1880.00MHz)						
154.3	H		-67.56	2.23	1.14	-68.65
740.5	H		-66.34	3.42	-0.36	-70.12
154.3	V		-74.95	2.23	1.14	-76.04
740.5	V		-71.05	3.42	-0.36	-74.83

GPRS1900 Above 1GHz

Frequency (MHz)	Ant. (H/V)	Pol.	SG Reading (dBm)	Cable Loss (dB)	Gain (dBi)	EIRP (dBm)
Middle Channel 661 (1880.00MHz)						
3680.0	H		-54.10	8.95	12.50	-50.55
5360.5	H		-58.42	11.12	13.41	-56.13
3680.0	V		-54.50	8.95	12.50	-50.95
5462.8	V		-56.31	11.12	13.41	-54.02

6.7. Test Photograph

Description: Conducted Spurious Emission Measurement Test Setup



Description: Radiated Spurious Measurement Test Setup (Below 1GHz)

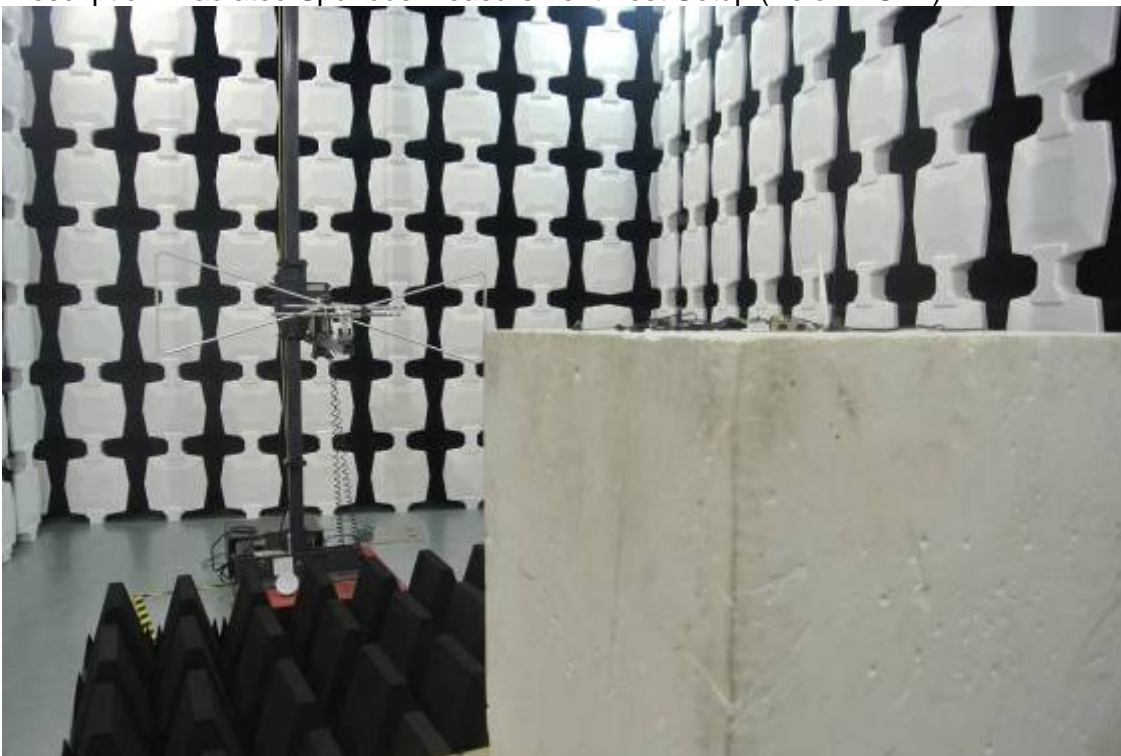

Description: Radiated Spurious Measurement Test Setup (Above 1GHz)



7. Frequency Stability Under Temperature & Voltage Variations

7.1. Test Equipment

Instrument	Manufacturer	Model	Serial No.	Cali. Due Date
Spectrum Analyzer	Agilent	N9038A	MY51210142	2013.09.27
Radio Communication Tester	Agilent	E5515C	GB46581718	2013.10.25
DC Power Supply	Agilent	6612C	MY43002989	2013.01.17
DC Power Supply	ITECH	IT5612	01600210661201014	2013.11.16
Temperature Chamber	WEISS	DU/20/40	58226017340050	2013.12.04

7.2. Test Setup

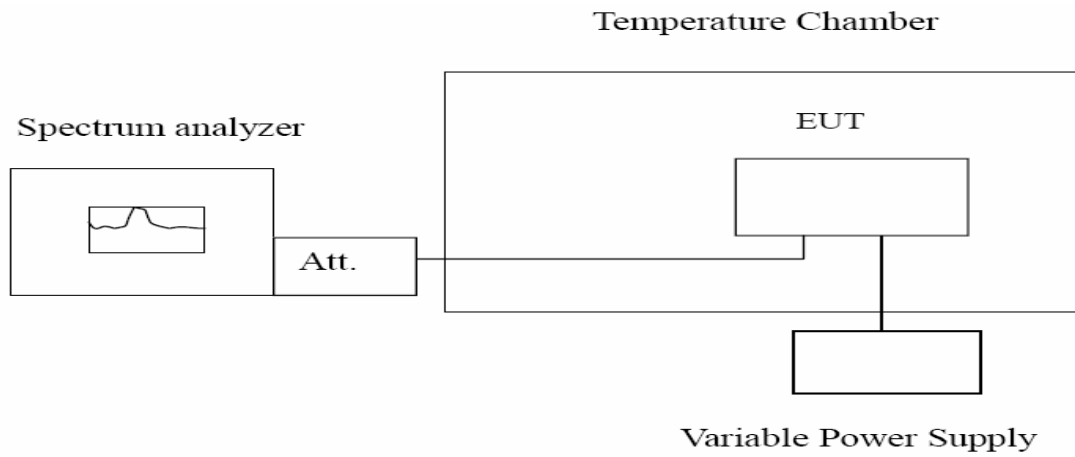

7.3. Limit

The frequency stability shall be sufficient to ensure that the fundamental emission stays within the authorized frequency block.

Limit	$< \pm 2.5 \text{ ppm}$
-------	-------------------------

7.4. Test Procedure

Frequency Stability Under Temperature Variations:

The equipment under test was connected to an external AC or DC power supply and input rated voltage. RF output was connected to a frequency counter or spectrum analyzer via feed through attenuators. The EUT was placed inside the temperature chamber. Set the spectrum analyzer RBW low enough to obtain the desired frequency resolution and measure EUT 20°C operating frequency as reference frequency. Turn EUT off and set the chamber

temperature to -30°C . After the temperature stabilized for approximately 30 minutes recorded the frequency. Repeat step measure with 10°C increased per stage until the highest temperature of $+50^{\circ}\text{C}$ reached.

Frequency Stability Under Voltage Variations:

Set chamber temperature to 20°C . Use a variable AC power supply / DC power source to power the EUT and set the voltage to rated voltage. Set the spectrum analyzer RBW low enough to obtain the desired frequency resolution and recorded the frequency.

Reduce the input voltage to specify extreme voltage variation ($\pm 15\%$) and endpoint, record the maximum frequency change.

7.5. Uncertainty

The measurement uncertainty is defined as ± 10 Hz.

7.6. Test Result

GSM 850

Frequency Stability under Temperature

Temperature Interval (°C)	Test Frequency (MHz)	Deviation (Hz)	Limit (Hz)
-30	836.40	-28	±2091
-20	836.40	-21	±2091
-10	836.40	-11	±2091
0	836.40	5	±2091
10	836.40	-10	±2091
20	836.40	-21	±2091
30	836.40	-14	±2091
40	836.40	-11	±2091
50	836.40	-13	±2091

Frequency Stability under Voltage

DC Voltage (V)	Test Frequency (MHz)	Deviation (Hz)	Limit (Hz)
3.6	836.40	-17	±2091
3.8	836.40	-21	±2091
4.2	836.40	-10	±2091

Notes: the manufacture declared that the EUT could work between voltages 3.6V~4.2 V.

GPRS 850

Frequency Stability under Temperature

Temperature Interval (°C)	Test Frequency (MHz)	Deviation (Hz)	Limit (Hz)
-30	836.40	-19	±2091
-20	836.40	-18.5	±2091
-10	836.40	-17	±2091
0	836.40	-12	±2091
10	836.40	-19	±2091
20	836.40	-10	±2091
30	836.40	-25	±2091
40	836.40	-6	±2091
50	836.40	-15	±2091

Frequency Stability under Voltage

DC Voltage (V)	Test Frequency (MHz)	Deviation (Hz)	Limit (Hz)
3.6	836.40	-16	±2091
3.8	836.40	-18	±2091
4.2	836.40	-27	±2091

Notes: the manufacture declared that the EUT could work between voltages 3.6V~4.2 V.

GSM 1900

Frequency Stability under Temperature

Temperature Interval (°C)	Test Frequency (MHz)	Deviation (Hz)	Limit (Hz)
-30	1880.00	17	±4700
-20	1880.00	12	±4700
-10	1880.00	-15	±4700
0	1880.00	-11.3	±4700
10	1880.00	-16.8	±4700
20	1880.00	15.3	±4700
30	1880.00	-11.5	±4700
40	1880.00	10.3	±4700
50	1880.00	21.5	±4700

Frequency Stability under Voltage

DC Voltage (V)	Test Frequency (MHz)	Deviation (Hz)	Limit (Hz)
3.6	1880.00	-18.6	±4700
3.8	1880.00	-30.4	±4700
4.2	1880.00	-19.4	±4700

Notes: the manufacture declared that the EUT could work between voltages 3.6V~4.2 V.

GPRS 1900

Frequency Stability under Temperature

Temperature Interval (°C)	Test Frequency (MHz)	Deviation (Hz)	Limit (Hz)
-30	1880.00	-21.6	±4700
-20	1880.00	-20.5	±4700
-10	1880.00	-20.4	±4700
0	1880.00	-18.6	±4700
10	1880.00	-20.8	±4700
20	1880.00	-17.1	±4700
30	1880.00	-30.5	±4700
40	1880.00	-40.5	±4700
50	1880.00	-42.3	±4700

Frequency Stability under Voltage

DC Voltage (V)	Test Frequency (MHz)	Deviation (Hz)	Limit (Hz)
3.6	1880.00	-14.2	±4700
3.8	1880.00	-20.8	±4700
4.2	1880.00	-21.4	±4700

Notes: the manufacture declared that the EUT could work between voltages 3.6V~4.2 V.

7.7. Test Photograph

Description: Frequency Stability Under Temperature & Voltage Variations Test Setup



8.Attachment

EUT Photograph

View of EUT-1



View of EUT-2



View of EUT-3

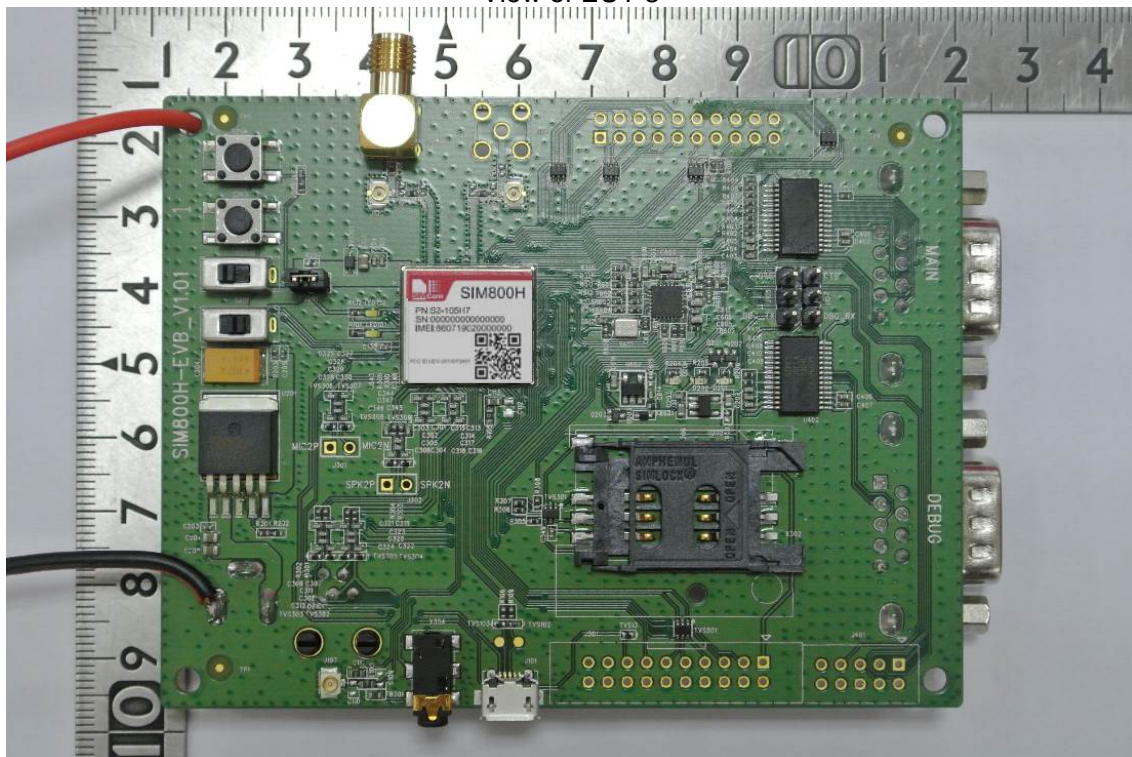

View of EUT-4



View of EUT-5



